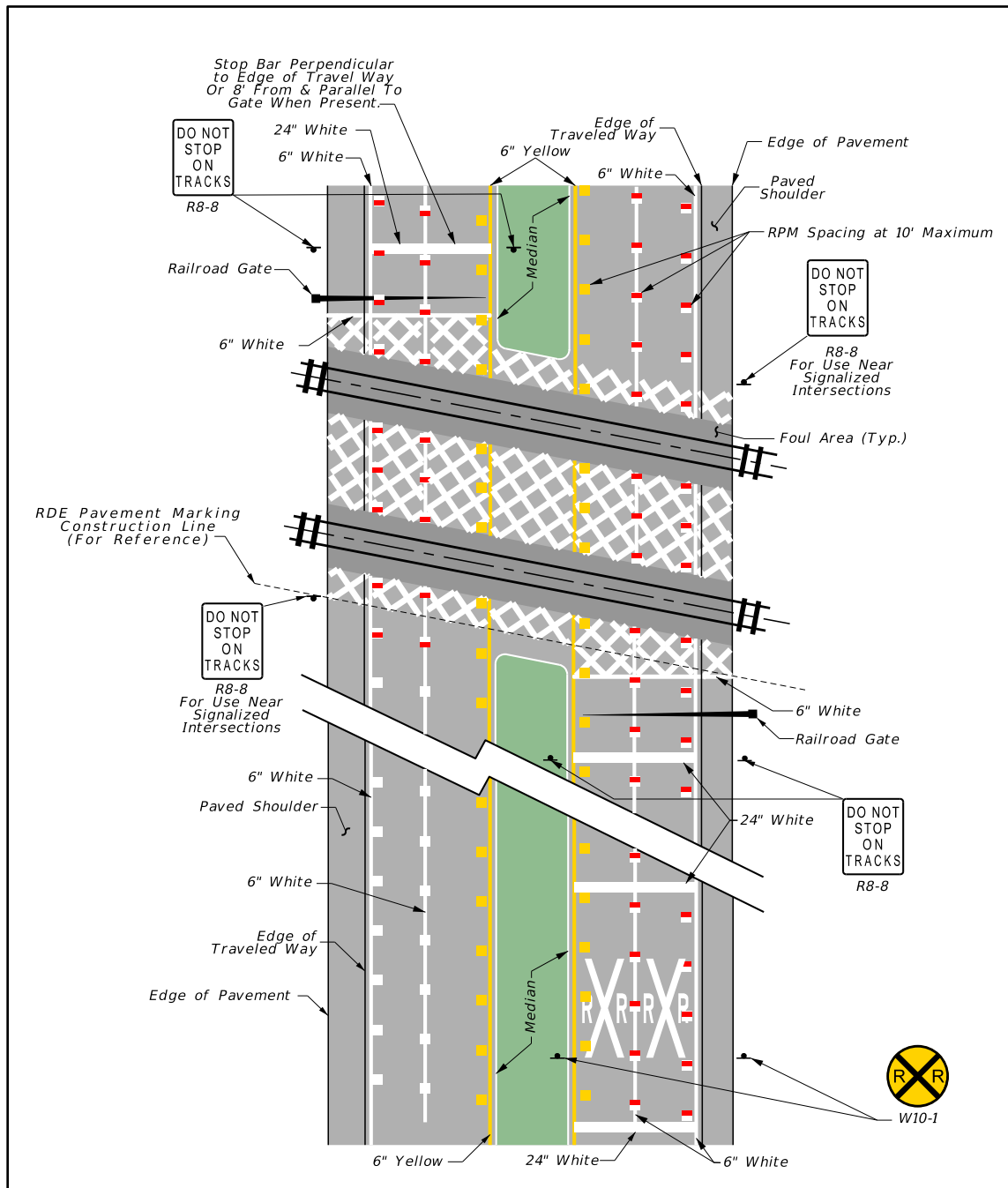
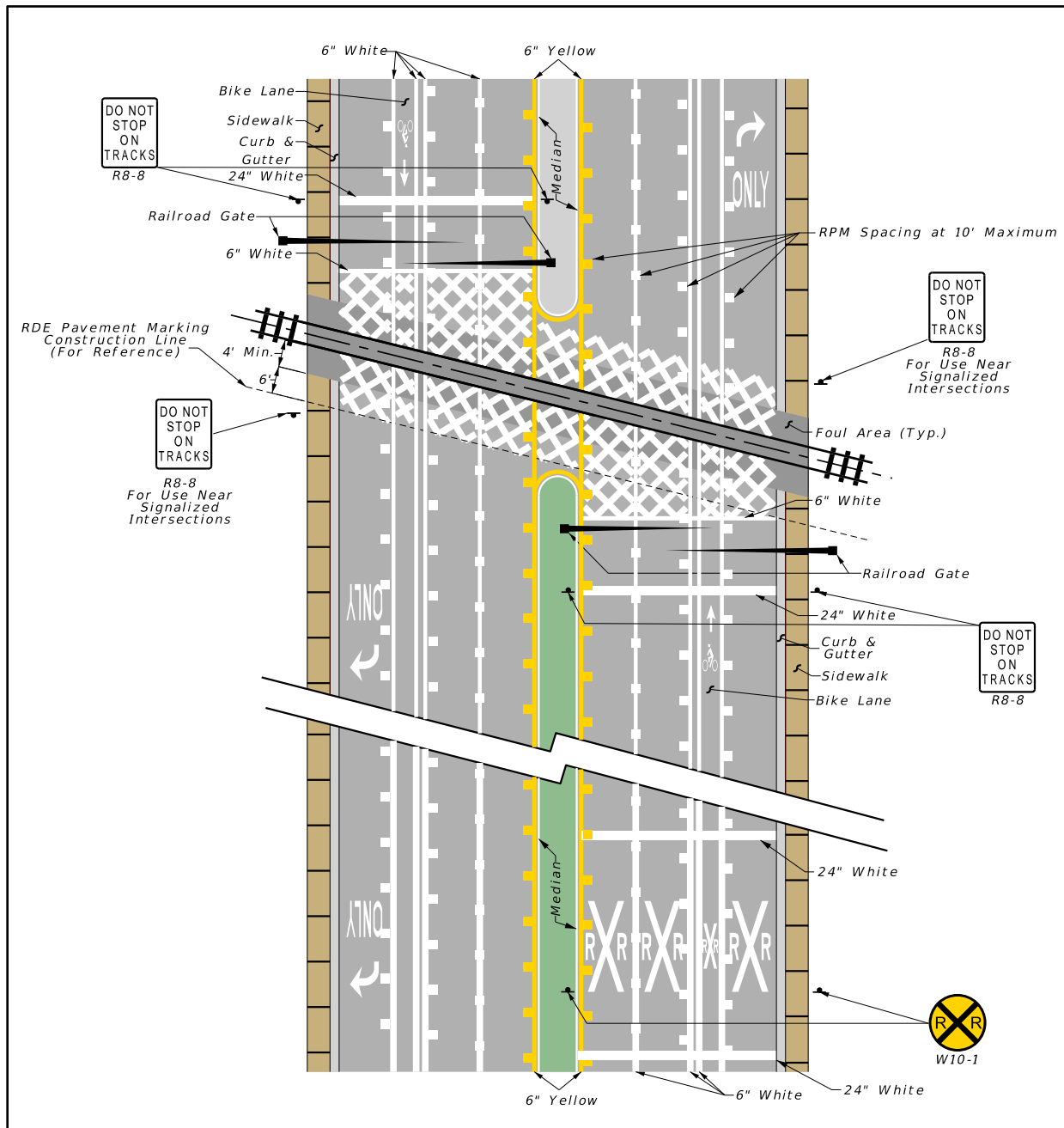

**Figure 7 – 11 Railroad Crossing at Multilane Roadway**



**Note:** 1. Dimensions not shown for clarity, see Figure 7 – 10 Railroad Crossing at 2 Lane Roadway.

**Figure 7 – 12 Railroad Crossing at Multilane Roadway with Right Turn Lane**



**Note:** 1. Dimensions not shown for clarity, see Figure 7 – 10 Railroad Crossing at 2 Lane Roadway.

**Table 7 – 4 Location of “Do Not Stop on Tracks” Signage for Railroad Crossings  
Using the Rail Dynamic Envelope**

<u>Design Speed (mph)</u>	<u>Distance “A (feet)”</u>
<u>60</u>	<u>400</u>
<u>55</u>	<u>325</u>
<u>50</u>	<u>250</u>
<u>45</u>	<u>175</u>
<u>40</u>	<u>125</u>
<u>35</u>	<u>100</u>
<u>Curbed</u>	<u>85 Min.</u>

.

## E QUIET ZONES

Quiet Zone means a segment of a rail line that includes public rail-highway crossings at which locomotive horns are not routinely sounded. The Federal Railroad Administration (FRA) has established guidelines the applying jurisdiction must follow for approval of quiet zones. Applying entities can go to the [FRA's website](#) and the [Code of Federal Regulations \(CFR\), Title 49, Subtitle B, Chapter II, Part 222](#) for further information on the process for approval of Quiet Zones.

Coordinate with the FDOT's District Rail Coordinator to determine if crossings are located within designated Quiet Zones for State owned rail corridors or crossings of state highways. State owned rail corridors include the Central Florida Rail Corridor and the South Florida Rail Corridor. For other rail crossings, coordinate with the local government who maintains the crossing roadway, sidewalk, or shared use path to determine if the location has been approved by the FRA for a Quiet Zone.

For a crossing within a Quiet Zone that requires supplemental safety measures, approved supplemental safety measures include:

- Temporary closure of a public railroad-highway-rail grade crossing.
- Four-quadrant gate systems.
- Gates with medians or channelization devices.
- One way street with gate(s); and
- Permanent closure of a public highway-rail grade crossing.

The [CFR, Title 49, Chapter II, Part 222, Appendix A, Approved Supplemental Safety Measures](#) provides additional information on the design of Quiet Zones to meet federal approval. The **CFR** also requires that any traffic control device and its application where used as part of a Quiet Zone shall comply with all applicable provisions of the **MUTCD**. See [MUTCD, Part 8, Traffic Control for Railroad and Light Rail Transit Grade Crossings](#) for further information. Pedestrian gates, audible device, and detectable warnings are required when a sidewalk or shared use path is present or proposed.

For Quiet Zones that cross state owned rail corridors, the [FDOT Design Manual, Chapter 220 Railroads](#) provides additional information.

Figure 7 – [139](#) Gate Configurations for Quiet Zones illustrates the maximum gap allowed for gates at rail-highway crossings within Quiet Zones, based upon **CFR, Title 49, Chapter II, Part 222**.

**Figure 7 – [139](#) Gate Configuration for Quiet Zones**

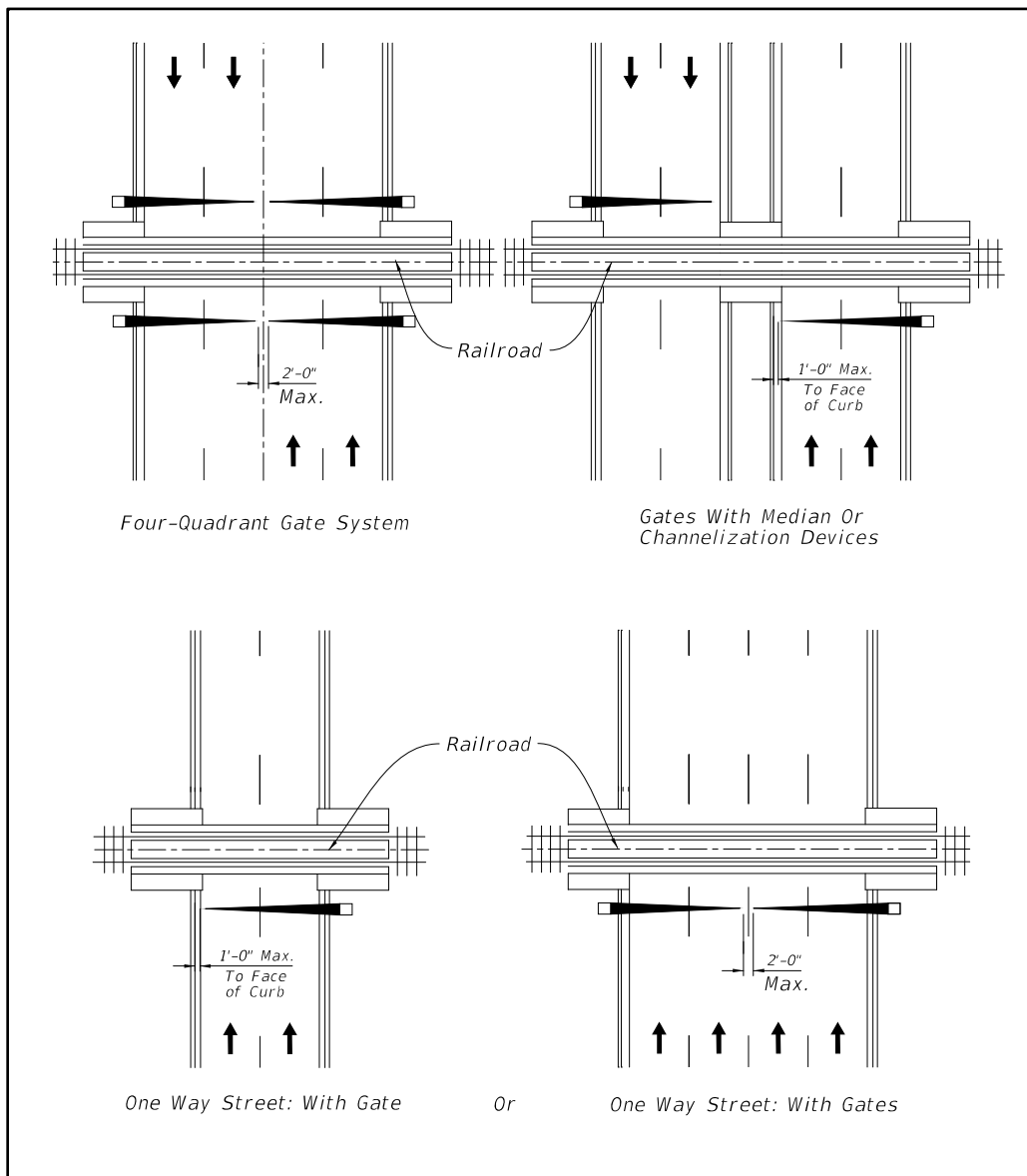

## F HIGH SPEED RAIL

The establishment of high-speed rail service is governed by **49 U.S. Code 26106 – High-Speed Rail Corridor Development**.

The [High-Speed Rail \(HSR\) Strategic Plan](#) divides potential operations into four categories or generic descriptions:

- HSR – Express. Frequent express service between major population centers 200 - 600 miles apart, with few intermediate stops. Top speeds of at least 150 mph on completely grade-separated, dedicated rights-of-way (with the possible exception of some shared track in terminal areas). Intended to relieve air and highway capacity constraints.
- HSR – Regional. Relatively frequent service between major and moderate population centers 100 - 500 miles apart, with some intermediate stops. Top speeds of 110 - 150 mph, grade-separated, with some dedicated and some shared track (using positive train control (PTC) technology). Intended to relieve highway and, to some extent, air capacity constraints.
- Emerging HSR. Developing corridors of 100 - 500 miles, with strong potential for future HSR Regional and/or Express service. Top speeds of up to 80 - 110 mph on primarily shared track (eventually using PTC technology), with advanced grade crossing protection or separation. Intended to develop the passenger rail market and provide some relief to other modes.
- Conventional Rail. Traditional intercity passenger rail services of more than 100 miles with as little as 1 to as many as 7 - 12 daily frequencies; may or may not have strong potential for future high-speed rail service. Top speeds of up to 79 mph generally on shared track. Intended to provide travel options and to develop the passenger rail market for further development in the future.

Further information on the implementation of high-speed rail service can be found on the Federal Railroad Administration's website [High Speed Rail Overview](#).

## G MAINTENANCE AND RECONSTRUCTION

The inspection and maintenance of all features of rail-highway grade crossings shall be an integral part of each highway agency's and railroad company's regular maintenance program (**Chapter 10 – Maintenance ~~a~~ And Resurfacing**). Items that should be given a high priority in this program include pavement stability and skid resistance, clear sight distance, and all traffic control and protective devices.

The improvement of all substandard or hazardous conditions at existing grade crossings is extremely important and should be incorporated into the regular highway reconstruction program. The objective of this reconstruction program should be to upgrade each crossing to meet these standards. The priorities for reconstruction should be based upon the guidelines set forth by the [FDOT Department](#).

## H REFERENCES FOR INFORMATIONAL PURPOSES

The following is a list of publications that for further guidance:

- Federal Highway Administration Railroad-Highway Grade Crossing Handbook, Revised Second Edition, August 2007  
<https://rosap.ntlhttps://rosap.ntl.bts.gov/view/dot>
- [http://safety.fhwa.dot.gov/xings/com\\_roaduser/07010/](http://safety.fhwa.dot.gov/xings/com_roaduser/07010/)
- Code of Federal Regulations (CFR), Title 49 Transportation, Part 222, Use of Locomotive Horns at Public Highway-Rail Grade Crossings  
[http://www.ecfr.gov/cgi-bin/text-idx?tpl=/ecfrbrowse/Title49/49cfr222\\_main\\_02.tpl](http://www.ecfr.gov/cgi-bin/text-idx?tpl=/ecfrbrowse/Title49/49cfr222_main_02.tpl)
- The Train Horn Rule and Quiet Zones  
<https://www.fra.dot.gov/Page/P0104>
- MUTCD, Part 8, Traffic Control for Railroad and Light Rail Transit Grade Crossings  
<http://mutcd.fhwa.dot.gov/pdfs/2009r1r2/part8.pdf>
- The American Railway Engineering and Maintenance-of-Way Association (AREMA)  
<https://www.arema.org/>
- Florida Administrative Code, (Rule 14-57: Railroad Safety and Clearance Standards, and Public Railroad-Highway Grade Crossings)  
<https://www.flrules.org/gateway/RuleNo.asp?title=RAILROAD SAFETY AND CLEARANCE STANDARDS, AND PUBLIC RAILROAD-HIGHWAY GRADE CROSSINGS&ID=14-57.011>
- Florida Department of Transportation Rail Contacts  
<https://www.fdot.gov/rail/contacts/staff.shtm>



**THIS PAGE INTENTIONALLY LEFT BLANK**

## CHAPTER 8

### PEDESTRIAN FACILITIES

A	INTRODUCTION .....	8-1
B	TYPES OF PEDESTRIAN FACILITIES .....	8-2
B.1	Sidewalks .....	8-2
B.2	Shared Use Paths .....	8-4
B.3	Shared Streets .....	8-4
B.4	Shoulders .....	8-4
C	MINIMIZING CONFLICTS .....	8-5
C.1	General Needs .....	8-5
C.2	Horizontal Separation .....	8-5
C.2.a	General Criteria .....	8-6
C.2.b	Buffer Widths .....	8-7
C.3	Other Considerations .....	8-7
D	BARRIER SEPARATION .....	8-8
D.1	Longitudinal Barriers .....	8-8
D.2	Fencing, Pedestrian Channelization Devices or Landscaping .....	8-9
E	GRADE SEPARATION .....	8-10
E.1	Overpasses .....	8-11
E.2	Underpasses .....	8-11
F	DROP-OFF HAZARDS FOR PEDESTRIANS .....	8-12
G	PEDESTRIAN CROSSINGS .....	8-14
G.1	Crosswalks .....	8-14
G.1.a	Marked Crosswalks .....	8-14
G.1.b	Midblock Crosswalks .....	8-16
G.2	Curb Ramps and Blended Transitions .....	8-18
G.3	Detectable Warnings .....	8-20
G.4	Curb Extensions .....	8-21
G.5	Pedestrian Signals .....	8-21

G.6	Sight Distance.....	8-21
G.7	Rail Crossings.....	8-22
H	LIGHTING.....	8-23
I	REFERENCES FOR INFORMATIONAL PURPOSES .....	8-25

## FIGURES

Figure 8 – 1	Shoulder Point with Sidewalk.....	8-6
Figure 8 – 2	Guardrail with Pipe Rail Detail .....	8-9
Figure 8 – 3	Pedestrian Bridge Typical Section .....	8-10
Figure 8 – 4	Drop-Off Hazards for Pedestrians and Bicyclists .....	8-13
Figure 8 – 5	Pedestrian Median Refuge with Curb Extension.....	8-15
Figure 8 – 6	Raised Midblock Crosswalk .....	8-16
Figure 8 – 7	Pedestrian Hybrid Beacon (PHB).....	8-17
Figure 8 – 8	Pedestrian Median Refuge with Rectangular Rapid Flashing Beacons .....	8-18

## CHAPTER 8

### PEDESTRIAN FACILITIES

#### A INTRODUCTION

Pedestrian facilities shall be given full consideration in the planning and development of transportation facilities, including the incorporation of such facilities into state, regional, and local transportation plans and programs under the assumption that transportation facilities will be used by pedestrians. Pedestrian facilities should be considered in conjunction with the construction, reconstruction, or other significant improvement of any transportation facility. Special emphasis should be given to projects in or within 1 mile of an urban area. Examples of pedestrian facilities include sidewalks, shared use paths, over and under passes, curb ramps, median refuges, and crosswalks.

In addition to the design criteria provided in this ~~manual~~chapter, the following documents provide criteria and guidance in the design of pedestrian facilities in the public right of way:

- United States Department of Transportation ADA ~~Americans with Disabilities Act~~ Standards for Transportation Facilities (2006) and as required by 49 C.F.R 37.41 or 37.43.
- United States Department of Justice ADA Standards (2010) as required by 28 C.F.R 35 (title II) and 36 (title III).
- Public Rights-of-Way Accessibility Guidelines (PROWAG) provides additional information for the design of pedestrian facilities.

~~The~~ and the 202017 Florida Accessibility Code for Building Code, Accessibility, 7th Edition Construction as required by 61G20-4.002 contains ADA requirements for accessibility to sites, facilities, buildings, and elements by people with disabilities ~~impose additional requirements for the design and construction of pedestrian facilities.~~

~~Examples of pedestrian facilities include sidewalks, shared use paths, over and under passes, curb ramps, median refuges, and crosswalks.~~

Each ~~transportation~~ ~~highway~~ agency responsible for a system of streets and highways should establish and maintain a program for implementing pedestrian facilities, and for maintaining existing pedestrian facilities.

## B TYPES OF PEDESTRIAN FACILITIES

There are several ways in which pedestrians can be accommodated in the public right of way.

### B.1 Sidewalks

Sidewalks are walkways parallel to the roadway and designed for use by pedestrians. Sidewalks should be provided along both sides of roadways that are in or within one mile of an urban area. If sidewalks are constructed on the approaches to bridges, they should be continued across the structure. If continuous sidewalks are constructed on only one side of the street, pedestrians should be provided access to facilities and services located on the opposite side of the street. Newly constructed, reconstructed, or altered sidewalks shall be accessible to and usable by persons with disabilities.

The minimum width of a sidewalk shall be 5 feet on both curb and gutter and flush shoulder roadways. The minimum separation for a 5-foot sidewalk from the back of curb is 2 feet. If the sidewalk is located adjacent to the curb, the minimum width of sidewalk is 6 feet. Provide a minimum 1-foot wide level graded area with a maximum slope of 1:6 along both sides of the sidewalk. This would not apply to the side of the sidewalk located immediately adjacent to a curb, structure or the right of way line. ~~For sidewalks, not adjacent to the curb, at least a 1-foot wide graded area should be provided on both sides, flush with the sidewalk and having a maximum 1:6 slope.~~ Wider sidewalks should be considered in Central Business Districts and in areas where heavy two-way pedestrian traffic is expected.

A 5-foot wide (minimum) sidewalk that connects a transit stop or facility with an existing sidewalk or shared use path shall be included to comply with ADA accessibility standards. **Chapter 13 – Transit** provides illustrations of the connection between the sidewalk and transit facility.

Particular attention shall be given to pedestrian accommodations at the termini of each project. If full accommodations cannot be provided due to the limited scope or phasing of a roadway project or an existing sidewalk is not present at the termini, an extension of the sidewalk to the next appropriate pedestrian crossing or access

point should be considered. If pedestrian facilities are provided, they shall be connected with facilities (e.g., sidewalks, shared use path, and crosswalks on the adjoining projects).

For new construction and reconstructed roadways, grades on sidewalks or shared use paths shall not exceed 5%, unless accessible ramps and landings are provided. However, in a roadway right of way, the grade of sidewalks or shared use paths is permitted to equal the general grade established for the adjacent street or highway. There should be enough sidewalk or path cross slope to allow for adequate drainage, however the maximum shall be no more than 2% to comply with ADA requirements.

Where existing physical constraints make it impracticable for altered elements, spaces, or facilities to fully comply with the requirements for new construction, compliance is required to the extent practicable within the scope of the project. Existing physical constraints include, but are not limited to, underlying terrain, right-of-way availability, underground structures, adjacent developed facilities, drainage, or the presence of a notable natural or historic feature.

The location of new poles or relocated poles shall provide at least 48" minimum unobstructed sidewalk width.

Evaluate existing driveways and turnouts for compliance to ADA requirements. Nonconforming driveways are not required to be upgraded if it is not feasible within the scope of the project.

~~Additional information on designing accessible pedestrian facilities is provided by the United States Access Board at the following web site:~~

~~[\*\*Proposed Guidelines for Pedestrian Facilities in the Public Right-of-Way\*\*](#)~~

Edge drop-offs should be avoided. When drop-offs cannot be avoided, they should be shielded as discussed in Section F, Drop-Off Hazards for Pedestrians.

For additional information concerning the design of sidewalks, refer to **Section C.7.d** of **Chapter 3 – Geometric Design**.

## **B.2 Shared Use Paths**

Paths are usually set back from the roadway and separated by a green area, ditch, swales, or trees. Shared use paths are intended for the use by both pedestrians and bicyclists and shall be accessible. For additional information concerning the design of shared-use paths, refer to **Chapter 9 – Bicycle Facilities**.

## **B.3 Shared Streets**

Shared uses of a street for people walking, bicycling, and driving are referred to as shared streets. These are usually specially designed spaces such as pedestrian streets which are local urban streets with extremely low vehicle speed.

## **B.4 Shoulders**

Highway shoulders are not intended for frequent use by pedestrians, but do accommodate occasional pedestrian traffic. Highway shoulders often have cross slopes which exceed 2%; consequently, they are not considered or expected to fully meet ADA criteria.

## **C MINIMIZING CONFLICTS**

The planning and design of new streets and highways shall include provisions that support pedestrian travel and minimize vehicle-pedestrian conflicts. These may include:

- Sidewalks and/or shared use paths parallel to the roadway
- Marked pedestrian crossings
- Raised median or refuge islands
- Pedestrian signal features such as pedestrian signal heads and detectors
- Transit stops and shelters

In some situations, it may be possible to eliminate a vehicle-pedestrian conflict through close coordination with the planning of pedestrian facilities and activity outside of the highway right of way. Care should be exercised to ensure the elimination of a given conflict point does not transfer the problem to a different location. Any effort to minimize or eliminate conflict points must consider the mobility needs of the pedestrian. The desired travel path should not be severed and the number of required crossing points and/or walking distances should not be significantly increased. Some crossings should be redesigned rather than eliminated or relocated.

### **C.1 General Needs**

Minimizing vehicle-pedestrian conflicts can be accomplished by providing adequate horizontal, physical, or vertical (primarily for crossings) separation between the roadway and the pedestrian facility.

### **C.2 Horizontal Separation**

The development of independent systems for pedestrian and motor vehicular traffic is the preferred method for providing adequate horizontal separation.



### C.2.a General Criteria

New sidewalks should be placed as far from the roadway as practical in the following sequence of desirability:

1. As near the right of way line as possible. (ideally, 3 feet of width should be provided behind the sidewalk for above ground utilities)
2. Outside of the clear zone.
3. Sufficiently off-set from the curb to allow for the placement of street trees, signs, utilities, parking meters, benches, or other street furniture outside of the sidewalk in urban locations (e.g., town center, business, or entertainment district).
4. Five feet from the shoulder point on flush shoulder roadways.
5. At the grass shoulder point of flush shoulder roadways.

Figure 8 – 1 Shoulder Point with Sidewalk provides an illustration of the location of the shoulder point.

On arterial or collector roadways, sidewalks shall not be constructed contiguous to the roadway pavement, unless a curb or other barrier is provided. Nearing intersections, the sidewalk should be transitioned as necessary to provide a more functional crossing location that also meets driver expectation. Further guidance on the placement of stop or yield lines and crosswalks is provided in the [MUTCD, Part 3](#).

**Figure 8 – 1 Shoulder Point with Sidewalk**

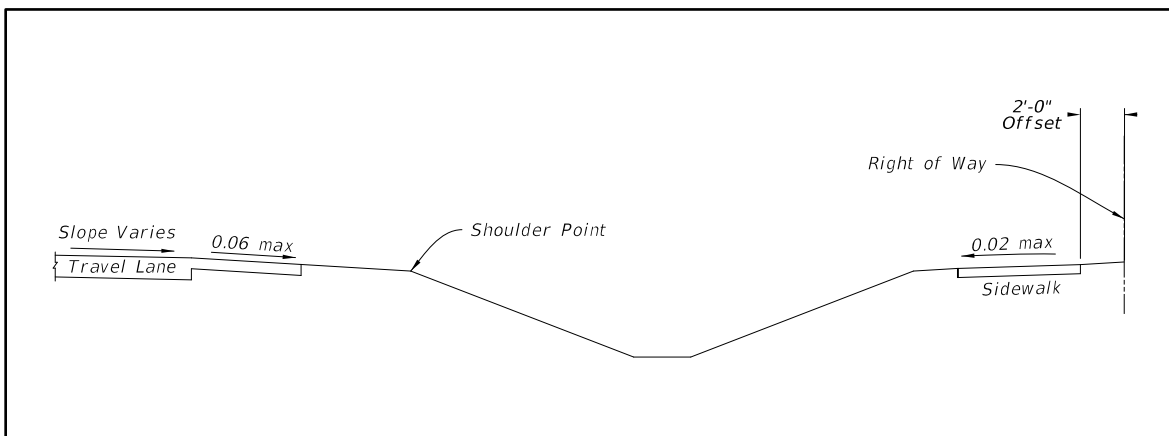

### **C.2.b Buffer Widths**

Providing a buffer can improve pedestrian safety and enhance the overall walking experience. Buffer width is defined as the space between the sidewalk and the edge of traveled way. On-street parking or bike lanes can also act as an additional buffer. The planting strip or buffer strip should be 6 feet where practical to eliminate the need to narrow or reroute sidewalks around driveways. With this wider buffer strip, the sidewalk is placed far enough back so that the driveway slope does not have to encroach into the sidewalk.

### **C.3 Other Considerations**

When designing urban highways, the following measures may be considered to help increase the safe and efficient operation of the highway for pedestrians:

- Use narrower lanes and introduce raised medians to provide pedestrian refuge areas
- Provide pedestrian signal features and detectors
- Prohibit right turn on red
- Control, reduce, or eliminate left and/or right turns
- Prohibit free flow right turn movements
- Reduce the number of lanes

## D BARRIER SEPARATION

Barriers may be used to assist in the separation of motor vehicular and pedestrian traffic.

### D.1 Longitudinal Barriers

Longitudinal barriers such as guardrails, rigid barriers, and bridge railings are designed primarily to redirect errant vehicles away from roadside hazards. These barriers can also be used to provide valuable protection of pedestrian facilities from out-of-control vehicles.

Where adequate horizontal separation is not feasible, or where there is a significant hazard from out-of-control vehicles, longitudinal barriers may be utilized. If electing to use barriers, special consideration should be made to ensure proper sight distance near driveways and intersections is maintained. See Chapter 4, Figure 4 – 8 Location of Guardrail for information on the correct placement of a sidewalk in conjunction with a guardrail.

When a new sidewalk or shared use path is within 4 feet of the back of a guardrail with steel posts, a pipe rail ~~shall~~ould be installed on the back of the post. For a guardrail with timber posts, the bolt ends ~~shall~~ould be trimmed flush with the post or recessed. See Figure 8 – 2 Guardrail with Pipe Rail Detail for an illustration of when a pipe rail is needed. Additional information on the design of guardrails adjacent to a sidewalk or shared use path can be found in the FDOT ~~Department~~Standard Plans. ~~Index 536-001~~ FDOT Design Standards, Index 400.

**Figure 8 – 2 Guardrail with Pipe Rail Detail**

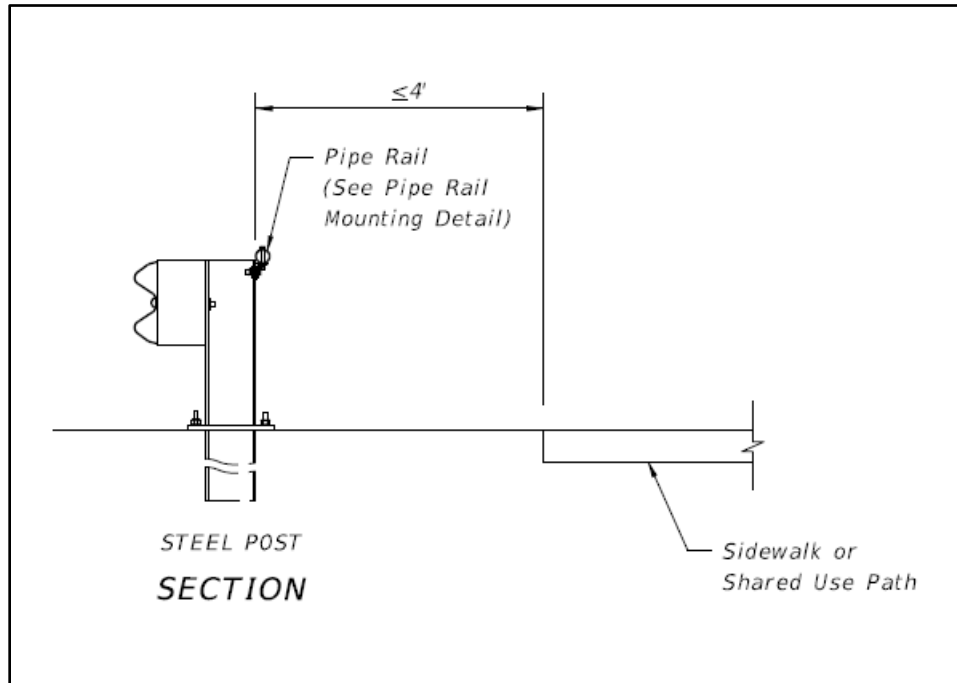

## **D.2 Fencing, Pedestrian Channelization Devices or Landscaping**

Fencing, pedestrian channelization devices or landscaping may be used to discourage pedestrian access to the roadway and aid in channeling pedestrian traffic to the proper crossing points. These should not be considered a substitute for longitudinal barriers, but may be used in conjunction with redirection devices.

## E GRADE SEPARATION

Grade separation may be selectively utilized to support the crossing of large pedestrian volumes across highways where the traffic volume on the roadway is at or near capacity or where speeds are high. Overpasses or underpasses may be justified at major pedestrian generators such as schools, shopping centers, sports and amusement facilities, transit centers, commercial buildings, parks and playgrounds, hospitals, and parking facilities.

The minimum clear width of any stand-alone pedestrian overpass or underpass on a pedestrian accessible route is 8 feet. However, if the contiguous sidewalk or path is greater than 8 feet wide, the clear width of the overpass or underpass should match that width. The minimum clear height of a pedestrian overpass or underpass is 8 feet. See Figure 8 – 3 Pedestrian Bridge Typical Section for an example of a pedestrian bridge typical section.

The FDOT [Structures Manual - Volume 1 - Structures Design Guidelines \(SDG\), Section 10](#) provide additional guidance on engineered steel and concrete pedestrian bridges.

**Figure 8 – 3 Pedestrian Bridge Typical Section**

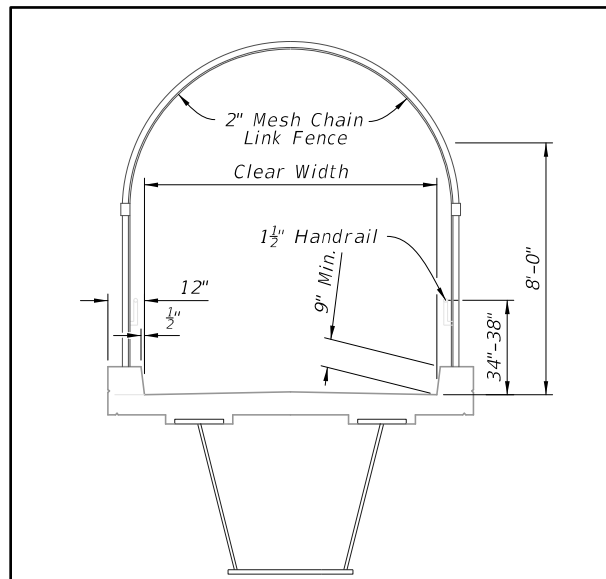

Notes: 1. Pedestrian handrails may be required. See the [2006 Americans with Disabilities Act Standards for Transportation Facilities](#).

2. Other superstructure configurations may be used provided an 8 ft. minimum headroom is maintained.

## **E.1 Overpasses**

Pedestrian overpasses are typically bridge structures over major roadways or railroads. Overpasses should provide elevator access if they are not designed to provide accessible ramps with compliant slopes, level landings, and handrails on both sides. Bridges over roadways should be covered or screened to reduce the likelihood of objects being dropped or thrown below. The area adjacent to overpasses may be fenced to prevent unsafe crossings and to channel pedestrians to the overpass structure.

## **E.2 Underpasses**

Pedestrian underpasses or tunnels perform the same function as overpasses. Their use is convenient when the roadway is elevated above the surrounding terrain.

Underpasses should be adequately maintained to reduce potential problems in lighting, cleaning, policing, and flooding and to maximize safety. The area adjacent to underpasses may be fenced to prevent unsafe crossings and to channel pedestrians to the underpass structure.

## **F DROP-OFF HAZARDS FOR PEDESTRIANS**

Drop-off hazards are defined as steep or abrupt downward slopes that can be perilous to pedestrians and bicyclists. Consider shielding any drop-off determined to be a hazard. Care should be taken when using Pedestrian/Bicycle Railings or fencing near intersections or driveways as they could obstruct the driver's line of sight. To reduce the need for railings as a sidewalk or shared use path approaches an intersection, consider extending cross drains and side drains to minimize drop-offs.

There are two cases that require shielding as shown in Figure 8 – 4 Drop-Off Hazards for Pedestrians and Bicyclists. Depending on the depth of the drop-off and severity of the conditions below, shielding may be necessary for cases other than described above.

Railings or fences should be provided for vertical drop-off hazards or where shielding is required. The standard height for a pedestrian/bicycle railing is 42 inches. A 48 inch tall pedestrian/bicycle railing should be used when sidewalk grades are steeper than 5% and bicycle travel is expected. A standard railing is generally intended for urbanized areas, locations attaching to bridge rail or along concrete walkways. Fencing is generally intended for use in rural areas along paths and trails.

**Figure 8 – 4 Drop-Off Hazards for Pedestrians and Bicyclists**

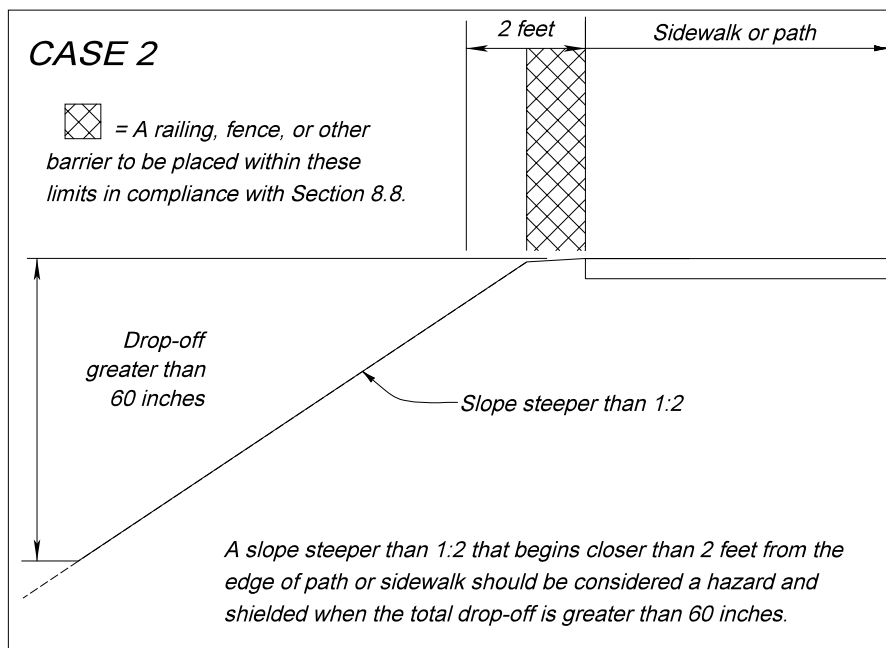
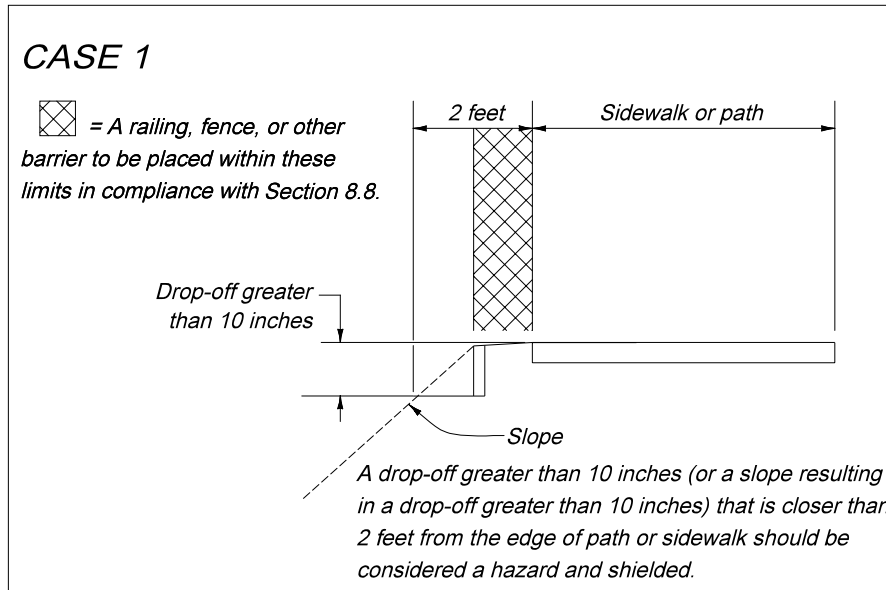



## G PEDESTRIAN CROSSINGS

The design of pedestrian crossings and parallel pathways within the right of way shall be considered an integral part of the overall design of a street or highway.

The development of protection at any remaining crossings or conflict points must be adequate to achieve a total pedestrian transportation mode that is reasonably safe.

### G.1 Crosswalks

The design of pedestrian crosswalks ~~shall~~<sup>should</sup> be based on the following requirements:

- Crosswalks should be placed at locations with sufficient sight distances
- At crossings, the roadway should be free from changes in alignment or cross section
- The entire length of crosswalk shall be visible to drivers at a sufficient distance to allow a stopping maneuver
- Stop bars or yield markings, in conjunction with the appropriate signing, shall be provided at all marked crosswalks
- Crosswalks shall be easily identified and clearly delineated, in accordance with the [Manual on Uniform Traffic Control Devices \(MUTCD\)](#) and [Rule 14-15.010, F.A.C.](#)

#### G.1.a Marked Crosswalks

Marked crosswalks are one tool to allow pedestrians to cross the roadway safely. They are often used in combination with other treatments (signs, flashing beacons, curb extensions, pedestrian signals, raised median or refuge islands, and enhanced overhead lighting). Marked crosswalks serve two purposes: 1) to inform motorists of the location of a pedestrian crossing so that they have time to lawfully yield to or stop for a crossing pedestrian; and 2) to assure the pedestrian that a legal crosswalk exists at a particular location. See Figure 8 – 5 Pedestrian Median Refuge with Curb Extensions for an example of a pedestrian median refuge with a curb extension.

## Figure 8 – 5 Pedestrian Median Refuge with Curb Extension



Urban Street Design Guide,  
National Association of City Transportation Officials (NACTO)

Marked crosswalks on an uncontrolled leg of an intersection or a mid-block location shall be supplemented with other treatments (such as signing, beacons, curb extensions, raised medians, raised traffic islands, or enhanced overhead lighting) when any of the following conditions exist:

1. Where posted speeds are greater than 40 mph.
2. On a roadway with 4 or more lanes without a raised median or raised traffic island that has an ADT of 12,000 or greater.
3. On a roadway with 4 or more lanes with a raised median or raised traffic island that has or is projected to have (within 5 years) an ADT of 15,000 or greater.

See **Chapter 6 – Lighting** for information on illuminating crosswalks and pedestrian facilities.

Additional guidance on marked crosswalks can be found in the [AASHTO Guide for the Planning, Design, and Operation of Pedestrian Facilities](#) and [FHWA's Safety Effects of Marked vs. Unmarked Crosswalks at Uncontrolled Locations: Executive Summary and Recommended Guidelines](#).

Marked crosswalks can also be used to create midblock crossings.

### G.1.b Midblock Crosswalks

Midblock crosswalks facilitate crossings to places that people want to go but that are not well served by the existing sidewalk or path network. These pedestrian crossings commonly occur at schools, parks, museums, waterfronts, and other destinations. Designers should study both existing and projected pedestrian volumes in assessing warrants for midblock crossings to account for latent demand.

Midblock crossings are located according to a number of factors including pedestrian volume, traffic volume, roadway width, traffic speed and type, desired paths for pedestrians, land use, and to accommodate transit connectivity. Midblock crossings should not be installed where sight distance or sight lines are limited for either the motorist or pedestrian.

Midblock crossings should be marked and signed in accordance with the [MUTCD](#). See Figure 8 – 6 Raised Midblock Crosswalks for an example of a midblock crosswalk.

**Figure 8 – 6 Raised Midblock Crosswalk**



Suwannee Street, Tallahassee, Florida

Crosswalks may be supplemented with Pedestrian Hybrid Beacons (PHB) or Rectangular Rapid Flashing Beacons (RRFBs). Illumination should be evaluated if night-time pedestrian activity is expected. See **Chapter 6 – Lighting** for further information.

A PHB is a special type of beacon used to warn and control traffic at an unsignalized location to assist pedestrians in crossing a street or highway at a marked crosswalk. [Chapter 4F. Pedestrian Hybrid Beacons, MUTCD](#) provides additional information regarding their installation. See Figure 8 – 7 Pedestrian Hybrid Beacon for an example of a pedestrian hybrid beacon.

**Figure 8 – 7 Pedestrian Hybrid Beacon (PHB)**



16<sup>th</sup> Street South, St. Petersburg, Florida

The RRFB uses rectangular-shaped high-intensity LED-based indications, flashes rapidly in a wig-wag "flickering" flash pattern, and is mounted immediately between the crossing sign and the sign's supplemental arrow plaque. Use of PHBs should be limited to locations with the most critical safety concerns, such as pedestrian and school crosswalks across uncontrolled approaches.

The use of RRFBs requires interim approval from FHWA. The [MUTCD](#) provides further information on obtaining [interim approval](#) for the use of [RRFBs](#). See Figure 8 – 8 Pedestrian Median Refuge with Rectangular Rapid Flashing Beacon for an example of a Rectangular Rapid Flashing Beacon (RRFB).

**Figure 8 – 8 Pedestrian Median Refuge with Rectangular Rapid Flashing Beacons (RRFB)**



4th Street North, St. Petersburg, Florida

## G.2 Curb Ramps and Blended Transitions

A continuous accessible pedestrian route, including curb ramps and blended transitions is needed along pedestrian networks. Blended transitions are raised pedestrian street crossings, depressed corners, or similar connections between pedestrian access routes at the level of the sidewalk or shared use path and level of the pedestrian street crossing that have a grade of 5% or less. Blended transitions can be used when geometrics and allocated space doesn't allow for separated curb ramps.

Curb ramps shall be provided at all intersections with curb (**Section 336.045 (3), Florida Statutes**). Each crossing should have separate curb ramps, perpendicular with the curb, and landing within the crosswalk. Include sidewalk curb ramps at the following locations:

- At curbed returns for intersections and turnouts. ~~Include a landing at the top of each ramp.~~
- On curbed roadways between intersections where a crosswalk has been established, such as midblock crossings and side streets.

Relocate or adjust pull boxes, manholes and other types of existing surface features to meet the ADA requirements for nonslip top surfaces, ¼ inch height protrusion, and slopes flush with the surrounding surface.

On sidewalks, the curb ramp width shall be a minimum of 4 feet; curb ramp widths equal to crosswalk widths are encouraged. For shared use paths, the curb ramp shall be at least as wide as the approaching width of the path. Curb ramp slopes shall not exceed 1:12 and shall have a firm, stable, slip resistant surface texture.

Curb ramps should be in line with the crossing. At intersections where more than one road is crossed, provide separate curb ramps at both ends of each crossing. Two ramps per corner are preferred to minimize the problems with entry angle and to decrease the delay to pedestrians entering and exiting the roadway.

Crossings are required to meet the same grade and cross slope requirements as sidewalks. Where criteria for maximum cross slope of the crossing cannot be met, provide the minimum attainable cross slope. When following the profile grade of the roadway, curb ramps ~~slopes are not required to exceed~~ ~~should not~~ 15 feet in length.

Curb ramps whose sides have returned curbs on the outside edges provide useful directional cues when they are aligned with the pedestrian street crossing and are protected from cross travel by a buffer area or landscaping.

Provide transition slopes (flared sides) where a pedestrian circulation path crosses the curb ramp. The maximum slope of transition slopes is 1:10, measured parallel with and adjacent to the curb line.

A turning space at least 4 feet by 4 feet wide shall be provided at the top of the curb ramp and shall be permitted to overlap other turning spaces and clear spaces. Where the turning space is constrained at the back-of-sidewalk, the turning space shall be at least 4 feet by 5 feet. The 5-foot dimension shall be provided in the direction of the ramp run.

When altering an existing pedestrian facility and conditions preclude the accommodation of a curb ramp slope of 1:12, provide a slope from 1:12 to 1:10 with a maximum rise of 6 inches.

Further information on curb ramps, landings and blended transitions is provided in the FDOT [Department's Standard Plans, Index 522-002](#).

### **G.3 Detectable Warnings**

Install detectable warnings to cover the full width of the walking surface and 2 feet in length. They are required on sidewalks and shared use paths at the following locations:

- Curb ramps and blended transitions at street crossings
- Cut-through pedestrian refuge islands or medians six feet wide or greater
- Pedestrian at-grade rail crossings
- Commercial driveways with a stop sign, yield sign or traffic signal
- Boarding and alighting areas adjacent to the roadway at bus stops where there is an at-grade connection to the roadway
- Edges of rail boarding platforms not protected by screens or guards

Detectable warnings are not required where sidewalk intersects urban flared turnouts or sidewalks that run continuously through driveways. Do not place detectable warnings on transition slopes or over grade breaks.

The detectable warning systems on the Department's **Approved Product List (APL)** are designed to work with concrete surfaces. In areas where the pedestrian facility has an asphalt surface, such as a shared use path, specify an appropriate detectable warning system. In these cases, consider including a short section of concrete that will accommodate any system.

Further information on detectable warnings are provided in the [FDOT Department's \*Standard Plans, Index 522-002\*](#).

## **G.4 Curb Extensions**

Curb extensions (a.k.a., bulb-outs) may be used in conjunction with on-street parking at intersections or midblock locations where there is a crosswalk, provided there is adequate width for existing traffic movements. Curb extensions shorten the crossing distance, and provide additional space at intersections, allowing pedestrians to see and be seen before entering a crosswalk. The design of curb extensions must take into consideration the needs of transit vehicles, drainage, and bicyclists.

## **G.54 Pedestrian SignalsControls**

Signs, signals, and markings should be utilized to provide the necessary information and direction for pedestrians. All directions and regulations should be clear, consistent, and logical, and should, at a minimum, conform to the requirements given in the [MUTCD](#). The installation use of accessible pedestrian signals that include audible and/or vibro-tactile, and visual signals should be considered ~~for pedestrian traffic control and regulation~~.

Where pedestrian facilities are provided or planned, include provisions (e.g., conduit, conductors, signal cables, push button pedestals, curb ramps) needed for future installation of Accessible Pedestrian Signal (APS) devices on all new and reconstructed signalized intersections and signalized crossing locations.

Provide a level landing at the base of all pedestrian pushbutton locations. The landing must provide a clear area of 30 inches by 48 inches (in either direction) directly in front of and centered on, the pedestrian pushbutton to allow persons using a wheeled mobility device to actuate the button while remaining stationary.

## **G.65 Sight Distance**

The general requirements for sight distances for the driver are given in **Chapter 3 - Geometric Design**.

Stopping sight distances greater than the minimum should be provided at all pedestrian crossings. These sight distances should include a clear view of the pedestrian approach pathway. Where parallel pedestrian pathways are within the



roadside recovery area, or where casual pedestrian crossings are likely, the normal required stopping sight distance should also include a clear view of the entire roadside recovery area.

Sight distances shall be based upon a driver's eye and object height as discussed in **Chapter 3 – Geometric Design**. Due to the small size of some pedestrians (particularly children), they are generally easy to confuse with other background objects.

Parking shall be prohibited where it would interfere with the required sight distance. Particular care should be exercised to ensure ample mutual sight distances are provided at all intersections and driveways.

### **G.76 Rail Crossings**

Roadways, sidewalks, and shared use paths at grade may cross light rail, street car rail, passenger rail, and freight railroads. Special design considerations are needed for these pedestrian intersections so that pedestrians are warned of the crossing and potential presence of a train. In addition, these crossings have specific accessibility requirements relating to surface continuity which must be met. See **Chapter 7 – Rail-Highway Crossings** for further information. The [Federal Railroad Administration](#) may impose additional requirements for the design and construction of rail crossings.

## H LIGHTING

Lighting of the roadway itself is not only important for the safety of vehicular traffic, but also valuable for the protection of pedestrians. Vehicle headlamps often do not provide sufficient lighting to achieve the required stopping sight distance. Since this requirement is of vital importance at any potential pedestrian crossing point, lighting of the crossing should be considered. Lighting a street or highway is also valuable in improving the pedestrian's view of oncoming vehicles. At intersections or other locations with vehicle turning maneuvers, vehicle headlights may not be readily visible to the pedestrian.

Lighting shall be provided in pedestrian underpasses and should be considered on pedestrian overpasses. All pedestrian lighting shall be vandal resistant. The installation of daytime lighting is warranted when underpass user visibility requirements are not met with sunlight. Pedestrian underpass and overpass lighting should conform to the general lighting requirements given in the American Association of State Highway and Transportation Officials (AASHTO) Roadway Lighting Design Guide.

The general requirements for lighting on streets and highways are given in **Chapter 6 – Lighting**. Pathways adjacent to a street or highway should not be illuminated to a level more than twice that of the roadway itself.

*In general, lighting should be considered as warranted when it is necessary, at night, to* provide the mutual sight distance capabilities described in the preceding **Chapter 3 – Geometric Design**. Locations with significant night time pedestrian traffic that should be considered for lighting of the roadway and adjacent pedestrian facilities include the following:

- Any street or highway that meets the warranting criteria given in **Chapter 6 – Lighting**
- Streets and highways with speed limits ~~in excess of~~ more than 40 mph that do not have adequate pedestrian conflict elimination
- Sections of highway with minimal separation of parallel pedestrian pathways
- Intersections, access and decision points, and areas adjacent to changes in alignment or cross sections
- Areas adjacent to pedestrian generators
- Transit stops and other mass transit transfer locations
- Parking facilities

- Entertainment districts, sports/recreation complexes, schools, and other activity centers generating night travel
- Pedestrian crossings
- Any location where improvement of night time sight distance will reduce the hazard of vehicle-pedestrian conflicts

See **Chapter 6 – Lighting** for further information on lighting of pedestrian facilities and shared use paths.

## I REFERENCES FOR INFORMATIONAL PURPOSES

- Florida Department of Transportation Transit Facility Design  
<http://www.dot.state.fl.us/transit/Pages/NewTransitFacilitiesDesign.shtm>  
<https://www.fdot.gov/fdottransit/transitofficehome/transitplanning.shtm/newtransitfacilitiesdesign.shtm>
- USDOT/FHWA ADA Standards for Accessible Design (ADAAG)  
<http://www.access-board.gov/guidelines-and-standards/buildings-and-sites/about-the-ada-standards/ada-standards>
- 2006 Americans with Disabilities Act Standards for Transportation Facilities  
<https://www.access-board.gov/files/ada/ADAdotstandards.pdf>
- 2012 Florida Accessibility Code for Building Construction  
<https://www.flrules.org/gateway/ruleno.asp?id=61G20-4.002>  
[http://floridabuilding.org/fbc/committees/accessibility/aac/Changes to Law/Florida Accessibility Code 2012 ICC FINAL.pdf](http://floridabuilding.org/fbc/committees/accessibility/aac/Changes%20to%20Law/Florida%20Accessibility%20Code%202012%20ICC%20FINAL.pdf)
- [AASHTO – Guide for the Planning, Design, and Operation of Pedestrian Facilities](https://store.transportation.org/)  
<https://store.transportation.org/>
- AASHTO – Roadway Lighting Design Guide †  
<https://store.transportation.org/>
- NACTO Urban Streets Design Guide  
<https://nacto.org/publication/urban-street-design-guide/>
- [Designing Walkable Urban Thoroughfares \(CNU and ITE\)](https://www.cnu.org/our-projects/cnu-ite-manual)  
<https://www.cnu.org/our-projects/cnu-ite-manual>
- FHWA Policy Memo for Flexibility in Pedestrian and Bicycle Facility Design  
[https://nacto.org/wp-content/uploads/2013/09/design\\_flexibility\\_memorandum\\_092013.pdf](https://nacto.org/wp-content/uploads/2013/09/design_flexibility_memorandum_092013.pdf)
- AASHTO Load and Resistance Factor Design (LRFD) Bridge Design Specifications, 6<sup>th</sup> Edition, (2012) with 2013 Interim Revisions  
<https://store.transportation.org/>
- Federal Railroad Administration General Manual - Policies, Procedures, and General Technical Bulletins (July 2014)  
<https://railroads.dot.gov/about-fra/about-fra>

## CHAPTER 9

### BICYCLE FACILITIES

A	INTRODUCTION .....	9-1
B	ON-STREET FACILITIES.....	9-2
	B.1    Bicycle Lanes.....	9-2
	B.2    Buffered Bicycle Lanes .....	9-19
	B.3    Bicycle Lane with Bus Bay .....	9-22
	B.4    Separated Bicycle Lanes .....	9-23
	B.5    Green Colored Bicycle Lanes .....	9-24
	B.6    Paved Shoulders.....	9-30
	B.7    Wide Outside Lanes.....	9-30
	B.8    Shared Lane Markings.....	9-31
	B.9    Bicycles May Use Full Lane Sign .....	9-34
C	SHARED USE PATHS .....	9-35
	C.1    Width and Clearance.....	9-36
	C.2    Separation Between Shared Use Paths and Roadways .....	9-37
	C.3    Design Speed .....	9-38
	C.4    Horizontal Alignment.....	9-38
	C.5    Accessibility .....	9-38
	C.6    Shared Use Path – Roadway Intersections.....	9-39
	C.6.a    Grade Separated Crossings.....	9-40
	C.6.b    Sidepath Crossings.....	9-41
	C.6.c    Midblock Shared Use Path Crossings.....	9-42
	C.6.c.1    Intersections with Yield Control .....	9-42
	C.6.c.2    Intersections with Signal Control or Stop Control.....	9-45
	C.7    Structures.....	9-45
	C.8    Pavement Markings and Signage .....	9-45

D	RAILROAD CROSSINGS.....	9-46
E	STRUCTURES.....	9-48
F	REFERENCES FOR INFORMATIONAL PURPOSES .....	9-49

## TABLES

Table 9 – 1	Lane Widths Urban Multilane or Two-Lane with Curb and Gutter .....	9-8
Table 9 – 2	Formulas for Lengths of Roadway and Path Legs – Yield Condition .	9-43
Table 9 – 3	Intersection Sight Distance Calculated Lengths of Roadway and Path Lengths.....	9-44

## FIGURES

Figure 9 – 1	Minimum Widths for Bicycle Lanes .....	9-3
Figure 9 – 2	Detail of Bicycle Lane Markings .....	9-4
Figure 9 – 3	Bicycle Lanes.....	9-5
Figure 9 – 4	Left Side Bicycle Lanes.....	9-6
Figure 9 – 5	Example of Obstruction Pavement Markings .....	9-7
Figure 9 – 6	Bicycle Lane Markings .....	9-9
Figure 9 – 7	Bicycle Lanes with Separate Right Turn Lane (Curb and Gutter) .....	9-10
Figure 9 – 8	Bicycle Lanes with On Street Parking, No Right Turn Lane (Curb and Gutter).....	9-11
Figure 9 – 9	Bicycle Lane with Right Turn Drop Lane (Curb and Gutter).....	9-12
Figure 9 – 10	"Tee" Intersection with Bicycle Lane, Separate Right and Left Turn Lanes (Curb and Gutter).....	9-13
Figure 9 – 11	"Tee" Intersection with Bicycle Lanes, Left Turn Lane and Right Turn Drop Lane (Curb and Gutter).....	9-14
Figure 9 – 12	Bicycle Lanes with No Right Turn Lane (Flush Shoulder).....	9-15
Figure 9 – 13	Bicycle Lane with Separate Right Turn Lane (Flush Shoulder).....	9-16
Figure 9 – 14	Bicycle Lanes with Bus Bay, No Right Turn Lane (Curb and Gutter) .	9-17
Figure 9 – 15	Bicycle Lanes on Interchange Ramps (Flush Shoulder) .....	9-18
Figure 9 – 16	Buffered Bicycle Lane Adjacent to On-Street Parking.....	9-19
Figure 9 – 17	Buffered Bicycle Lane Markings.....	9-20
Figure 9 – 18	Buffered Bicycle Lane Markings with On-Street Parking.....	9-21
Figure 9 – 19	Buffered Bicycle Lane with Bus Bay Marking (Curb and Gutter).....	9-22
Figure 9 – 20	Green Bicycle Lane with Separate Right Turn Lane .....	9-26

Figure 9 – 21 Green Bicycle Lane with Right Turn Drop Lane ..... 9-27

Figure 9 – 22 Green Bicycle Lane with Channelized Right Turn Lane ..... 9-28

Figure 9 – 23 Green Bicycle Lane with Bus Bay ..... 9-29

Figure 9 – 24 Shared Lane Marking ..... 9-31

Figure 9 – 25 Shared Lane Marking Placement (No Designated Parking, Lane Width ≤ 14 Feet).....9-32

Figure 9 – 26 Shared Lane Marking Placement (With On-Street Parking)..... 9-33

Figure 9 – 27 Mid-Block and Sidepath Crossings Relative to Intersection Functional Area.....9-40

Figure 9 – 28 Yield Sight Triangles ..... 9-42

Figure 9 – 29 Sign Placement on Shared Use Paths ..... 9-46



## CHAPTER 9

### BICYCLE FACILITIES

#### A INTRODUCTION

Bicycle facilities ~~shall~~~~ould~~ be given full consideration in the planning and development of transportation facilities, including the incorporation of such facilities into state, regional, and local transportation plans, and programs under the assumption that transportation facilities will be used by cyclists. Bicycle facilities should be established in conjunction with the construction, reconstruction, or other change of any transportation facility and special emphasis should be given to projects in or within 1 mile of an urban area. The provision for bicycle facilities ~~i~~s also desirable for resurfacing, restoration & rehabilitation (RRR) projects.

Bicycle and pedestrian facilities are not required to be established:

1. Where their establishment would be contrary to public safety.
2. When the cost would be excessively disproportionate to the need or probable use;  
or
3. Where other available means or factors indicate an absence of need.

Appropriately designed and located bicycle facilities play an important role in supporting bicycle travel. Bicyclists ~~shall~~~~ould~~ be considered in all phases of transportation planning, design, construction, and maintenance activities. ~~Particular~~~~E~~emphasis should be given to new construction, reconstruction, intersection improvement, and transit projects. Bicycle facilities can include bicycle lanes, paved shoulders, wide curb lanes, shared lanes, shared use paths, and bicycle parking facilities.

In addition to the design criteria provided in this chapter, shared use paths and structures that include provisions for pedestrians shall be designed to be accessible to persons with disabilities. For more information on accessible design requirements, see Chapter 8 – Pedestrian Facilities. ~~the 2006 Americans with Disabilities Act Standards for Transportation Facilities as required by 49 C.F.R 37.41 or 37.43 and the 2017 Florida Accessibility Code for Building Construction as required by 61G20-4.002 impose additional requirements for the design and construction of facilities such as shared use paths and structures that include provisions for pedestrians.~~

## B ON-STREET FACILITIES

Provisions for bicycle traffic should be incorporated in the original roadway design. All roadways, except where bicycle use is prohibited by law, should be designed, constructed, and maintained under the assumption they will be used by bicyclists. Roadway conditions should be favorable for bicycling, with smooth pavement and limited changes in elevation along edge lines. Drainage inlets and utility covers that cannot be moved out of the travel way ~~shall~~ should be designed flush with grade, well seated, and make use of bicycle-compatible grates and covers.

Railroad grade crossings on a diagonal can cause steering difficulties for bicyclists. Crossings for bicycle facilities should be perpendicular to the rail. This can be accomplished with a widened shoulder or bicycle lane, or separate path. Consideration ~~shall~~ should be given to improving the smoothness of the crossing and reducing the width and depth of the flangeway opening. Flangeway fillers can be used on heavy rail lines to minimize the size of the opening adjacent to the rail.

Bicycle lanes, paved shoulders, wide curb lanes, or shared lanes should be included to the fullest extent feasible. The appropriate selection of a bicycle facility depends on many factors, including motor vehicle and bicycle traffic characteristics, adjacent land use and expected growth patterns. All new or reconstructed arterial and collector roadways, in and within one mile of an urban area, should include bicycle lanes.

Rumble strips used in a traffic lane to alert operators to conditions ahead (e.g., stop signs, traffic signals or curves) should provide clear space (free of rumble strips) for bicyclists. This clear space may be a paved shoulder or if no paved shoulder is present, a minimum of 1.5 feet of clear space at the outermost portion of the lane.

### B.1 Bicycle Lanes

Bicycle lanes delineate available roadway space for preferential use by bicyclists, providing more predictable movements by motorists and bicyclists. Bicycle lanes also help increase the total capacity of highways carrying mixed bicycle and motor vehicle traffic. Bicycle lanes shall have a minimum functional width of 4 feet. At least 1-foot additional width is needed when the bicycle lane is adjacent to a curb or other barrier, on-street parking is present, there is substantial truck traffic (>10%), or posted speeds exceed 50 mph. Minimum bicycle lane widths are illustrated in Figure 9 – 1 Minimum Widths for Bicycle Lanes. The 4-foot bicycle lane shown in the flush shoulder typical section assumes the grass portion of the shoulder provides emergency maneuvering room.

**Figure 9 – 1 Minimum Widths for Bicycle Lanes**

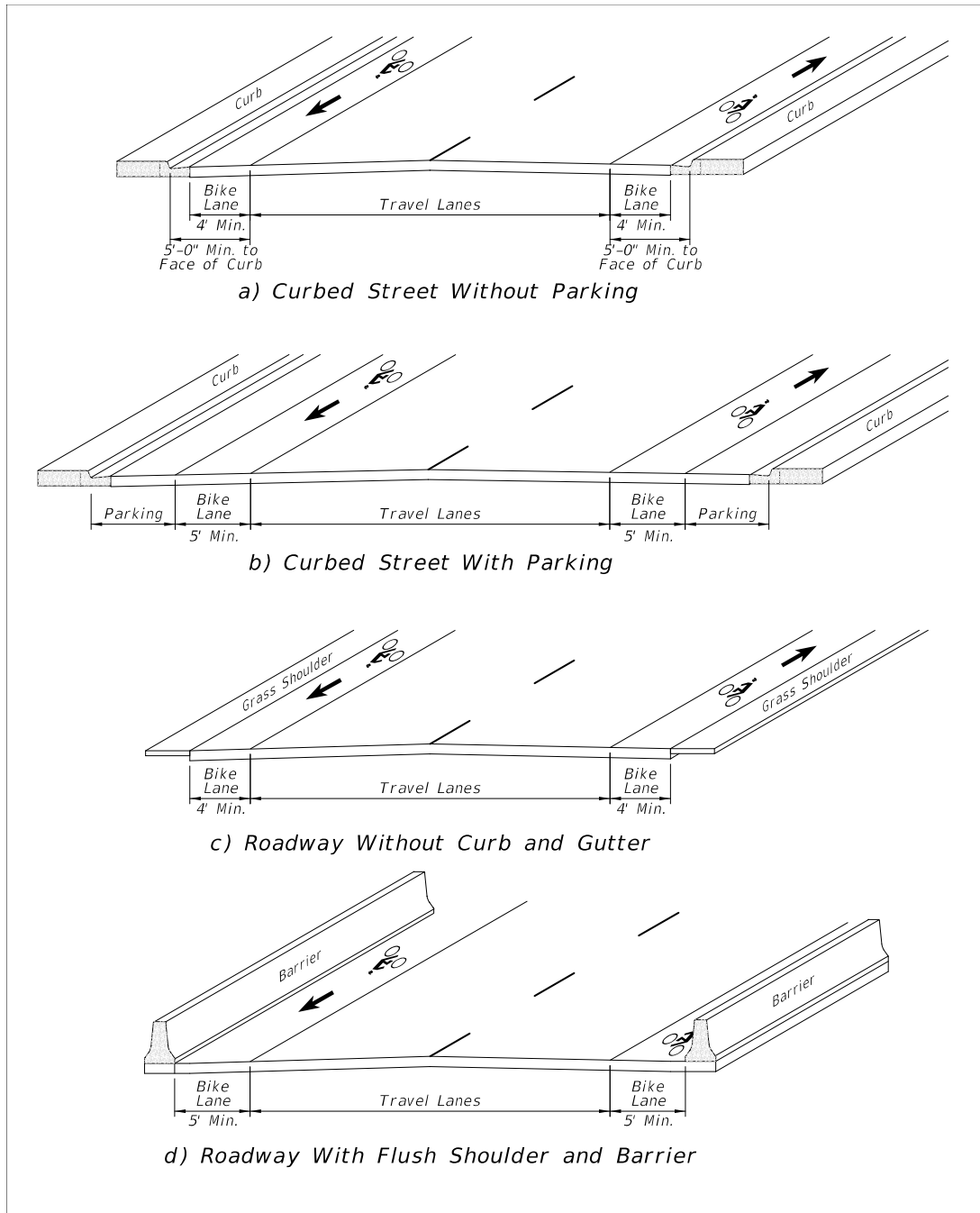

Bicycle lanes are one-way facilities and carry bicycle traffic in the same direction as the adjacent motor vehicle traffic. A bicycle lane should be delineated from the travel lanes with a solid white line and be marked with the bicycle symbol and arrow as shown in Figure 9 – 2 Detail of Bicycle Lane Markings. The dimensions for each pavement marking is 72" long, separated by 72".

The recommended placement of bicycle lane markings is:

- a) At the beginning of a bicycle lane, on the far side of major intersections, and prior to and within the bicycle lane between a through lane and turn lane.
- b) Along the roadway as needed to provide a maximum spacing of 1,320 for posted speeds less than or equal to 45 mph, 2,640 feet for a posted speed of 50 mph or greater.

**Figure 9 – 2 Detail of Bicycle Lane Markings**

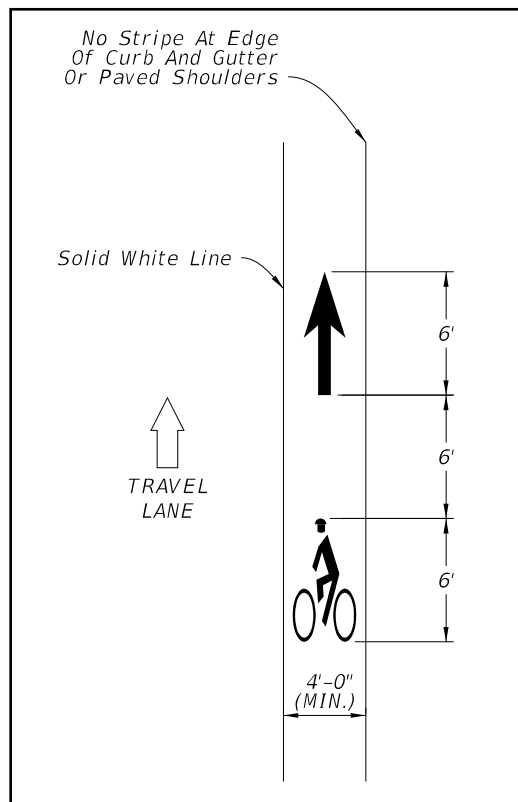

If used, bike lane signs and plaques should be placed in advance of the upstream end of the bicycle lane, at the downstream end of the bicycle lane, and at periodic intervals based upon prevailing speed of bicycle and other traffic, block length, and distances from adjacent intersections, and other considerations. They should only be used in conjunction with marked bicycle lanes. Bike lane signs are not required.

**Figure 9 – 3 Bicycle Lanes**



NACTO Urban Bikeway Design Guide, National Association of City Transportation Officials

A through bicycle lane shall not be positioned to the right of a right turn only lane or to the left of a left turn only lane. For new construction, reconstruction, and traffic operations projects, where bicycle lanes are provided between the through lane and right turn lane, bus bay or parking lane they shall be a minimum of 5 feet wide. For bicycle lanes adjacent to parking lanes, if the parking volume is substantial or the turnover is high a width of 6-7 feet is desirable to avoid opening vehicle doors.

On one-way streets, bicycle lanes should generally be placed on the right side of the street. A bicycle lane on the left side of the street can be considered when a bicycle lane on the left will substantially decrease the number of conflicts, such as those caused by frequent bus traffic, heavy right turning movements, high-turnover parking lanes, or if there are a significant number of left turning bicyclists. See Figure 9 – 4 Left Side Bicycle Lanes for an illustration.

**Figure 9 – 4 Left Side Bicycle Lanes**

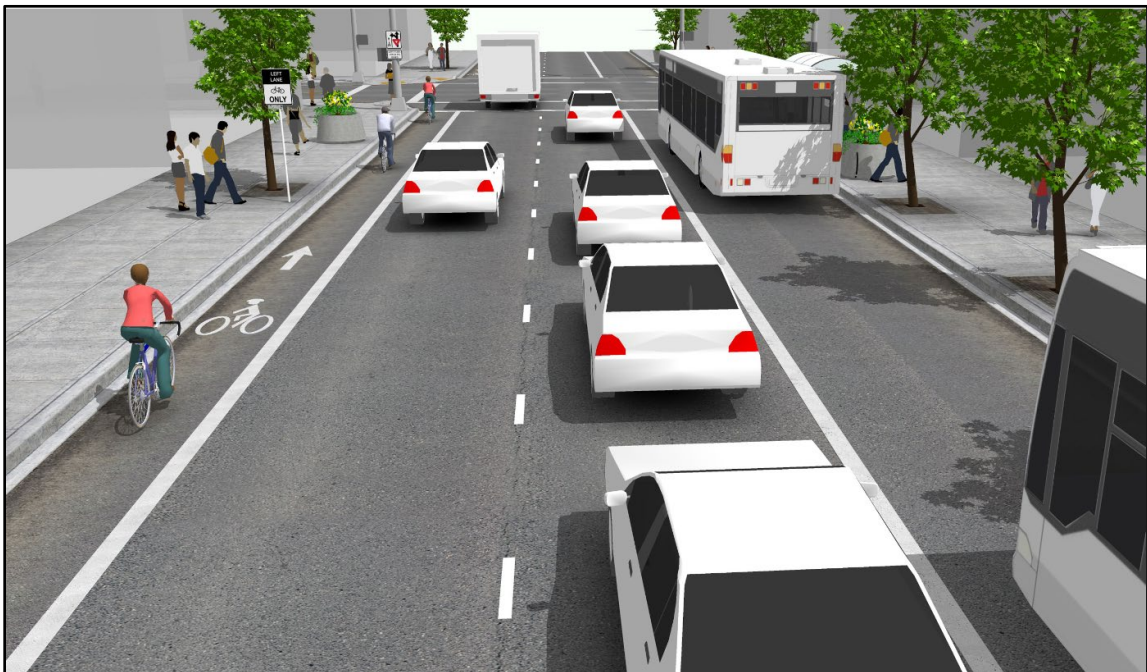

NACTO Urban Bikeway Design Guide, National Association of City Transportation Officials

Bicycle lanes shall not be provided on the circular roadway of a roundabout, and shall be transitioned prior to the roundabout in accordance with the MUTCD.

Existing drainage inlets, grates and utility covers shall be evaluated as to whether they present an obstruction to bicyclists, and should be relocated out of the cyclist's path of travel. Drainage inlets, grates and utility covers to remain should be adjusted to be flush with the adjacent pavement surface, utilize a grate recommended for bicycle travel, and may be marked as an obstruction.

Advance warning of an inlet or other obstruction may be provided as shown in the [MUTCD, Part 9](#). Additional information on appropriate drainage inlets in or near pedestrian and bicycle facilities can be found in [the FDOT's ~~the Department's~~ Florida Dept. of Transportation's Drainage Manual, Section 3.7.4 Inlet Placement, \(2022\) January 2018 Edition.](#)

**Figure 9 – 5 Example of Obstruction Pavement Markings**

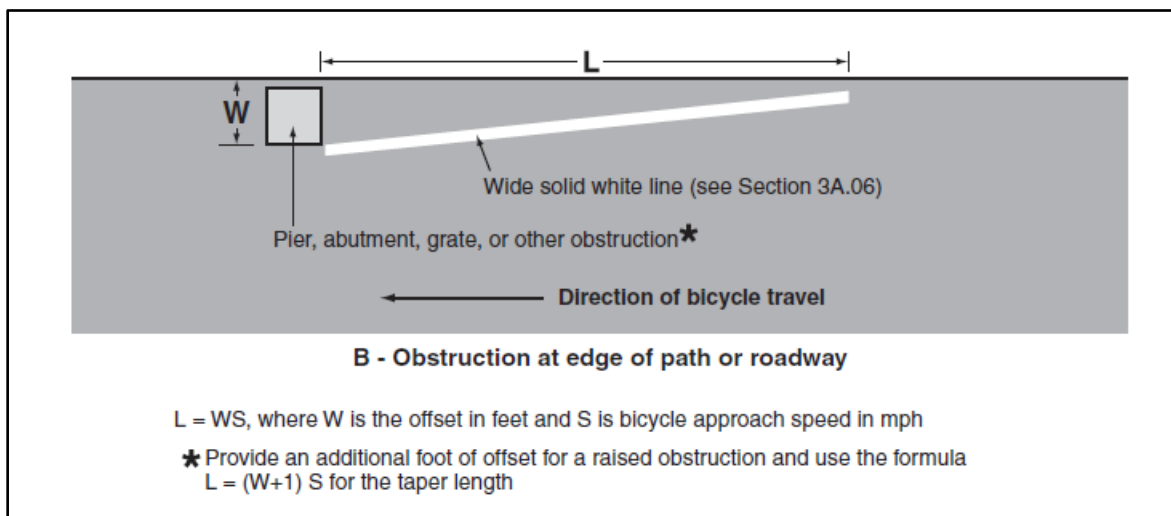

Traffic signals should be responsive to bicyclists. Regular maintenance of bicycle lanes should be a priority, since bicyclists are unable to use a lane with potholes, debris, or broken glass.

In conjunction with resurfacing projects, the roadway width shall be redistributed when practical to provide for bicycle facilities. The types of bicycle facilities considered for implementation include buffered bicycle lanes, bicycle lanes, wide outside lanes, and shared lanes. Lane widths on urban multilane roadways and two-lane curb and gutter roadways may be reduced as shown in Table 9 – 1 Lane Widths to provide for bicycle facilities.

**Table 9 – 1 Lane Widths Urban Multilane or  
Two-Lane with Curb and Gutter**

<b>Design Year AADT</b>	<b>Design Speed (mph)</b>	<b>Minimum Thru Lane (ft.)</b>	<b>Minimum Turn Lane (ft.)</b>	<b>Minimum Parking Lane (ft.)</b>
ALL	ALL	10 <sub>1</sub>	9 <sub>2</sub>	7 <sub>3</sub>

1. 11 ft. where either of the following conditions exist:
  - a) Trucks are >10% of Design Year Traffic.
  - b) Design Speed is 40 mph or greater.
2. 10 ft. for 2 Way Left Turn Lanes.
3. A minimum width of 7 ft. measured from face of curb may be left in place. Otherwise provide 8 ft. minimum, measured from face of curb.

Various configurations of bicycle lanes on curb and gutter and flush shoulder typical sections are illustrated in Figures 9 – 6 to 9 – 23.



**Figure 9 – 6 Bicycle Lane Markings**

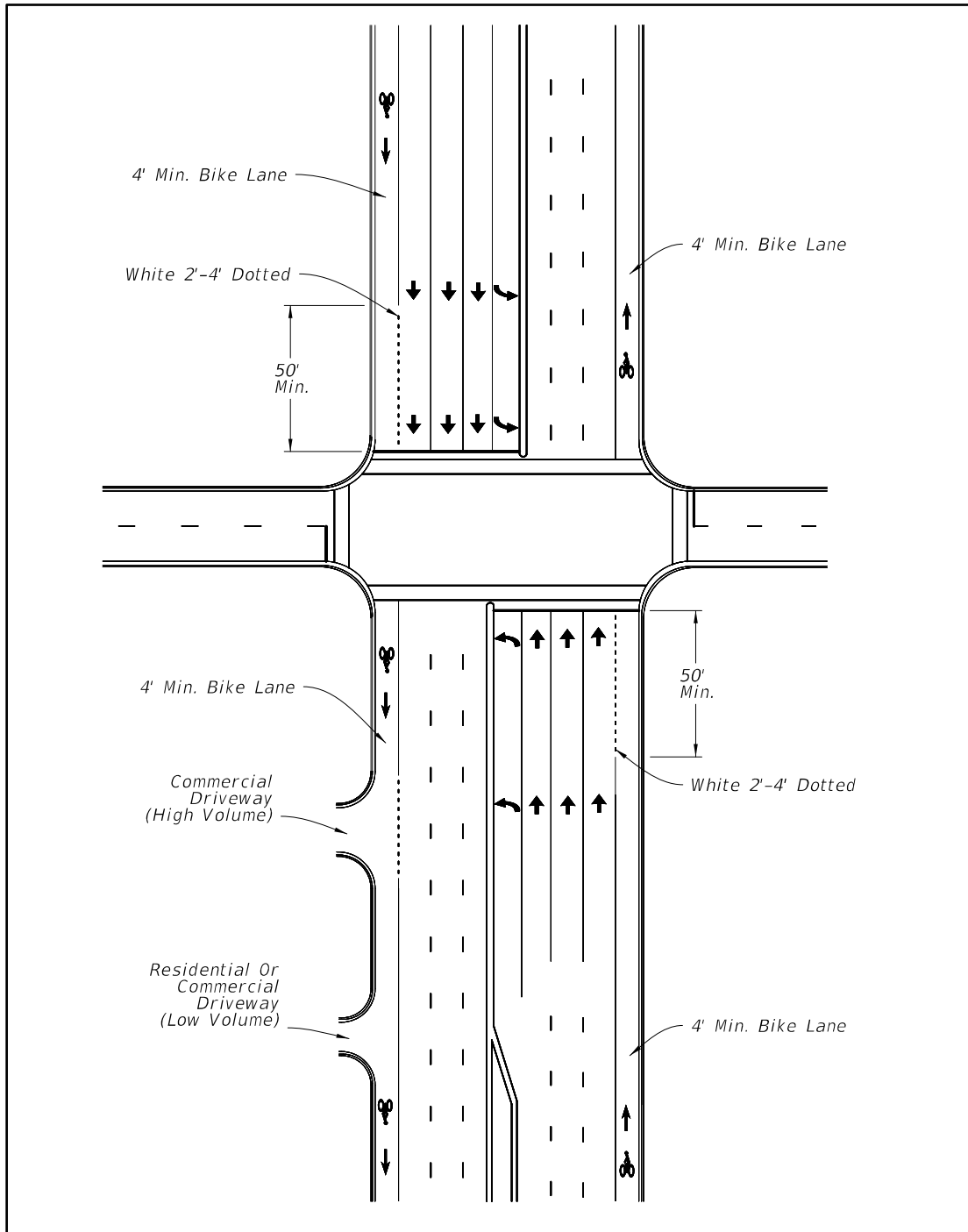

**Figure 9 – 7 Bicycle Lanes with Separate Right Turn Lane  
(Curb and Gutter)**

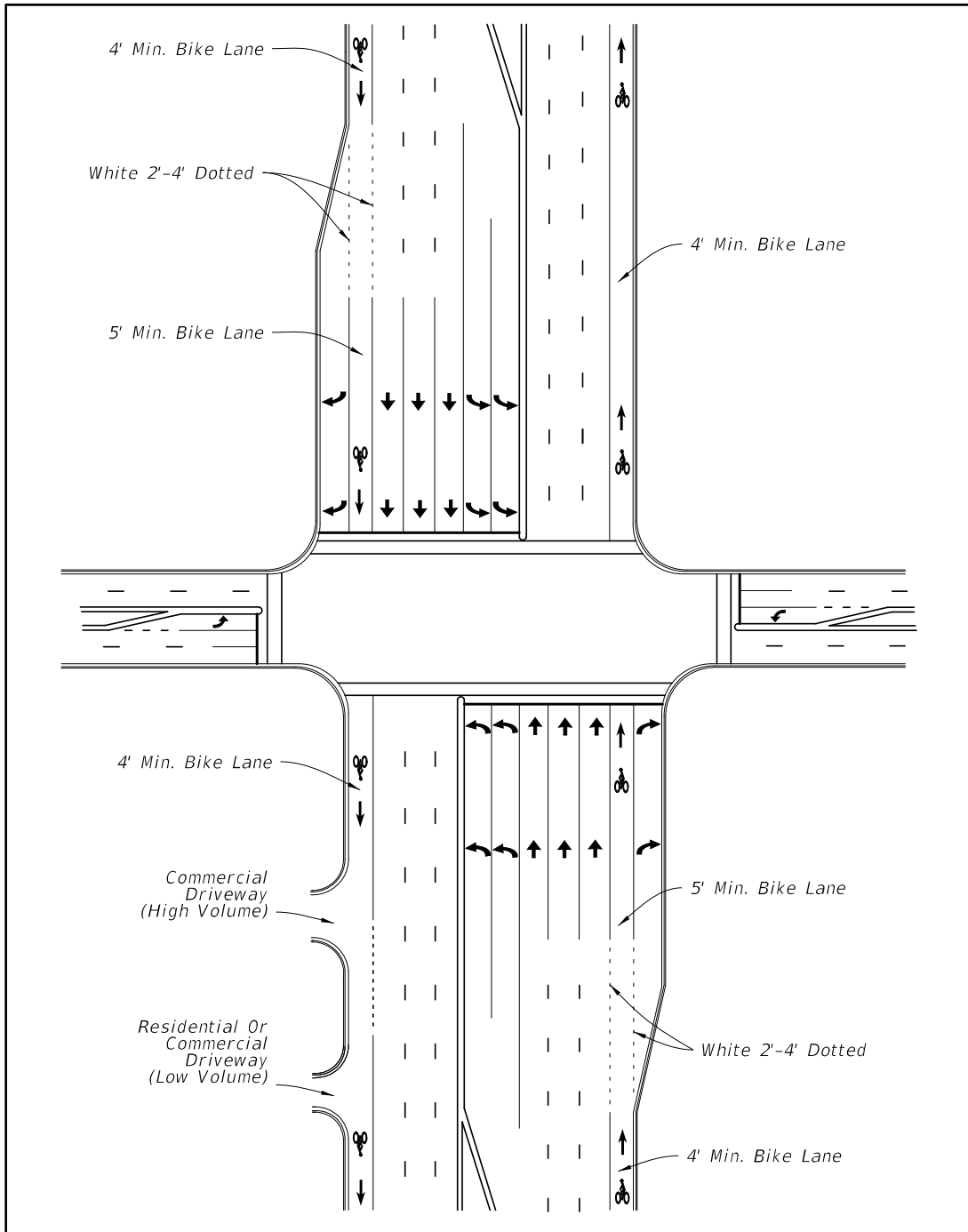

**Figure 9 – 8 Bicycle Lanes with On Street Parking, No Right Turn Lane  
(Curb and Gutter)**

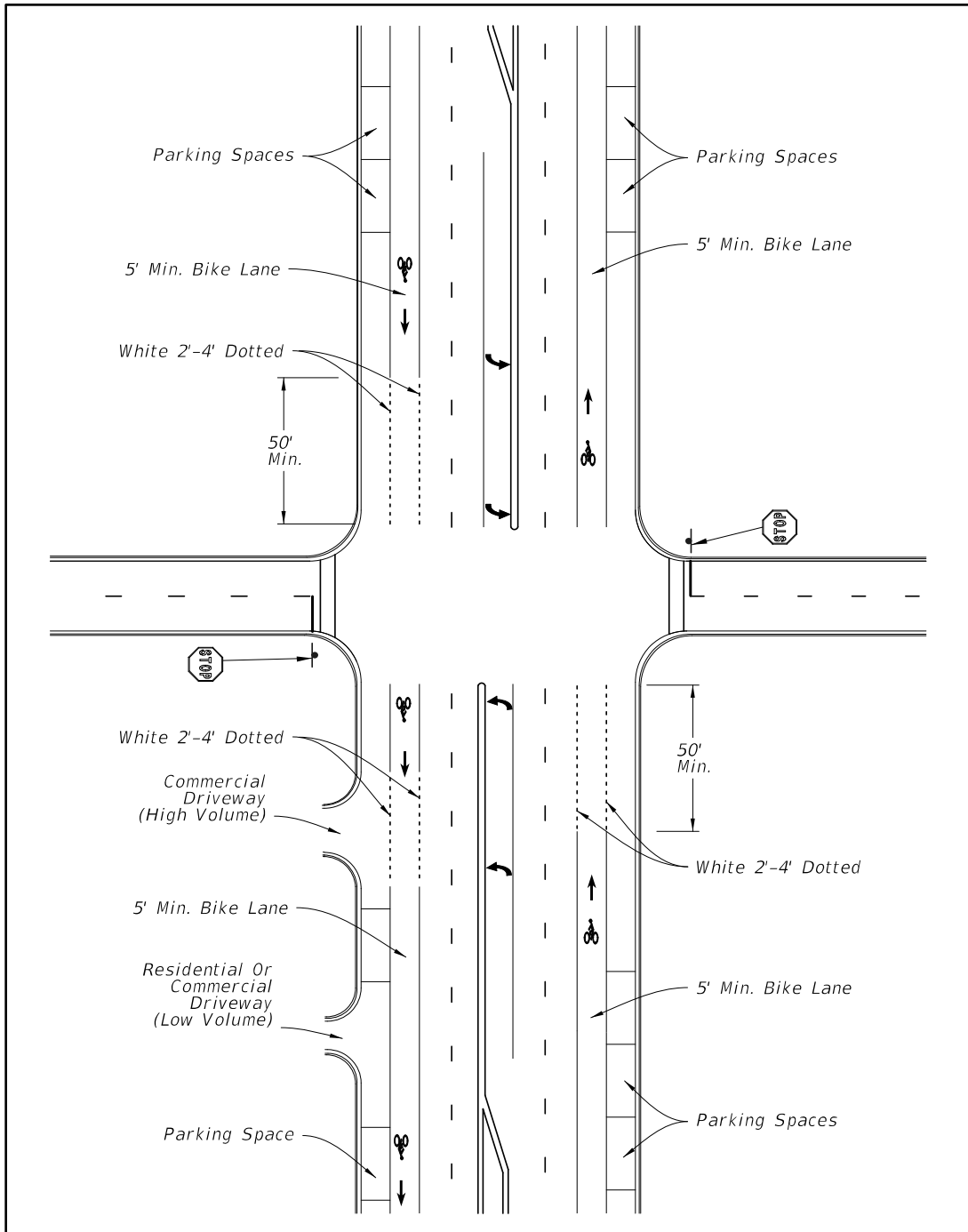

**Figure 9 – 9 Bicycle Lane with Right Turn Drop Lane  
(Curb and Gutter)**

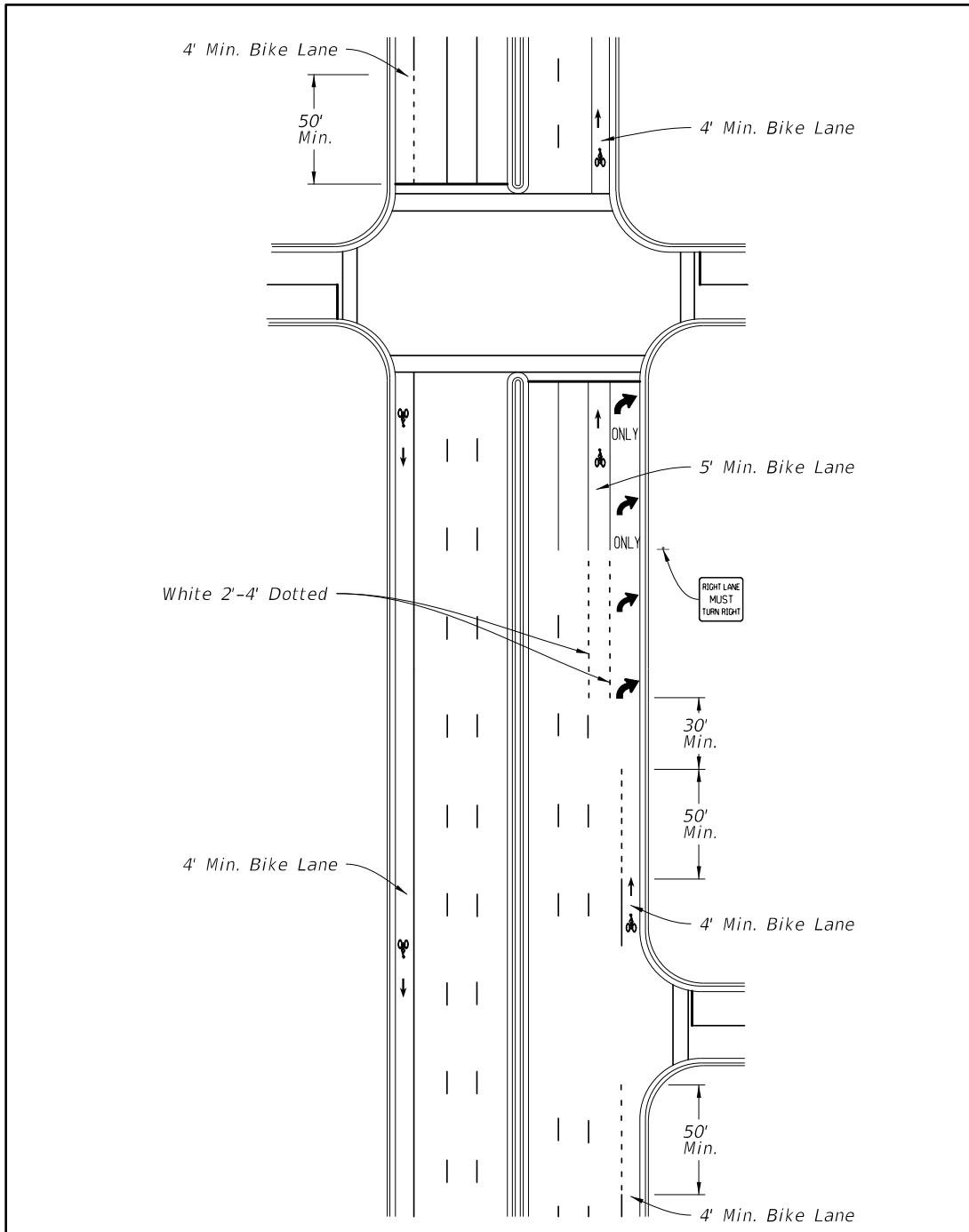

**Figure 9 – 10 "Tee" Intersection with Bicycle Lane, Separate Right and Left Turn Lanes (Curb and Gutter)**

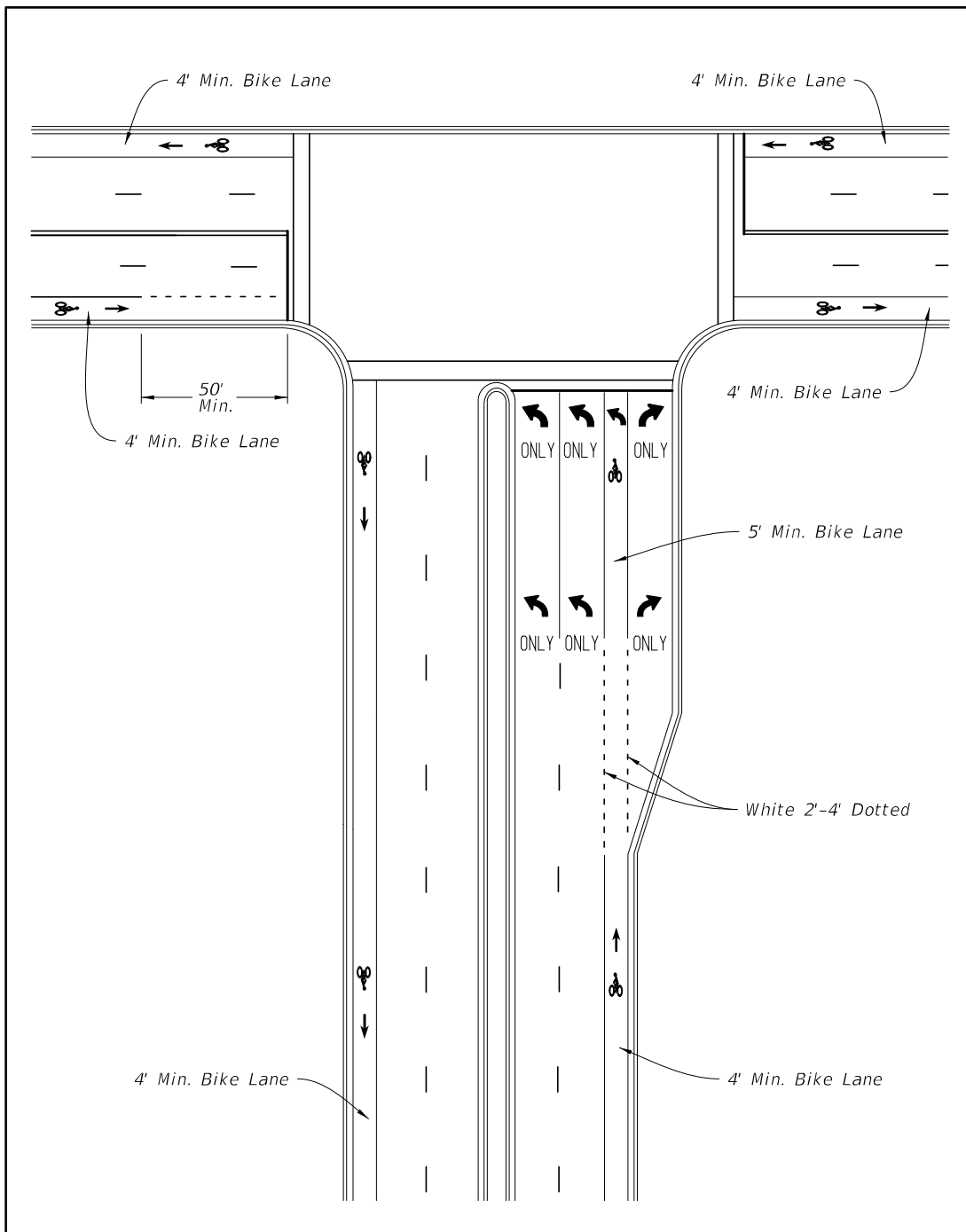

**Figure 9 – 11 "Tee" Intersection with Bicycle Lanes, Left Turn Lane and Right Turn Drop Lane (Curb and Gutter)**

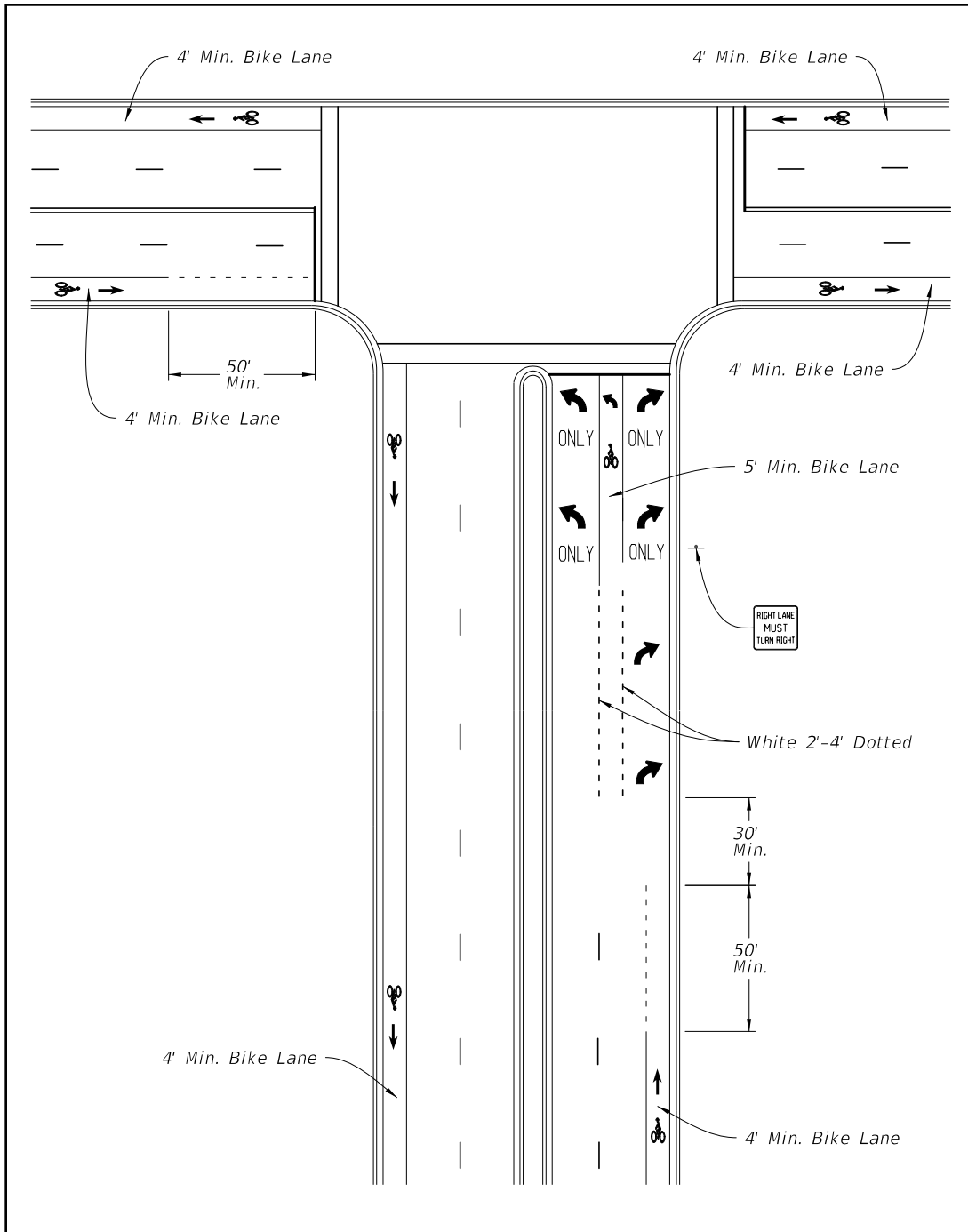

**Figure 9 – 12 Bicycle Lanes with No Right Turn Lane  
(Flush Shoulder)**

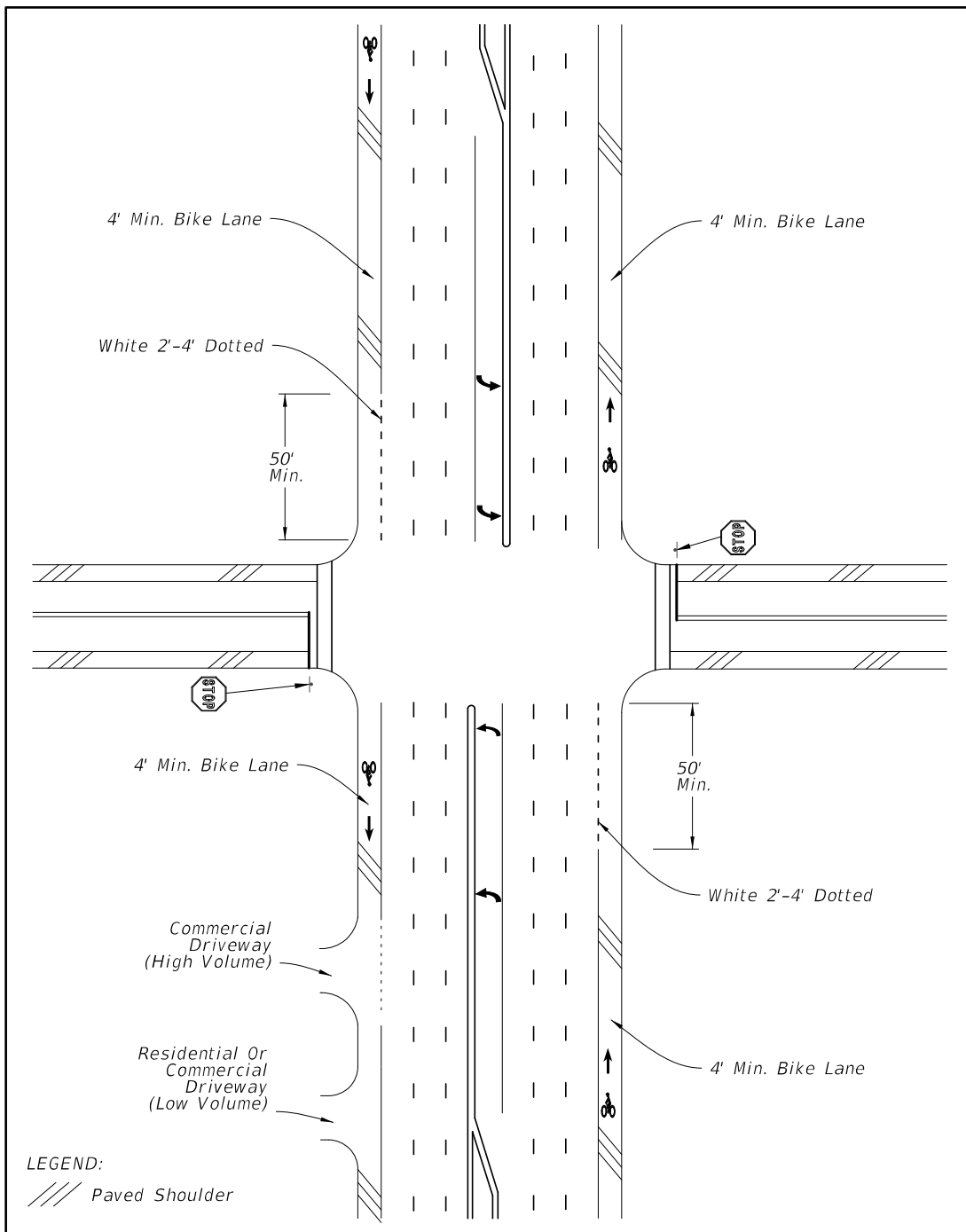

**Figure 9 – 13 Bicycle Lane with Separate Right Turn Lane  
(Flush Shoulder)**

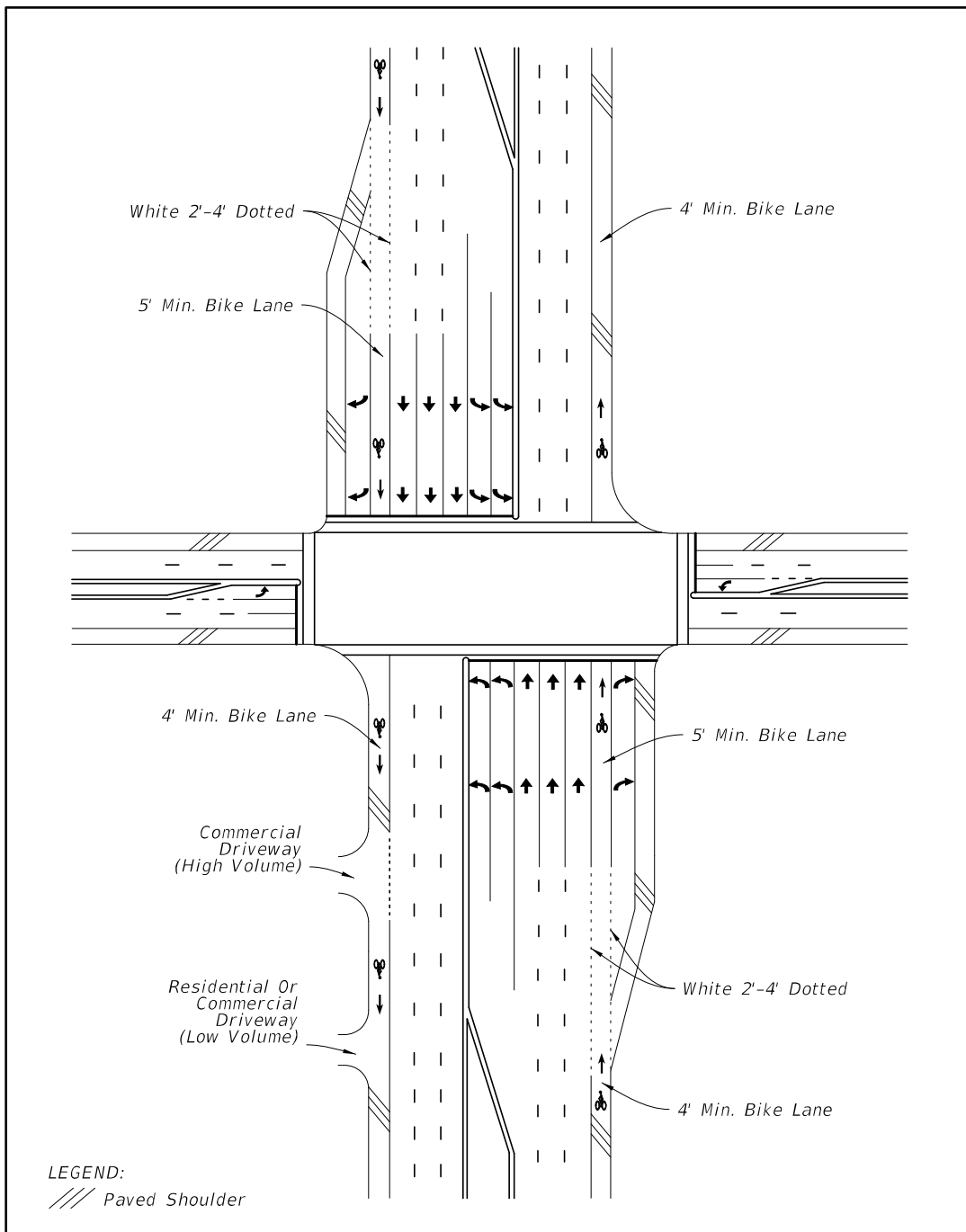





**Figure 9 – 15 Bicycle Lanes on Interchange Ramps  
(Flush Shoulder)**

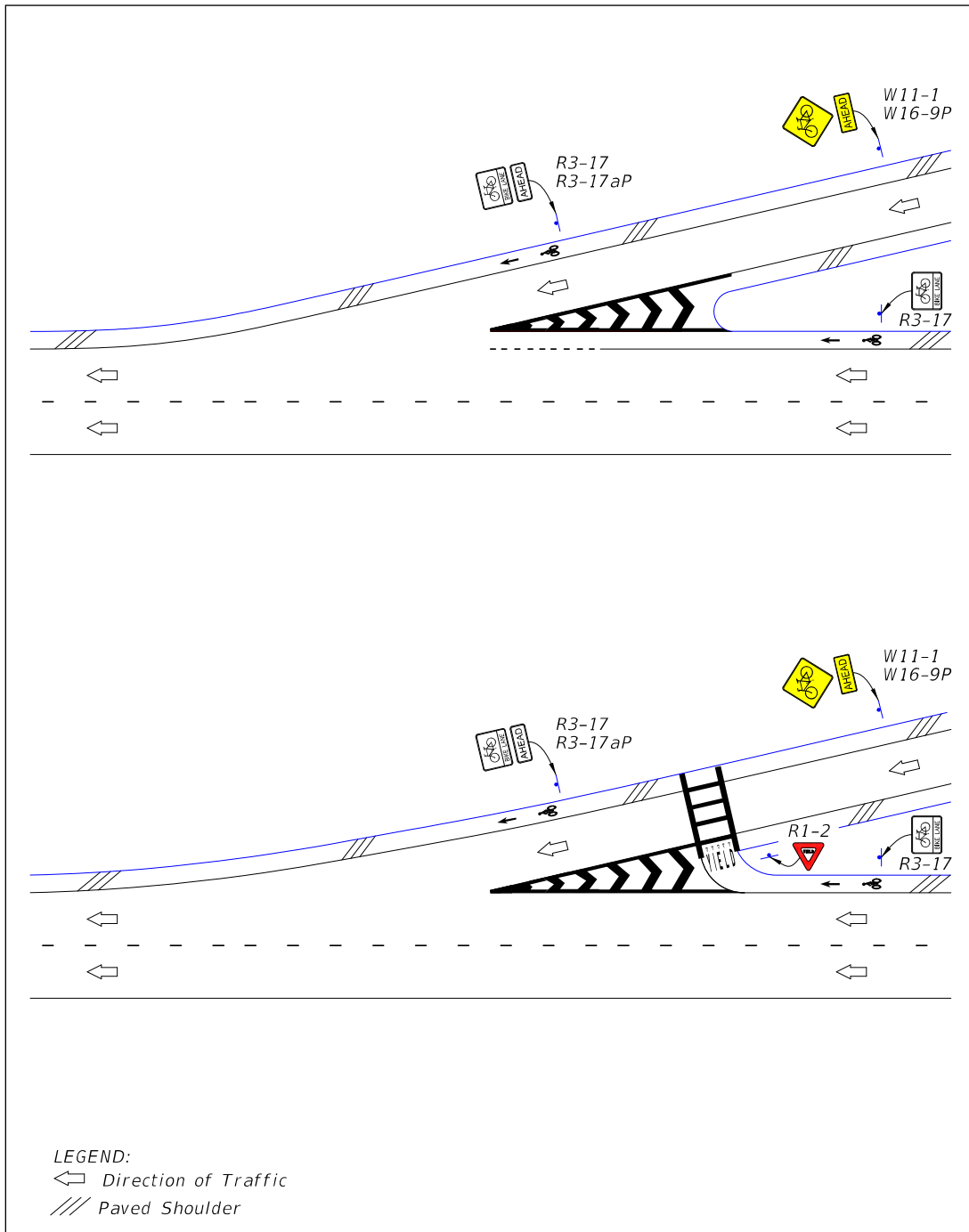

## B.2 Buffered Bicycle Lanes

Buffered bicycle lanes are bicycle lanes separated from either the adjacent travel lane or parking lane with a marked buffer area. They provide greater shy distance between motor vehicles and bicyclists and encourage bicyclists to ride outside of the “door zone” of parked cars. Typical applications include streets with high travel speeds, high traffic volumes, high amounts of truck or transit traffic, or where there are underutilized travel lanes or extra pavement width.

The bicycle lane symbol and arrow markings shall be used, along with longitudinal lines to create the buffer. There are several options for marking the buffer area, including a wide solid double line (crossing prohibited), wide solid single line (crossing discouraged) or wide dotted single line (crossing permitted to make right hand turn). Where the buffer space is wider than 4 feet and crossing the buffer is prohibited, chevron markings should be placed in the buffer area.

At an intersection approach, the buffer striping should transition to a wide dotted stripe using a 2/4 skip pattern. The transition should begin 150 feet in advance of an intersection to provide sufficient distance for an automobile or truck to merge into the bicycle lane before turning right. Figures 9 – 16, 17 and 18 provide examples of buffered bicycle lanes. [Chapter 3D. Markings for Preferential Lanes of the MUTCD](#) provides additional information on the striping of buffered bicycle lanes.

**Figure 9 – 16 Buffered Bicycle Lane Adjacent to On-Street Parking**

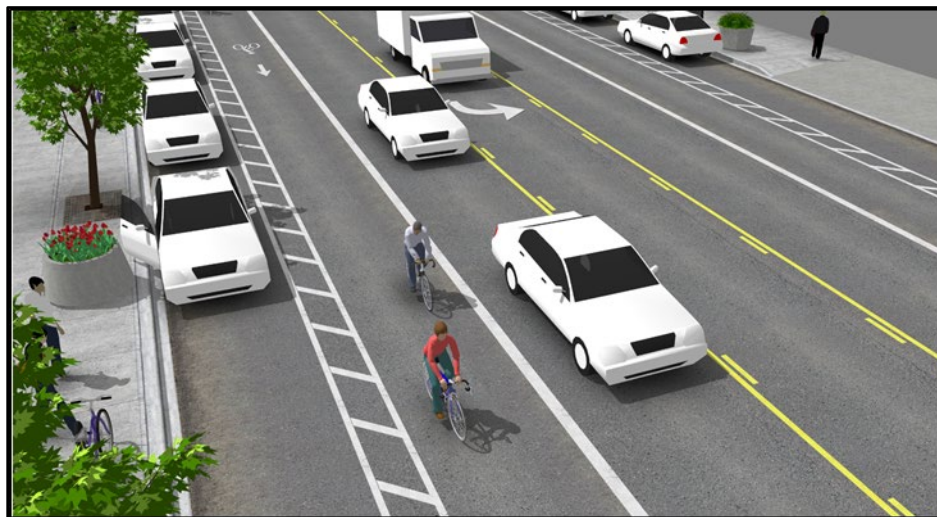

NACTO Urban Bikeway Design Guide, National Association of City Transportation Officials

**Figure 9 – 17 Buffered Bicycle Lane Markings**

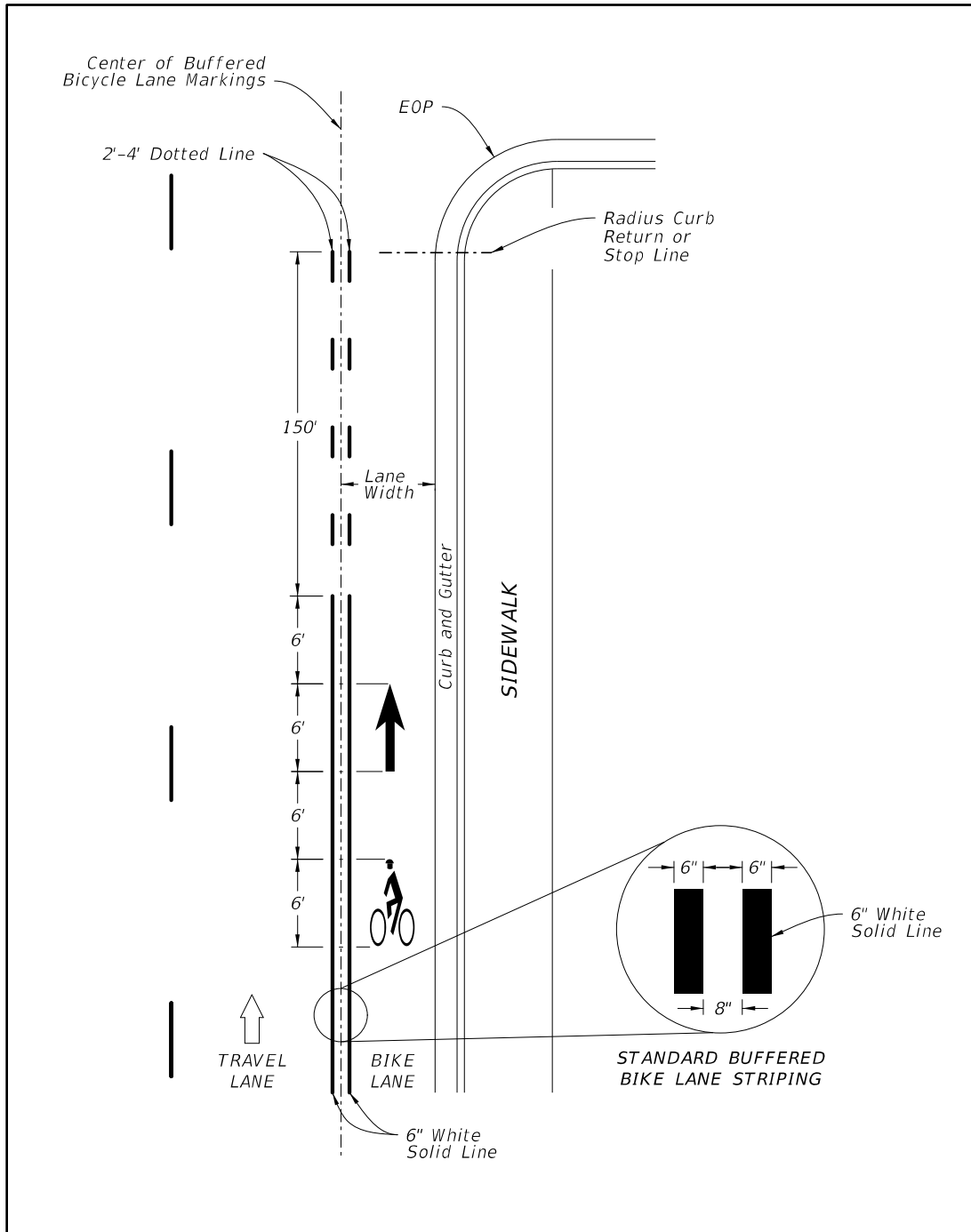

**Figure 9 – 18 Buffered Bicycle Lane Markings with On-Street Parking**

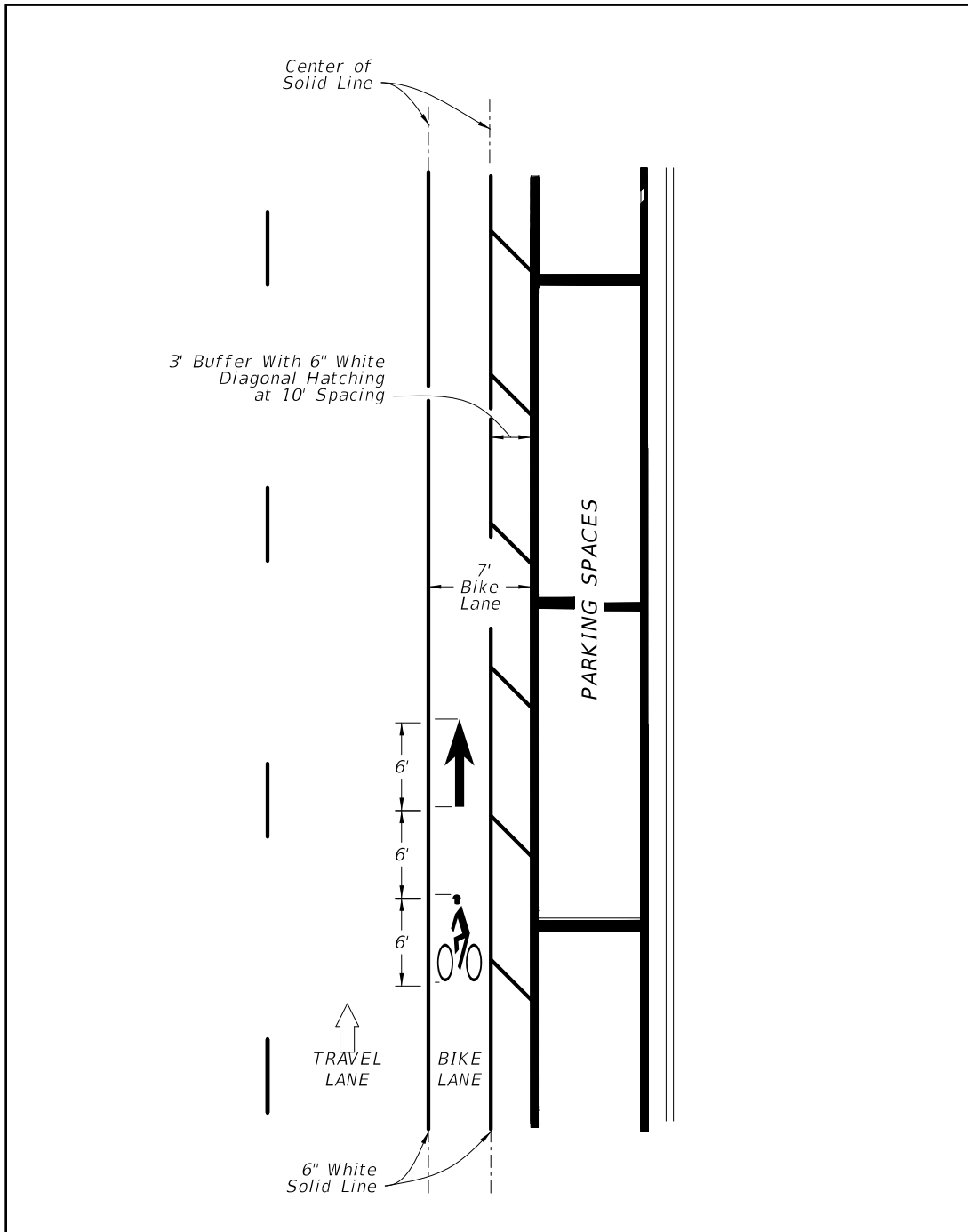

### B.3 Bicycle Lane with Bus Bay

When a bus bay is provided on roadways with bicycle lanes, the bicycle lane shall be continued adjacent to the bus bay. Figure 9 – 19 Buffered Bicycle Lane with Bus Bay Marking provides an example of a buffered bicycle lane with a bus bay.

**Figure 9 – 19 Buffered Bicycle Lane with Bus Bay Marking  
(Curb and Gutter)**

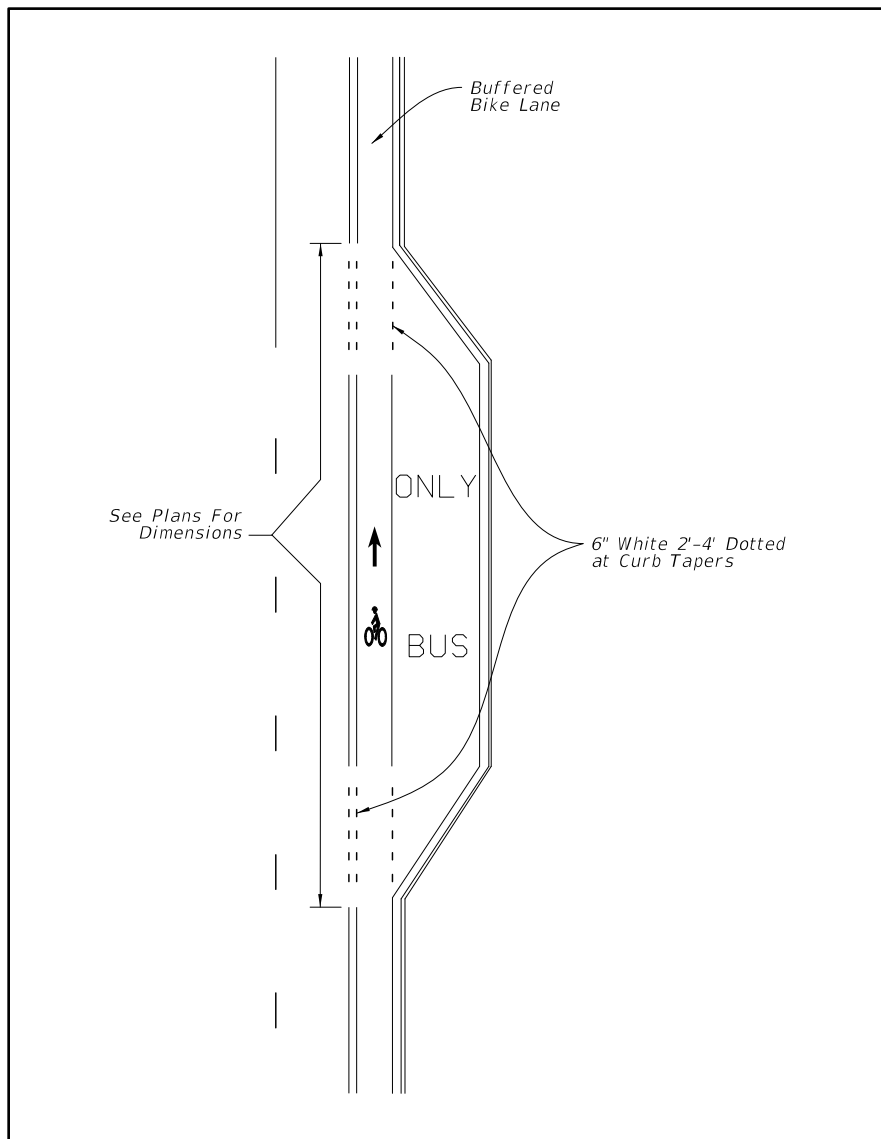

## **B.4 Separated Bicycle Lanes**

Separated bicycle lanes use a combination of horizontal separation (buffer distance) and vertical separation (e.g., flex posts, parked cars, medians, traffic separators, or curbs) to separate people bicycling from motor vehicle traffic. The combination of lateral separation distance and vertical separation elements (such as flexible delineators, curbs or height differences, or vehicle parking) can improve the comfort level of bicycling. They may be designed to support either one-way or two-way traffic. The amount of separation tends to increase as adjacent motor vehicle traffic volumes and speed increase.

Required features of a separated bicycle lane include:

- Is a preferential use lane, signed and marked as required by the **MUTCD**. Include the bicycle lane symbol and arrow markings at the beginning of the lane and at periodic intervals.
- A horizontal separation is required, vertical elements may be added when required or desired.
- Types of vertical elements include changes in elevation, tubular markers, or similar type of lane delineator, raised medians, traffic separators, on-street parking, and rigid barriers (with appropriate end treatments). For posted speeds of 40 to 45 mph, raised medians, traffic separators or rigid barriers are required.
- The widths of separation are:
  1. A minimum of 3 feet separation is required if adjacent to on-street parking.
  2. If adjacent to travel lanes:
    - Posted speeds of 35 mph or less – a 6 feet minimum separation is preferred, 3 feet minimum (unless using tubular markers or similar type of lane delineator or raised median; then 2 feet minimum).
    - Posted speeds of 40 to 45 mph – an 8 feet minimum separation is preferred, 3 feet minimum.
- For one-way separated bicycle lanes, 7 feet is the preferred width, 6 feet is the minimum allowed. For two-way separated bicycle lanes, 12 feet is the preferred width, 10 feet is the minimum allowed.
- Separation is maintained between bicycle and motorized vehicle traffic through intersections.
- Conflict points are minimal and mitigated through pavement markings, color or

other treatment.

For additional information on planning and designing separated bike lanes, please see [FHWA's Separated Bike Lane Planning and Design Guide](#).

## **B.54 Green Colored Bicycle Lanes**

The Federal Highway Administration (FHWA) has issued an [Interim Approval](#) for the use of green colored pavement in bicycle lanes and in extensions of bicycle lanes through intersections and other traffic conflict areas. Colored pavements shall not replace or be used in lieu of required markings for bike lanes as defined in the **MUTCD**, but shall only supplement such markings. Traffic conflict areas include where the:

- bicycle lane crosses a right turn lane,
- traffic in a right turn lane crosses a bike lane, or
- bicycle lane is adjacent to a dedicated bus bay.

The Interim Approval may be found at the following website and provides further information on how to submit a written request to use green colored pavement:

[http://mutcd.fhwa.dot.gov/res-interim\\_approvals.htm](http://mutcd.fhwa.dot.gov/res-interim_approvals.htm)

The effectiveness of green colored pavement ~~is may be~~ maximized if the treatment is used only where the path of bicyclists and other road users cross and yielding must occur. Because colored pavements are addressed in the 2009 MUTCD, they are ~~by definition~~ a traffic control device whose need should be demonstrated before they are used. A need for this treatment can be demonstrated by either of the following:

1. A history of 3 or more motor vehicle-bicycle crashes exists at or adjacent to the traffic conflict area over the most recent three-year period, or
2. A government agency has observed and documented conflicts (failure of the motor vehicle to yield to the bicyclist) between cyclists and motor vehicles at an average rate of two per peak hour. The documentation for conflicts shall include observations from a minimum of two separate data collection periods, conducted on different days in a one month period, and include at least one weekday and one weekend count period during peak bicycle travel times. Each period should be at least 2 hours in duration. Peak times vary by region and surrounding land use, but are typically:



- Weekday, 11:00 AM to 1:00 PM
- Weekday, 5:00 PM to 7:00 PM
- Saturday, 8:00 AM to 2:00 PM

When used in conjunction with white skip lines, such as when extending a bike lane across a right turn lane or access to a bus bay, the transverse colored marking shall match the 2'-4' white skip line pattern of the bike lane extension. The green colored pavement should begin as a solid pattern 50 feet in advance of the skip striping, match the 2' 4' skip through the conflict area, and then resume the solid color for 50' after the conflict area, unless such an extent is interrupted by a stop bar or an intersection curb radius. Details of each installation and associated pavement markings shall be shown in the plans. Figures 9 – 20, 21, 22 and 23 illustrate how the green portion of the bicycle lane may be marked.

Materials permitted to color the bike lane green shall be non-reflective and fall within the color parameters defined by FHWA in their interim approval. Materials which have been tested to meet these requirements can be found in the FDOT's [FDOT's Product Application and Tracking System \(PATH\)](#) which includes products on both the FDOT's [FDOT's Approved Product List \(APL\), Specification 523, Patterned Pavement](#) or the FDOT's [FDOT's Innovative Products List \(IPL\), Dev-714 Green-Colored Pavement Markings](#).

**Figure 9 – 20 Green Bicycle Lane with Separate Right Turn Lane**

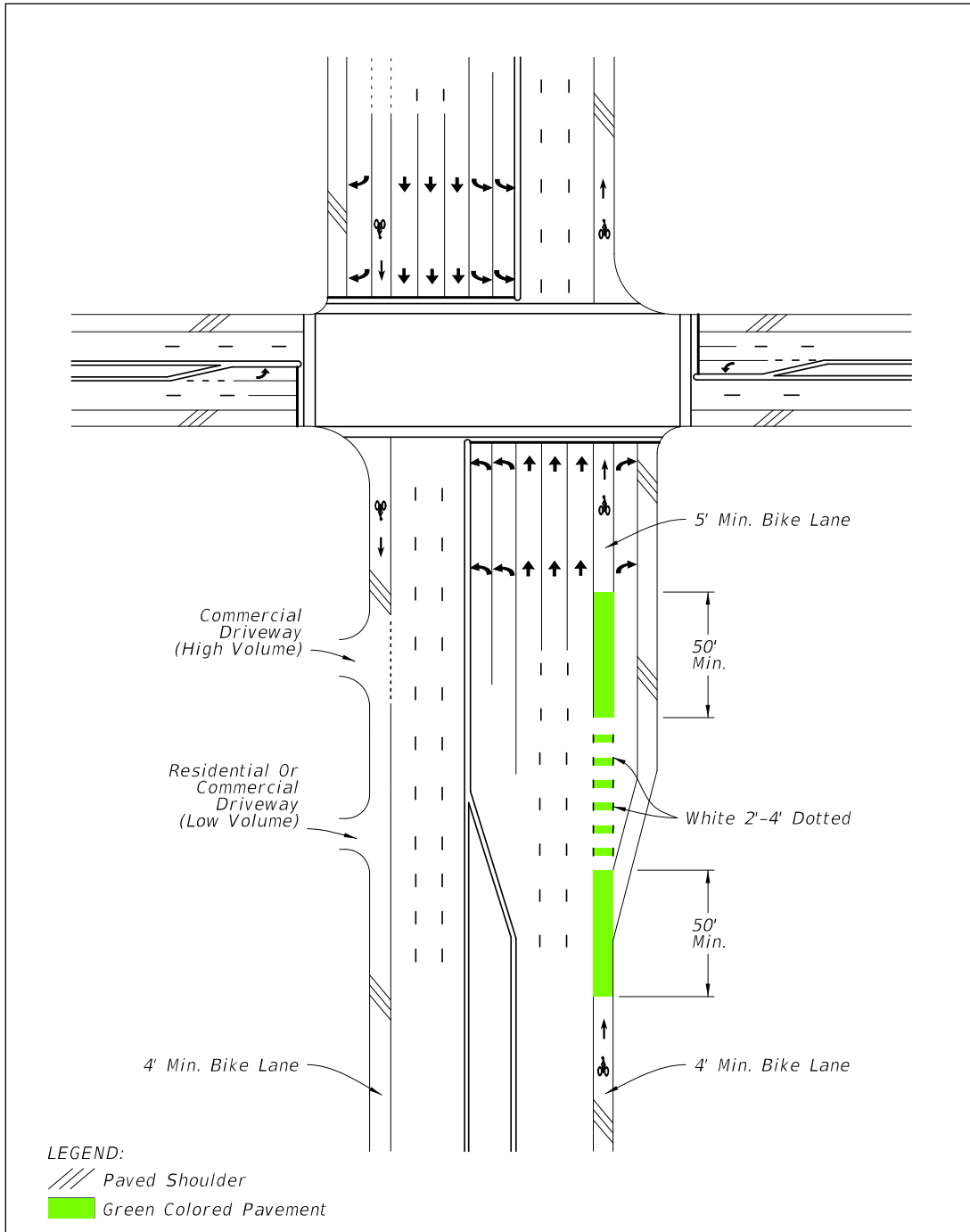

**Figure 9 – 21 Green Bicycle Lane with Right Turn Drop Lane**

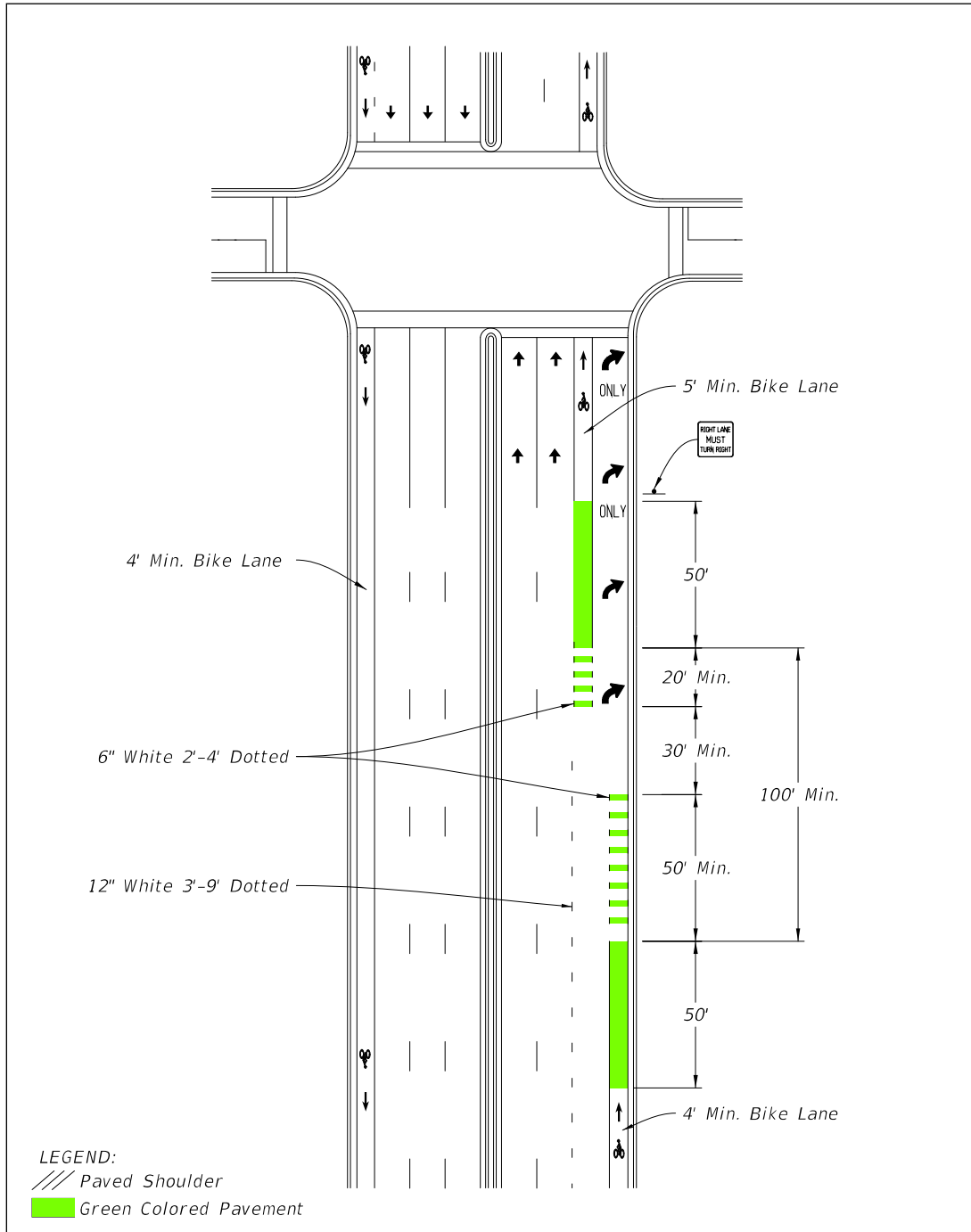

**Figure 9 – 22 Green Bicycle Lane with Channelized Right Turn Lane**

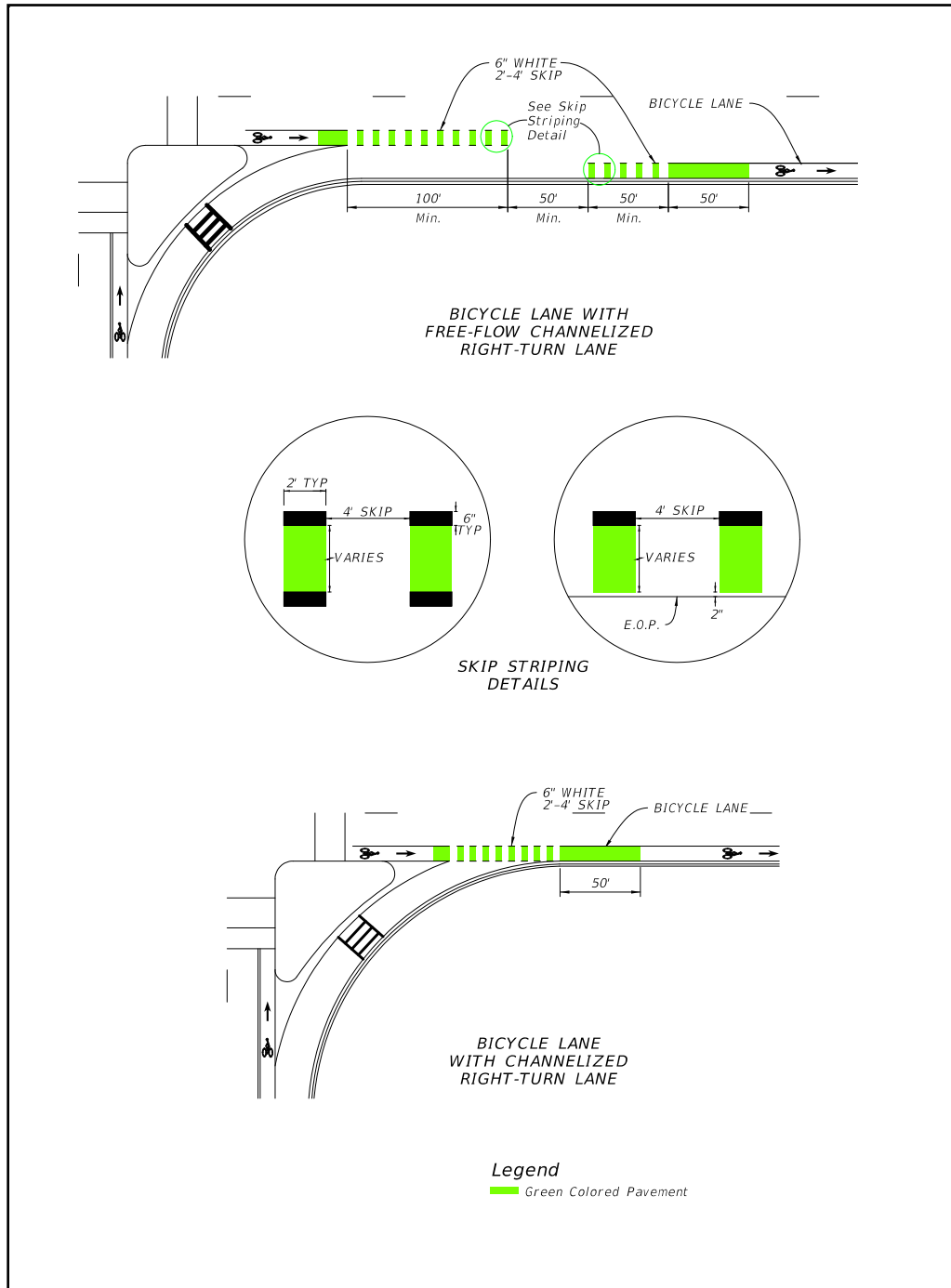
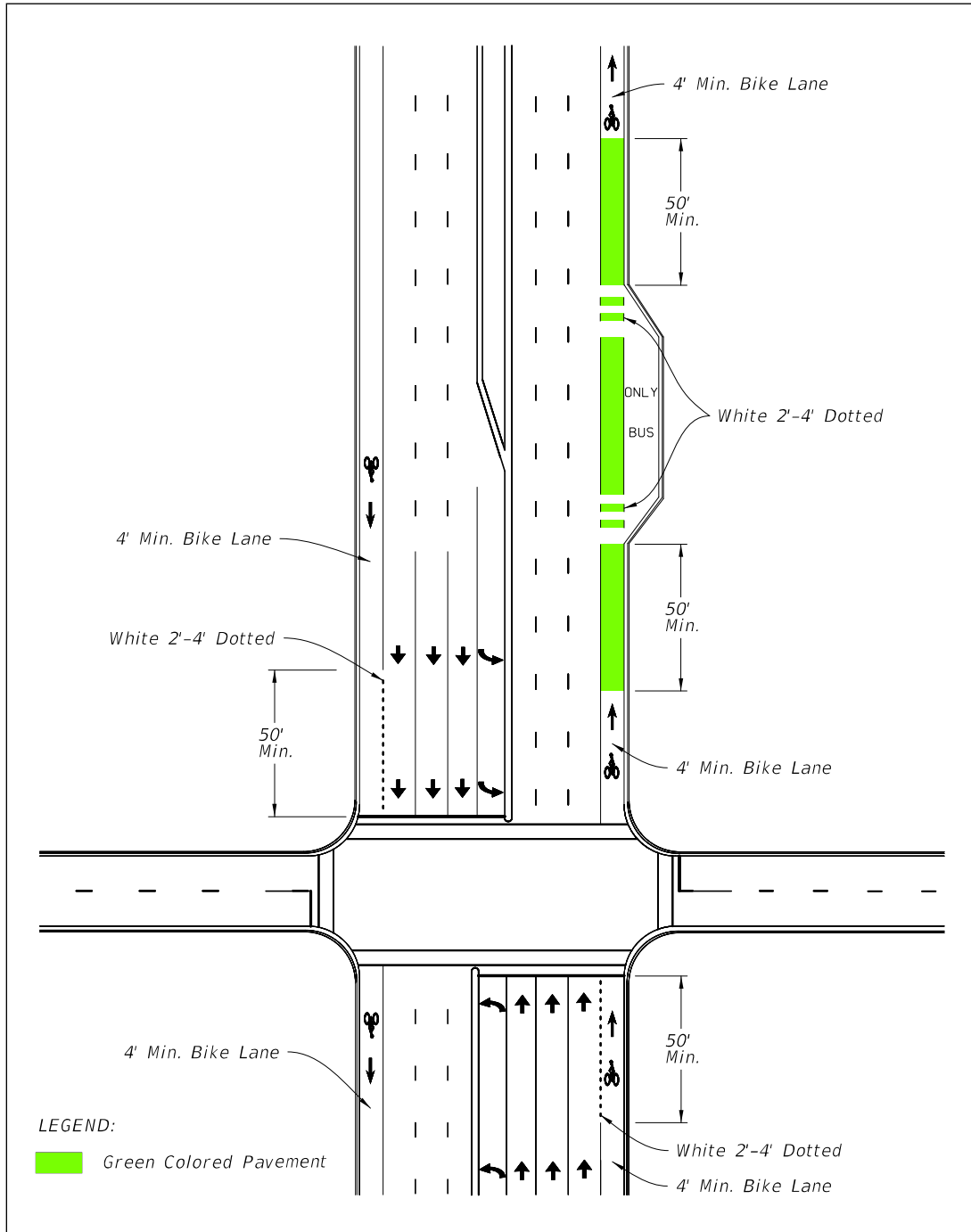

Figure 9 – 23 Green Bicycle Lane with Bus Bay



## **B.65 Paved Shoulders**

A paved shoulder is a portion of the roadway which has been delineated by edge line striping. Adding, widening or improving paved shoulders often can be an acceptable way to accommodate bicyclists. However, when a shoulder is intended to serve as a bicycle facility and is adjacent to a curb, guardrail or other roadside barrier, a minimum 5-foot clear width between the traveled way and the face of the barrier is required. Additional shoulder width is desirable if the posted speed exceed 50 mph, or the percentage of trucks, buses, or recreational vehicles is high (>10%).

Ground-in rumble strips should not be included in paved shoulders if a minimum clear width of 4 feet outside of the rumble strip cannot be provided.

## **B.76 Wide Outside Lanes**

Wide outside lanes on curbed roadways are through lanes that provide a minimum of 14 feet in width, which allows most motor vehicles to pass cyclists safely within the travel lane. Bicycle lanes are preferred for arterial and collector roadways, however, in some conditions, such as resurfacing projects, wide outside lanes may be the only practical option for a bicycle facility.

## B.87 Shared Lane Markings

The shared lane marking is an optional pavement marking for roadways where bicyclists and motor vehicles are intended to share the lane and no bicycle lane or paved shoulder exists or is feasible. Shared lane markings should be limited to roadways with a posted speed of 35 mph or less. They are not intended to be placed on every roadway without bicycle facilities or on shared use paths.

Shared lane markings provide guidance to cyclists on their lateral positioning, especially on roadways with on-street parking or lanes that are too narrow to share side by side with a motor vehicle. They also help to discourage wrong way riding and encourage safer passing of bicyclists by motorists. Shared lane markings may be used to identify an alternate route as part of an approved temporary traffic control plan. Figure 9 – 24 provides the dimensions for shared lane markings.

Shared lane markings should be placed as follows:

**Figure 9 – 24 Shared Lane Marking**

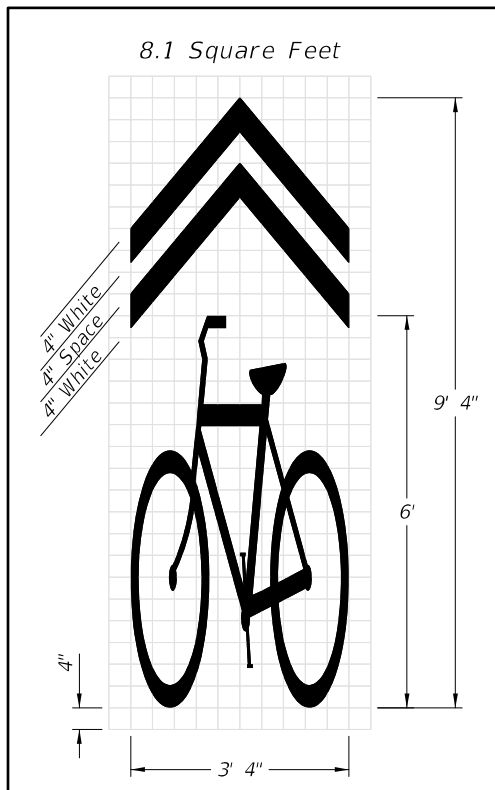

- If used on a roadway without on-street parking that has an outside travel lane that is 14 feet wide or less, the Shared Lane Markings should be centered in the travel lane (Figure 9 – 25).
- If used on a roadway with on-street parking, the Shared Lane Markings should be centered in the travel lane (Figure 9 – 26).
- Shared Lane Markings should be placed immediately after an intersection and spaced at intervals not greater than 250 feet thereafter.

**Figure 9 – 25 Shared Lane Marking Placement  
(No Designated Parking, Lane Width  $\leq$  14 Feet)**

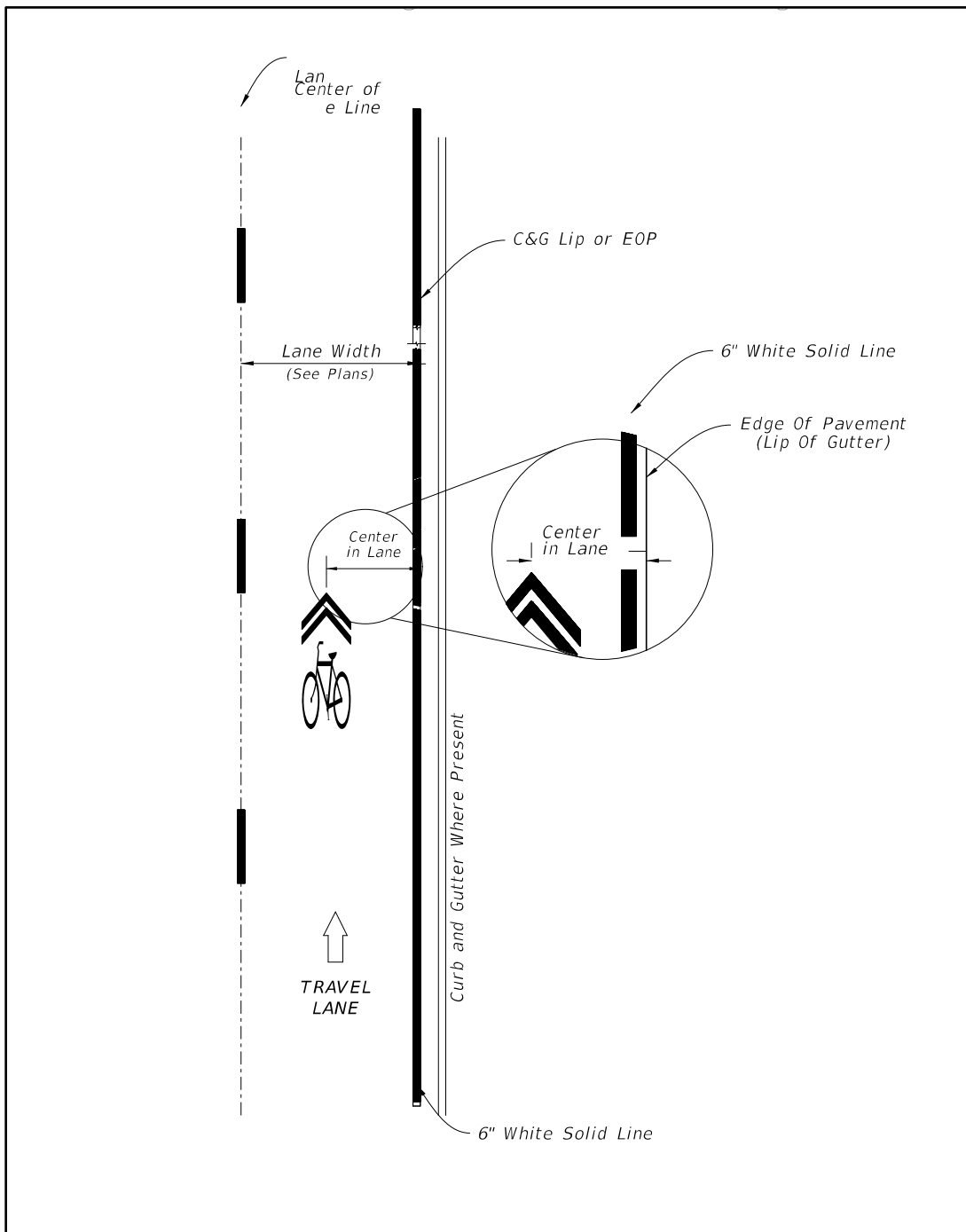



**Figure 9 – 26 Shared Lane Marking Placement  
(With On-Street Parking)**

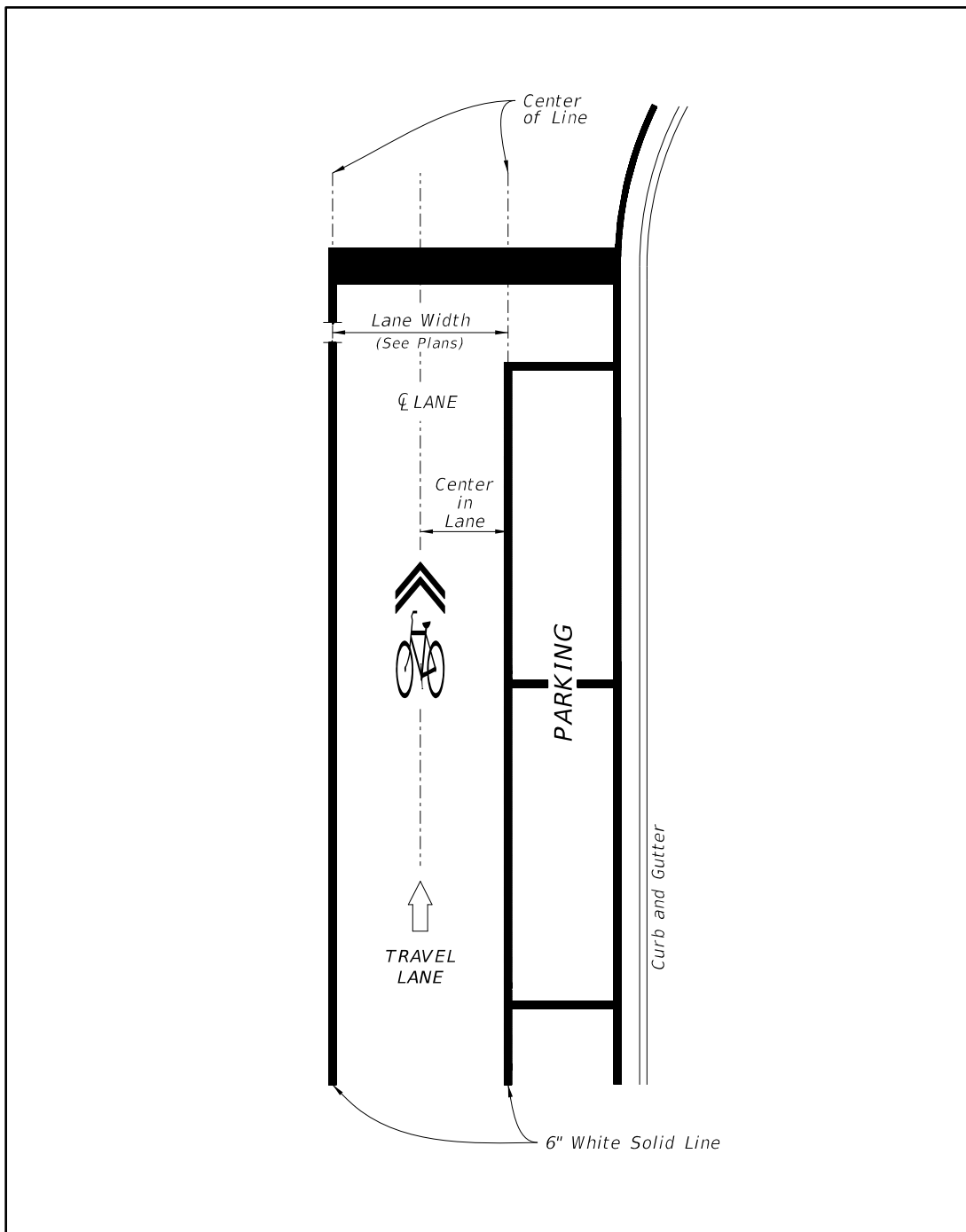

## **B.98 Bicycles May Use Full Lane Sign**

The Bicycle May Use Full Lane sign (R4-11) may be used on roadways where no bicycle lanes or adjacent shoulders useable by bicyclists are present and where travel lanes are less than 14' wide. The **MUTCD** provides additional information on the use of the sign.

## C SHARED USE PATHS

Shared use paths are paved facilities physically separated from motorized vehicular traffic by an open space or barrier and either within the highway right of way or an independent right of way, with minimal cross flow by motor vehicles. They are used by bicyclists, pedestrians, runners, skaters, and in some cases equestrians. The bicycle's operating characteristics will govern the design of shared use paths, along with requirements for accessibility since they also serve as pedestrian facilities.

In addition to the design criteria provided in this manual, the following documents provide criteria and guidance in the design of shared use paths:

- United States Department of Transportation ADA Standards for Transportation Facilities (2006) and as required by 49 C.F.R 37.41 or 37.43.
- United States Department of Justice ADA Standards (2010) as required by 28 C.F.R 35 (title II) and 36 (title III).
- Public Rights-of-Way Accessibility Guidelines (PROWAG) provides additional information for the design of pedestrian facilities.

The 2020 Florida Building Code, Accessibility, 7th Edition as required by 61G20-4.002 contains ADA requirements for accessibility to sites, facilities, buildings, and elements by people with disabilities.

~~The 2006 Americans with Disabilities Act—Standards for Transportation Facilities and the 2020 Florida Building Code, Accessibility Code (7<sup>th</sup> Edition) impose additional requirements for the design and construction of shared use paths since they serve as pedestrian facilities.~~

Shared use paths serve a variety of purposes. They can provide a school age child, a recreational cyclist, or a person with a disability an alternative to busy roadways. Shared use paths can be located along former rail corridors, the banks of rivers or canals, and through parks and forests. Shared use paths can also provide access to areas otherwise served only by limited access highways. For transportation purposes, they should be thought of as an extension of the roadway network for non-motorized users. The inclusion of a shared use path should not be considered as an alternative to providing on-street facilities, but, rather, as a supplement.

For additional information on shared use path design, refer to the [\*AASHTO Guide for the Development of Bicycle Facilities \(2012, 4th Edition\)\*](#).

## C.1 Width and Clearance

The useable width and horizontal clearance for a shared use path are primary design considerations. The minimum paved width for a two-way path is 10 feet. Typically, widths range from 10 to 14 feet, with the wider values applicable to areas with high use or a wider variety of users, on steep grades, through curves, or used by larger maintenance vehicles.

In very rare circumstances, a reduced width of 8 feet may be used where the following conditions prevail:

- Bicycle traffic is expected to be low, even on peak days or during peak hours.
- Pedestrian use of the facility is not expected to be more than occasional.
- Horizontal and vertical alignments provide frequent, well-designed passing and resting opportunities.
- The path will not be regularly subjected to maintenance vehicle loading conditions that would cause pavement edge damage.

In addition, a path width of 8 feet may be used for a short distance due to a physical constraint such as an environmental feature, bridge abutment, utility structure, or fence.

A minimum 2 foot wide graded, [clear](#) area with a maximum 1:6 slope shall ~~be~~ be maintained adjacent to both sides of the path; however, 3 feet or more is desirable to provide clearance from trees, poles, walls, fences, guardrails, or other lateral obstructions. See Chapter 8, Section D Barrier Separation and Chapter 4 – [Roadside Design](#), Figure 4 – 8 Location of Guardrail for information on when and how longitudinal barriers should be utilized,

Where the path is adjacent to canals, ditches, or slopes steeper than 1:3, a wider separation should be considered. A minimum 5 foot separation from the edge of the path pavement to the top of the slope is desirable. Depending on the height of embankment and condition at the bottom, a physical barrier, such as a railing or chain link fence may need to be provided.

Where ~~the a clear~~~~recovery~~ area adjacent to the shared use path is less than 5 feet wide, physical barriers or rails are recommended in the following situations:

- Slopes 1:3 or steeper, with a drop of 6 feet or greater.
- Slopes 1:3 or steeper, adjacent to a parallel body of water or other substantial obstacle
- Slopes 1:2 or steeper, with a drop of 4 feet or greater; and
- Slopes 1:1 or steeper, with a drop of 1 foot or greater.

The [AASHTO Guide for the Development of Bicycle Facilities \(2012, 4th Edition\)](#) provides additional information on the design of barriers or railings.

The desirable vertical clearance to obstructions is 10 feet. Fixed objects should not be permitted to protrude within the vertical or horizontal clearance of a shared use path. The recommended minimum vertical clearance that can be used in constrained areas is 8 feet. In some situations, vertical clearance greater than 10 feet may be needed to permit passage of maintenance and emergency vehicles.

## C.2 Separation Between Shared Use Paths and Roadways

When shared use paths are located adjacent to a roadway, a separation shall be provided. This demonstrates to both path users and motorists that the shared use path is a separate facility.

The minimum distance between a path and ~~roadway~~ ~~the face of curb or edge of traveled way (where there is no curb)~~ shall ~~be~~ be 5 feet. On roadways with curb, the distance is measured from the face of curb to the nearest edge of the path. On roadways with flush shoulders, this separation is measured from the:

- Paved shoulder - outside edge of the paved shoulder to the inside edge of the path
- Unpaved shoulders - outside edge of the traveled way to the inside edge of the path
- Where the separation is less than 5 feet, a physical barrier or railing should be provided between the path and the roadway.

A barrier or railing between the path and adjacent highway should not impair sight distance at intersections, and should be designed to limit the potential for injury to

errant motorists or bicyclists. The barrier or railing need not be of size and strength to redirect errant motorists toward the roadway, unless other conditions indicate the need for a crashworthy barrier.

Barriers or railings at the outside of a structure or steep fill embankment that not only define the edge of the path but also prevent bicyclists from falling over the rail to a substantially lower elevation should be a minimum of 42" high. Barriers at other locations that serve only to separate the area for motor vehicles from the path should generally have a minimum height equivalent to the height of a standard guard rail.

When a path is placed along a high-speed highway, a separation greater than 5 feet is desirable.

### **C.3 Design Speed**

For paths in relatively flat areas (grades less than or equal to 4%), a design speed of 18 mph shall be used. When a sustained downgrade greater than 4% exists, refer to the [\*AASHTO Guide for the Development of Bicycle Facilities \(2012, 4th Edition\)\*](#) for further guidance,

### **C.4 Horizontal Alignment**

The typical adult bicyclist is the design user for horizontal alignment. Please refer to the *AASHTO Guide for the Development of Bicycle Facilities (2012, 4th Edition)* for further information on determining the minimum radius of curves on shared use paths.

Shared use paths should be transitioned as necessary towards the roadway at intersections to provide a more functional crossing location that also meets driver expectation.

### **C.5 Accessibility**

Since nearly all shared use paths are intended to be used by pedestrians, they fall under the accessibility requirements of the Americans with Disabilities Act.

Where a shared use path is contained within a street or highway right of way, the grade of the shared use path shall not exceed the general grade established for the adjacent street or highway. Where a shared use path is not contained within a street or highway right of way, the grade of the shared use path shall be 5 percent

maximum.

Where compliance with the maximum grade requirements for shared use paths is not practicable due to existing terrain or infrastructure, right-of-way availability, a notable natural feature, or similar existing physical constraints, compliance is required to the extent practicable.

The cross slope of a shared use path shall be 2% maximum.

Pull boxes, manholes (and other utility covers), and other types of existing surface features in the location of a proposed curb ramp or detectable warning should be relocated when feasible. When relocation is not feasible, the feature shall be adjusted to meet the ADA requirements for surfaces (including the provision of a nonslip top surface, and adjustment to be flush with and at the same slope as the adjacent surface).

The detectable warning systems are designed to work with concrete surfaces. In areas where the path has an asphalt surface, the engineer must specify an appropriate detectable warning system. In these cases, consider including a short section of concrete that will accommodate any system.

If curb ramps or blended transitions are included in the path design, they ~~shall~~should be parallel to and the full width of the approaching path width. Shared use path crossings shall meet the same grade and cross slope requirements as sidewalks where the grade should not exceed 5%, and the maximum cross slope shall be no more than 2%.

Project design shall include an evaluation of existing driveways to determine if it is feasible to upgrade nonconforming driveway turnouts to meet maximum cross slope criteria. Nonconforming driveways are not required to be upgraded if it is not feasible within the scope of the project.

**Chapter 8 – Pedestrian Facilities** provides additional information regarding accessible design of shared use paths.

### **C.6 Shared Use Path – Roadway Intersections**

Shared use path crossings fall into three basic categories:

- Grade Separated Crossings – Crossings consisting of either a bridge over the roadway or an underpass beneath the roadway.
- Sidepath/Intersection Crossings – Crossings that are located within the functional area of an intersection of two or more roadways and the path is running parallel with the roadway. Sidepath crossings are typically parallel to one of the intersecting roadways. See Figure 9 – 27 Mid-Block and Sidepath Crossings Relative to Intersection Functional Area.
- Midblock Crossings – Crossings that are located outside the functional area of an intersection. See Figure 9 – 27 Mid-Block and Sidepath Crossings Relative to Intersection Functional Area

**Figure 9 – 27 Mid-Block and Sidepath Crossings Relative to Intersection Functional Area**

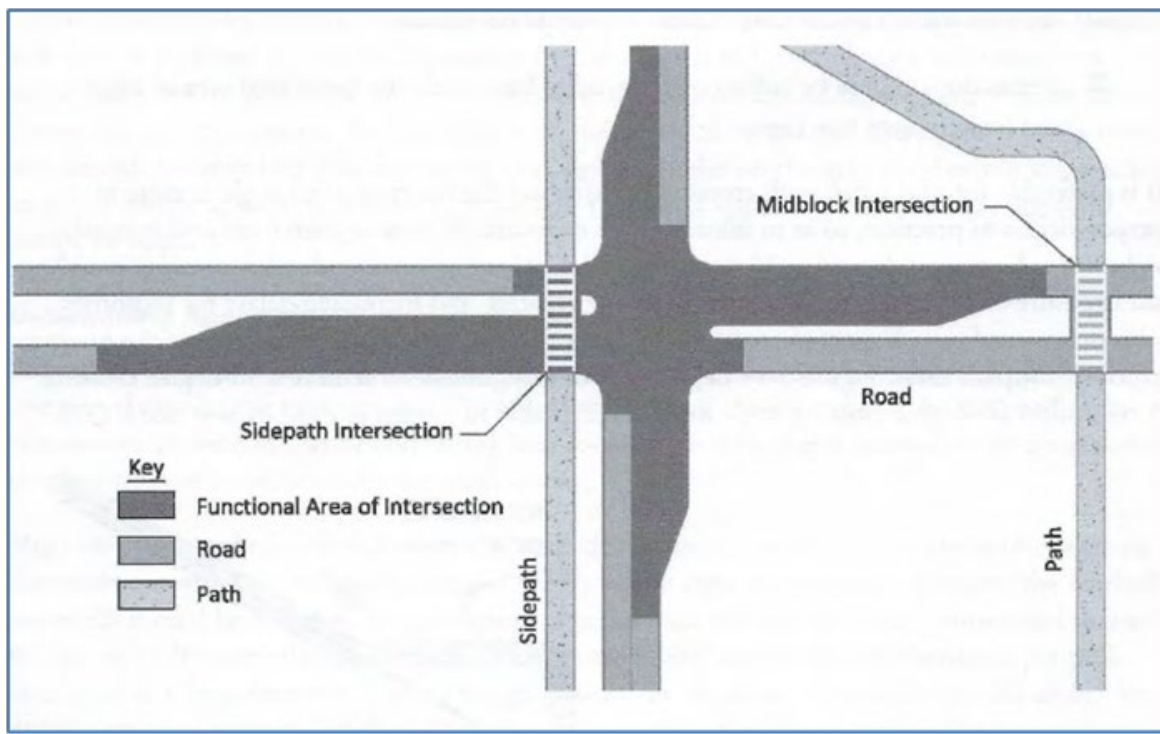

Source: [2012 AASHTO Guide to Bicycle Facilities](#)

### **C.6.a Grade Separated Crossings**

Grade separated crossings involve considerable expense but may be



warranted in certain locations. The need for a grade separated crossing should be based on an engineering analysis to assess existing and future path user characteristics and volume, motor vehicle traffic volume and speed, opportunity for improved at-grade crossings in close proximity, feasibility of accessible design, consistency with existing and future surrounding land use and activities, and long term maintenance costs and responsibility. For further information on conducting such an analysis, see the [AASHTO Guide to Bicycle Facilities, 4th Edition Section 5.2.10](#) and the discussion of grade-separated crossings in the [AASHTO Guide for the Planning, Design, and Operation of Pedestrian Facilities](#).

### **C.6.b Sidepath Crossings**

Sidepath crossings have unique operational and design challenges. One key factor that must be addressed is intersection sight distance. Given their proximity to motor vehicle intersections, sidepath intersection sight distance requirements must consider both what is needed for the drivers of motor vehicles crossing in each direction as well as bicyclists and pedestrians.

In cases where a shared use path is located parallel to and within the roadway corridor, the traffic control on the sidepath shall be consistent with that on the parallel roadway. The path shall be aligned to allow the placement of the stop bar on side streets a minimum of 4 feet in advance of the crosswalk, and crosswalks shall be marked. The crosswalk width shall be equal to or greater than the approach width of the path.

Where a shared use path is located parallel to a high speed roadway and crossing an access or exit ramp or lane, moving the crossing away from the intersection to a midblock location may be considered. This allows for motorists to first enter or exit the high speed roadway and then turn attention to the pathway crossing. When this is done, care should be taken to insure the midblock location is clearly outside the functional area of the intersection and designed accordingly.

See the [AASHTO Guide to Bicycle Facilities, 4th Edition, Sections 5.2.2 and 5.3.4](#) which covers these operational issues in detail and provides several factors to be considered for proper design for further information.

### **C.6.c Midblock Shared Use Path Crossings**

The design of a midblock shared use path crossing is similar in many ways to designing a multi-leg intersection. As with sidepath crossings, a key design element is intersection sight distance. The basic criteria for establishing intersection sight distance for shared use path crossings is based on the same methodology presented in the **AASHTO Greenbook** for conventional intersections but with adjustments to account for the design vehicle and design speed of the shared use path. As with conventional intersections, the dimensions of the clear sight triangle are dependent on the type of traffic control.

The **AASHTO Guide to Bicycle Facilities, 4th Edition Section 5.3.2** provides additional information on the details and methodology for the proper design of midblock crossings including several examples.

#### **C.6.c.1 Intersections with Yield Control**

The **AASHTO Guide to Bicycle Facilities** indicates that it is preferable to provide shared use path intersection sight distance based on yield control for all midblock crossings. See Figure 9 – 28 Yield Sight Triangles and Table 9 – 2 Formulas for Lengths of Roadway and Path Legs – Yield Condition and the formulas to compute the lengths of the roadway leg (a) and path leg (b) for yield control. Table 9 – 3 Intersection Sight Distance Calculated Lengths of Roadway and Path Lengths provides calculated sight distance values based on Figure 9 – 28 and Table 9 – 2 for a range of roadway design speeds and a shared use path design speed of 18 mph.

**Figure 9 – 28 Yield Sight Triangles**

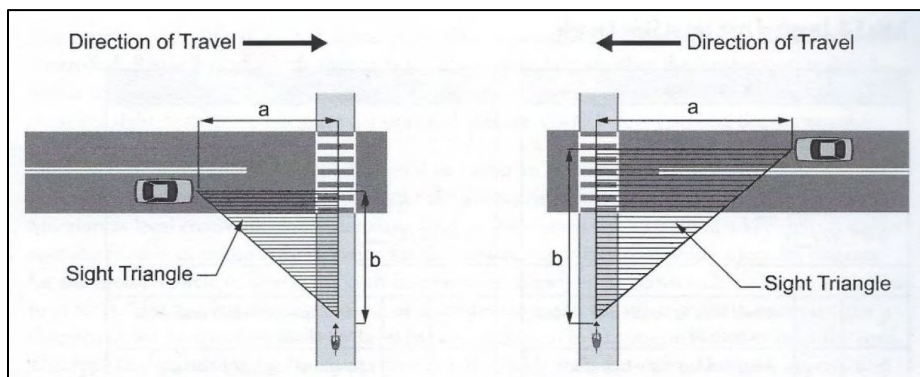

**Table 9 – 2 Formulas for Lengths of Roadway and Path Legs – Yield Condition**

<u>Length of Roadway Leg (a)</u>	<u>Length of Path Leg (b)</u>
$t_a = \frac{S}{1.47 V_{\text{path}}}$ $t_g = t_a + \frac{w + L_a}{1.47 V_{\text{path}}}$ $a = 1.47 V_{\text{road}} t_g$	$t_a = \frac{1.47 V_e - 1.47 V_b}{a_i}$ $t_g = t_a + \frac{w + L_a}{0.88 V_{\text{road}}}$ $b = 1.47 V_{\text{path}} t_g$
<u>t<sub>g</sub></u> ≡ Travel time to reach and clear the path (s)	<u>t<sub>g</sub></u> ≡ Travel time to reach and clear the path (s)
<u>a</u> ≡ length of leg sight triangle along the path approach (ft)	<u>b</u> ≡ Length of leg sight triangle along the path approach (ft)
<u>t<sub>a</sub></u> ≡ Travel time to reach the road from the decision point for a path user that does not stop (s)	<u>t<sub>a</sub></u> ≡ Travel time to reach the path from the decision point for a motorist that does not stop (s).
<u>w</u> ≡ Width of the intersection to be crossed (ft)	<u>V<sub>e</sub></u> ≡ Speed at which the motorist would enter the intersection after deceleration (mph) (assumed 0.60 x road design speed)
<u>L<sub>a</sub></u> ≡ Typical bicycle length = 6 ft (see AASHTO Guide for other design users)	<u>V<sub>b</sub></u> ≡ Speed of which braking by the motorist begins (mph) (same as road design speed)
<u>V<sub>path</sub></u> ≡ Design speed of the path (mph)	<u>a<sub>i</sub></u> ≡ Motorist deceleration rate (ft/s <sup>2</sup> ) on intersection approach when braking to a stop not initiated (assume 5.0 ft/s <sup>2</sup> )
<u>V<sub>road</sub></u> ≡ Design speed of the road (mph)	<u>w</u> ≡ Width of intersection to be crossed.
<u>S</u> ≡ Stopping sight distance for the path user traveling at design speed.	<u>L<sub>a</sub></u> ≡ Length of the design vehicle (ft)
	<u>V<sub>path</sub></u> ≡ Design speed of the path
	<u>V<sub>road</sub></u> ≡ Design speed of the road (mph)

**Table 9 – 3 Intersection Sight Distance  
 Calculated Lengths of Roadway and Path Lengths**

<b><u>Roadway Design Speed (mph)</u></b>	<b><u>Length of Roadway Leg a (feet)</u></b>		<b><u>Length of Path Leg b (feet)</u></b>
	<b><u>Length for Crossing 2 Roadway Traffic Lanes</u></b>	<b><u>Additional Length for each Additional Traffic Lane Crossed</u></b>	
<u>20</u>	<u>182</u>	<u>13</u>	<u>109</u>
<u>25</u>	<u>228</u>	<u>17</u>	<u>115</u>
<u>30</u>	<u>273</u>	<u>20</u>	<u>124</u>
<u>35</u>	<u>319</u>	<u>23</u>	<u>136</u>
<u>40</u>	<u>364</u>	<u>27</u>	<u>148</u>
<u>45</u>	<u>410</u>	<u>30</u>	<u>161</u>
<u>50</u>	<u>456</u>	<u>33</u>	<u>174</u>
<u>55</u>	<u>501</u>	<u>37</u>	<u>188</u>
<u>60</u>	<u>547</u>	<u>40</u>	<u>202</u>

**Notes:**

**1. Above lengths a and b based on:**

- Design Speed of Path = 18 mph
- Stopping Sight Distance for path user = 134 feet
- Shared Use Path Width at Roadway Crossing = 12 feet
- Path Design Vehicle Length = 6 feet (bicycle)
- Road Width = 2 traffic lanes @ 12 feet each = 24 feet
- Roadway Design Vehicle Length = 19 feet (passenger vehicle)
- Roadway Approach Grade ≤ 3.0%
- Path Approach Grade = 0.0%

For other design conditions see AASHTO Guide to Bicycle Facilities.

**2. The line of sight is measured 2.7 feet above the surface of the path and roadway.**

### **C.6.c.2 Intersections with Signal Control or Stop Control**

Where intersection sight distance based on yield control cannot be provided, signal control or stop control should be considered. For midblock crossings with signal control or stop control on either the roadway or the path, the roadway and path approaches shall provide the minimum stopping sight distance to obey the control and execute a stop before entering the intersection. An unobstructed view of a path user located at the stopped position on the path should be visible to the motorist and vice versa. The [AASHTO Guide for the Development of Bicycle Facilities](#) provides additional details for the proper design of signal control and stop control intersections.

### **C.7.6 Structures**

The minimum clear width on structures ~~shall~~should be the same as the approach ~~width of the~~ shared use path, plus ~~a~~the minimum 2 foot wide clear area on each side should be provided.~~s.~~ Access by emergency, patrol and maintenance vehicles should be considered in establishing the design clearances of structures on shared use paths. Where practical, a path vertical clearance of 10 feet (on the structure) is desirable for adequate vertical shy distance.

Where compliance with the requirement for a maximum running slope of 5% is not practicable due to existing terrain or infrastructure, right-of-way availability, a notable natural feature, or similar existing physical constraints, compliance is required to the extent practicable.

Ramps on new structures that are part of a shared use path and serve as the accessible route shall have a running slope between 5% minimum and 8.3% maximum. The cross slope of ramp runs shall be 2% maximum~~not steeper than 1:12 and cross slope not steeper than 1:48~~. Landings are required at the top and the bottom of each ramp run.

### **C.8.7 Pavement Markings and Signage**

The MUTCD regulates the design and use of all traffic control devices on shared use paths. Figure 9 – ~~29~~7 Sign Placement on Shared Use Paths provides the minimum criteria for the placement of signs along or over a shared use path. The maximum height from the outside edge of the path to the bottom elevation of a sign is five feet. Signs on shared use paths should follow the dimensions provided

in **Table 9B-1 Bicycle Sign and Plaque Sizes, MUTCD**. Guidance on the placement of stop or yield lines and crosswalks on roadways intersecting with shared use paths is provided in the [MUTCD, Part 3](#).

**Figure 9 – 297 Sign Placement on Shared Use Paths**

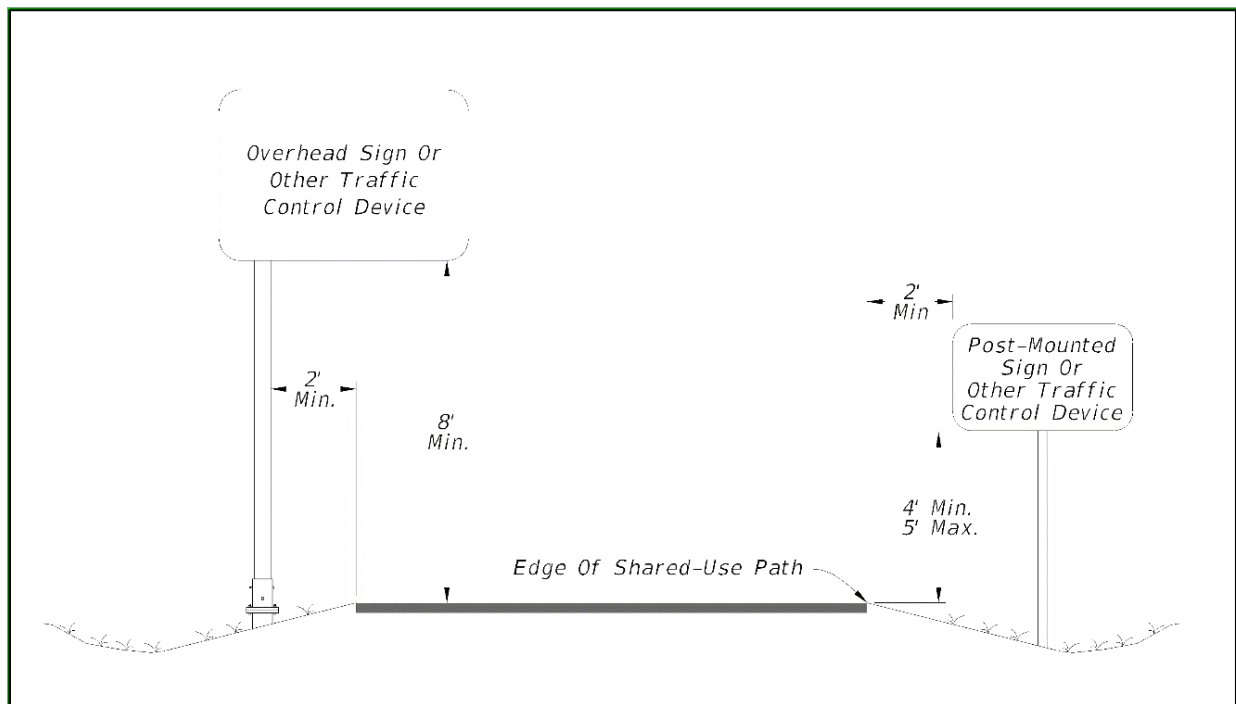

## D RAILROAD CROSSINGS

Railroad-highway grade crossings should ideally be at a right angle to the rails. This can be accomplished either as a separate path or a widened shoulder. The greater the crossing deviated from this ideal crossing angle, the greater is the potential for a bicyclist's front wheel to be trapped in the flangeway, causing loss of steering control. If the crossing angle is less than approximately 45 degrees, an additional paved shoulder of sufficient width should be provided to permit the bicyclist to cross the track at a safer angle, preferable perpendicularly. Where this is not possible, and where train speeds are low, commercially available compressible flangeway fillers may enhance bicyclist operation. It is also important that the roadway approach be at the same elevation as the rails. For more information, see Figure 4 – 28 Correction for Skewed Railroad Grade Crossing – Separate Pathway in the [AASHTO Guide for the Development of Bicycle Facilities](#).



## E STRUCTURES

All new bridges over roadways and shared use paths shall be designed to meet the vertical clearance standards specified in **Chapter 3, Section C.7.j.4.(b)**, and **Chapter 17, Section C.3.b**.

All bridges that include provisions for pedestrians shall provide pedestrian accommodations and design considerations that meet the provisions of the ADA.

Bridges over roadways should be covered or screened to reduce the likelihood of objects being dropped or thrown below. If the bridge is enclosed, the visual tunnel effect may require widening the bridge to provide a feeling of security for all bridge users. The area adjacent to overpasses may be fenced to prevent unsafe crossings and to channel pedestrians to the vertical separation structure.



## F REFERENCES FOR INFORMATIONAL PURPOSES

- USDOT/FHWA ADA Standards for Accessible Design (ADAAG)  
<http://www.access-board.gov/guidelines-and-standards/buildings-and-sites/about-the-ada-standards/ada-standards><https://www.fhwa.dot.gov/programadmin/pedestrians.cfm>
- AASHTO – Guide for the Development of Bicycle Facilities, 2012, 4th Edition  
<https://bookstore.transportation.org/><https://store.transportation.org/Common/DownloadContentFiles?id=1096>
- NACTO Urban Streets Design Guide  
<http://nacto.org/usdg>
- FHWA Policy Memo for Flexibility in Pedestrian and Bicycle Facility Design  
[https://www.fhwa.dot.gov/environment/bicycle\\_pedestrian/guidance/http://www.fhwa.dot.gov/environment/bicycle\\_pedestrian/guidance/design\\_guidance/design\\_flexibility.cfm](https://www.fhwa.dot.gov/environment/bicycle_pedestrian/guidance/http://www.fhwa.dot.gov/environment/bicycle_pedestrian/guidance/design_guidance/design_flexibility.cfm)
- ~~Storm Drain Handbook~~[Drainage Handbooks](#), Florida Department of Transportation, October 2014  
<https://www.fdot.gov/roadway/drainage/manualsandhandbooks.shtm><http://www.dot.state.fl.us/rddesign/Drainage/files/StormDrainHB.pdf>
- ~~Manual on~~
- ~~Manual on~~ Uniform Traffic Control Devices, May 2012  
[http://mutcd.fhwa.dot.gov/pdfs/2009r1r2/pdf\\_index.htm](http://mutcd.fhwa.dot.gov/pdfs/2009r1r2/pdf_index.htm)
- ~~NACTO, Urban Bikeway Design Guide~~  
<https://nacto.org/publication/urban-bikeway-design-guide/cycle-tracks/>

**THIS PAGE INTENTIONALLY LEFT BLANK**

## CHAPTER 10

### MAINTENANCE AND RESURFACING

A	INTRODUCTION .....	10-1
B	MAINTENANCE .....	10-1
B.1	Objectives .....	10-1
B.2	Policy .....	10-1
B.3	Identification of Needs.....	10-2
B.3.a	Inspection.....	10-2
B.3.b	Crash Records.....	10-2
B.4	Establishment of Priorities.....	10-3
B.5	Establishment of Procedures .....	10-3
B.5.a	Emergency Maintenance .....	10-3
B.5.b	Routine Maintenance .....	10-4
B.5.c	Special Maintenance.....	10-5
B.5.d	Pavement Maintenance .....	10-5
C	RESURFACING .....	10-7
C.1	Accessibility Requirements .....	10-7
C.2	Railroad-Highway Grade Crossing Near or Within Project Limits .....	10-8
C.3	Safety Improvements .....	10-8
C.3.a	Pavement Safety Edge .....	10-8
C.4	Federal Aid Project Requirements .....	10-11
D	REFERENCES FOR INFORMATIONAL PURPOSES .....	10-13

### FIGURES

Figure 10 – 1	Two Lane Road with Safety Edge .....	10-9
Figure 10 – 2	Safety Edge Detail (No Paved Shoulders) .....	10-11

**THIS PAGE INTENTIONALLY LEFT BLANK**

## CHAPTER 10

### MAINTENANCE AND RESURFACING

#### A INTRODUCTION

In order to provide for the safe and efficient movement of all modes of traffic, it is essential to maintain all aspects of the road and right of way at the highest reasonable level of safety. Improvements consistent with upgrading safety standards or accommodating changes in traffic are also required to maintain the facility in a quality condition. Maintenance and resurfacing are costly operations; therefore, every effort should be made to provide the maximum safety benefit from each operation. The fact that a major portion of the maintenance effort is necessary to merely preserve the economic investment in a facility should not be considered as justification for sacrificing the requirements for maintaining or improving the safety characteristics of a street or highway.

#### B MAINTENANCE

##### B.1 Objectives

The major objectives of a maintenance program include the following:

- Maintain all highway features and components in the best possible condition.
- Improve sub-standard features, with the ultimate goal to at least meet minimum standards.
- Provide for minimum disruptions and hazards to traffic during maintenance operations.
- Location and reporting of inadequate safety features.

##### B.2 Policy

Each highway agency responsible for maintenance shall develop and maintain a program of highway maintenance for the entire highway network under its jurisdiction. This program should include the following activities:

- Identify needs

- Establish priorities
- Establish procedures
- Establish and maintain a regular program of maintenance for all aspects

The program should be regularly evaluated and suitably modified to promote the maintenance of streets and highways that result in the best practicable condition.

### **B.3 Identification of Needs**

The identification of maintenance needs is the first stage in the development of a successful maintenance program, and is required when any portion of the highway system is in a sub-standard condition. Action is also required to correct any situation which is hazardous or may become hazardous in the near future. This may be accomplished by both regular inspection of the highway network and proper analysis of crash records.

#### **B.3.a Inspection**

Periodic and systematic inspection of the entire highway network under each agency's jurisdiction is required to identify situations requiring improvements, and corrections or repairs. These inspections should be conducted by maintenance or traffic operations personnel, or other qualified personnel who are trained in the aspects of highway maintenance requirements.

#### **B.3.b Crash Records**

A regular program of crash investigations, record keeping, and analysis should be established to provide information for recommended highway modification and corrective maintenance requirements. Cooperation among maintenance, traffic operations, and police agencies is required, and activities of these agencies should be coordinated in accordance with the guidelines set forth in the ***National Highway Traffic Safety Administration (NHTSA) Program Guideline No. 21 (II), Identification and Surveillance of Crash Locations***. Inspection of the highway network and analysis of crash records should be utilized to provide feedback for modification of design and construction procedures.

## **B.4 Establishment of Priorities**

The maintenance activities determined to be necessary by the identification program should be carried out on a priority basis. The establishment of priorities should be based, to a large extent, upon the objective of promoting highway safety. A high priority should be given to the improvement or correction of situations that may result in fatal or serious crashes. Preservation of highway investment and promotion of efficient traffic operations are important maintenance objectives. Every effort should be made to ensure the highest safety payoff from the maintenance dollar.

## **B.5 Establishment of Procedures**

Standard procedures and methods for maintenance operations should be established for efficient, rapid, and safe completion of the required work. All maintenance work shall be conducted in accordance with the Standards set forth in **Chapter 11 – Work Zone Safety**. Each maintenance agency should develop its own Maintenance Manual or utilize the Maintenance Manuals of ~~the~~ the FDOT. Such manuals should specify the methods, procedures, equipment, personnel qualifications, and other aspects of the work necessary to ensure successful completion of maintenance operations. Procedures should be developed for emergency, routine, and special operations.

### **B.5.a Emergency Maintenance**

Emergency maintenance operations are those required to immediately restore the highway to a safe condition. Emergency maintenance work should be carried out by personnel who are specially trained and qualified. Work units, which should be available on a twenty-four hour basis, should be connected with the emergency response communications system. Emergency operations would include the following:

1. The removal of debris from crashes, cargo spillage, or other causes. This activity should be conducted in accordance with the guidelines set forth in the **NHTSA Program Guideline No. 16, Debris Hazard Control and Cleanup**.
2. Replacement of inoperative traffic control devices.
3. Repair or replacement of damaged highway safety components such as lighting, traffic control devices, redirection devices, and energy absorbing devices.

4. Repair or correction of any situation that provides an immediate or unexpected hazard to the public.
5. Assistance in any activity during emergency response operations.

### **B.5.b Routine Maintenance**

Routine maintenance operations are those that may be predicted and planned in advance. These operations, which may be preventive or corrective in nature, should be conducted on a regularly scheduled basis using standard procedures. Proper scheduling of these operations should be utilized to provide minimum disruptions and hazards to the driving public. Routine maintenance may include operations such as:

1. Cleaning and debris removal from the pavement, shoulders, and roadside clear zones.
2. Mowing and other vegetation control operations to provide a smooth recovery area and to maintain proper sight distance.
3. Cleaning and inspection of gutters, ditches, and other drainage structures.
4. Structural inspection and preventive maintenance on bridges and other structures.
5. Cleaning, replacement, and maintenance of roadway lighting fixtures.
6. Replacement and maintenance of traffic control devices.
7. Inspection and maintenance of redirection and energy absorbing devices (**Chapter 4 – Roadside Design**).
8. Inspection and maintenance of emergency response communication systems and access facilities.
9. Inspection and maintenance of pavement and shoulders, with particular emphasis on maintaining shoulders flush with the pavement (**Chapter 5 – Pavement Design and Construction**).
10. Inspection and maintenance of all highway components and safety features.
11. Inspection and maintenance of pedestrian pavements, crossings, etc., with particular emphasis on sidewalk cracks, joint separations, accumulated debris, adjacent landscape materials, etc.).



12. Thin pavement overlay that is intended to preserve the pavement, retard its future deterioration and maintain its functional condition.

### **B.5.c Special Maintenance**

Special maintenance operations are defined as those projects that are neither urgent nor routine in nature, but are occasionally required to improve or maintain a street or highway in a quality condition. Since these projects can be planned in advance of the initiation of any work, procedures that provide for efficient, rapid, and safe operations can be developed. To avoid continuing disruptions of traffic, the quality and durability of these improvements, corrections, and repairs should be maintained at the highest practicable level. Special maintenance should include the upgrading of the highway safety features, as well as the repair or replacement of damaged or deteriorated highway components. These operations should be designed to upgrade or maintain the street or highway in accordance with the Standards presented in this Manual.

### **B.5.d Pavement Maintenance**

The primary purpose of pavement maintenance is to ensure the pavement characteristics prescribed in **Chapter 5 – Pavement Design And Construction**, are reasonably maintained. Each agency with responsibility for maintenance of streets and highways shall establish a meaningful pavement maintenance system (including shoulders and drainage structures) for the entire system under its jurisdiction. This program should include:

1. A process that monitors the serviceability of the existing streets and highways and identifies the pavement sections that are inadequate.
2. A systematic plan of maintenance activities designed to correct structural deficiencies and to prevent rapid deterioration.
3. A preservation program, with assigned priorities, designed to resurface, reconstruct, or replace pavements when they are no longer structurally serviceable.

Pavement maintenance requires a substantial portion of the total maintenance budget for streets and highways. It is necessary to ensure highway safety. The reduction of hydroplaning and splashing is essential for promoting safe and efficient operation during wet weather conditions. The elimination of driving discomfort, and vehicle damage caused by

deteriorated pavements, provides additional economic justification for maintaining the pavement in a fully serviceable condition.

It is recognized that a comprehensive preservation program is expensive. Adequate financing is required to successfully carry out these activities. The establishment of appropriate budget priorities and careful planning can assist in developing and conducting a pavement maintenance and preservation program that will, within a reasonable number of years, bring substandard pavements up to the required level of serviceability and will maintain the adequacy of the entire system.

## C RESURFACING

In addition to the design criteria provided in this chapter, the [United States Department of Transportation ADA Standards for Transportation Facilities \(2006\)](#) as required by [49 C.F.R 37.41 or 37.43](#), [United States Department of Justice ADA Standards \(2010\)](#) as required by [28 C.F.R 35 \(title II\) and 36 \(title III\)](#), and the [2020 Florida Building Code, Accessibility, 7th Edition](#) as required by [61G20-4.002](#) contains ADA requirements for accessibility in the public right of way, for transportation facilities, and for sites, facilities, buildings, and elements by people with disabilities.

[The Public Rights-of-Way Accessibility Guidelines \(PROWAG\)](#) provides additional information for the design of pedestrian facilities.

~~as required by [49 C.F.R 37.41 or 37.43](#) and the ~~as required by [61G20-4.002](#)~~ impose additional requirements for the design and construction of resurfacing projects.~~

### C.1 Accessibility Requirements

If new sidewalk and driveway construction or reconstruction is included on resurfacing projects they shall be designed to meet the requirements of **Section C.7.d** of **Chapter 3 – Geometric Design** and **Chapter 9 – Pedestrian Facilities**. Project design should include an evaluation of existing driveways to determine if it is feasible to upgrade nonconforming driveways.

Existing detectable warnings and curb ramps shall be brought into compliance. This includes installing new detectable warnings for both flush shoulder and curbed roadway connections and signalized driveways where none exist or do not meet current requirements. New curb ramps shall be provided on curbed roadways where none exist and existing substandard curb ramps shall be replaced. Existing ramps not meeting detectable warning requirements which otherwise comply with orientation, slope and width criteria shall be retrofitted with detectable warnings.

Where existing right of way is inadequate or conflicts occur with existing features that cannot be practicably relocated or adjusted (e.g. driveways, drainage inlets, signal poles, pull boxes, utility poles, etc.), pedestrian accessibility shall be provided to the maximum extent feasible, with appropriate documentation signed and sealed by a Professional Engineer (EOR). Other than meeting detectable warning and curb ramp requirements, existing sidewalks and driveways are not required to be upgraded for the sole purpose of meeting requirements for accessibility unless included in the project scope.

## C.2 Railroad-Highway Grade Crossing Near or Within Project Limits

Federal-aid projects must be reviewed to determine if a railroad-highway grade crossing is within the limits of or near the terminus of the project. If such railroad-highway grade crossing exists, the project must be upgraded to meet the requirements of the [Manual on Uniform Traffic Control Devices \(2009 Edition with Revision Numbers 1 and 2, May 2012\) \(MUTCD\)](#) in accordance with [Title 23, United States Code \(U.S.C.\), Chapter 1, Section 109\(e\)](#) and [23 C.F.R. 646.214\(b\)](#). Please refer to Section C of [Chapter 7 – Rail-Highway Crossings](#) for further information.

## C.3 Safety Improvements

Local agencies should strive to upgrade the safety of their facilities during scheduled maintenance intervals especially during pavement resurfacing projects. Particular attention should be paid to improving pedestrian and bicyclist safety using strategies such as crosswalks and bicycle facilities. Investments should also be made in improved guardrail end treatments and bridge-end transitions on high speed facilities.

### C.3.a Pavement Safety Edge

Many low-cost strategies exist to improve the long-term safety of streets and highways. One such strategy is the pavement Safety Edge. The Safety Edge provides a higher probability of a vehicle returning safely to the travel lane when it drifts off the pavement. ~~It~~ [The Safety Edge](#) is a wedge-shaped transition of the structural pavement to the unpaved shoulder. The wedge shape eliminates tire scrubbing against the pavement edge and improves vehicle stability as it crosses a drop-off.

The Safety Edge is particularly effective when providing a smooth transition from pavement to shoulder when vertical drop-offs exceed 2 inches. Construction of the Safety Edge typically includes initially pulling the unpaved shoulder for pavement structural course, and then backfilling onto the Safety Edge with installation of sod or turf. The Safety Edge is very effective in mitigating the severity of road-departure crashes should the unpaved shoulder erode away between maintenance intervals.

[A Safety Edge treatment should be provided adjacent to the travel lane on roadways:](#)

- [without curb or paved shoulders.](#)

- with a posted speed of 45 mph or greater, and
- a history of lane departure crashes.

Details for the Safety Edge are included in Figures 10 – 1 Two Lane Road with Safety Edge and 10 – 2 Safety Edge Detail (No Paved Shoulder). ~~Safety Edge is most beneficial when should be constructed adjacent to the pavement edge on rural roadways with no paved shoulder and posted speeds 45 mph and above.~~

Additional information on Safety Edge can be found at **FHWA's Office of Safety – Safety Edge**, including a Design and Construction Guide, Guide Specification, ~~and~~ Safety Evaluation Tech Brief and Case Studies. **FHWA's Crash Modification Factors Clearinghouse** also provides information on the performance of safety edge. The ~~The~~ FDOT has a **Developmental Specification for Safety Edge – Dev330SE** on the FDOT's web site which may be used if approved by the agency having jurisdiction.

**Figure 10 – 1 Two Lane Road with Safety Edge**

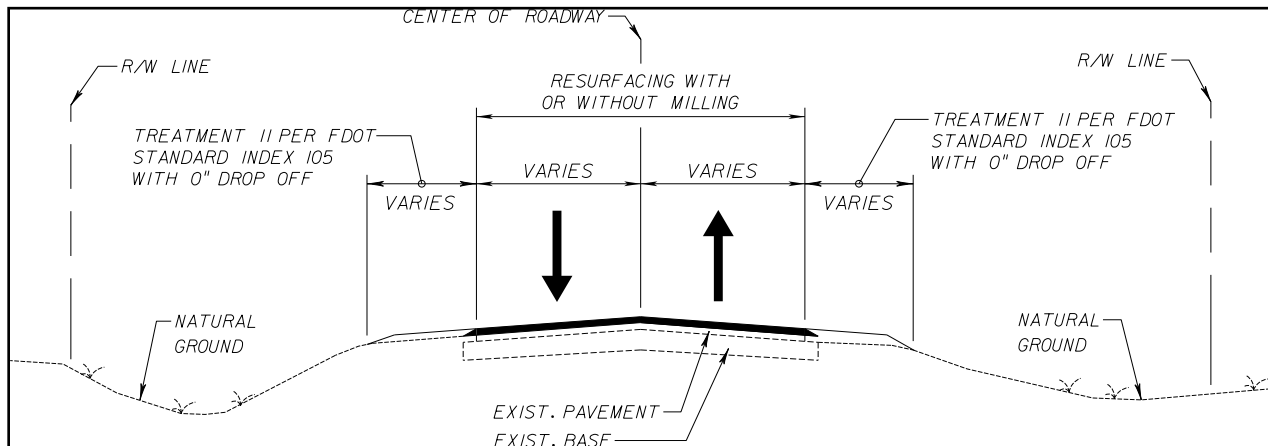

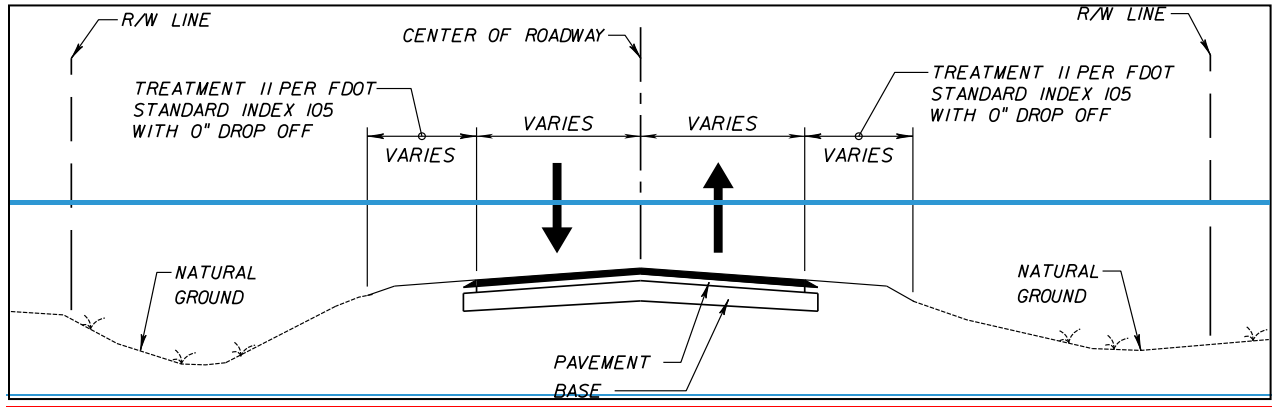

**Figure 10 – 2 Safety Edge Detail (No Paved Shoulders)**

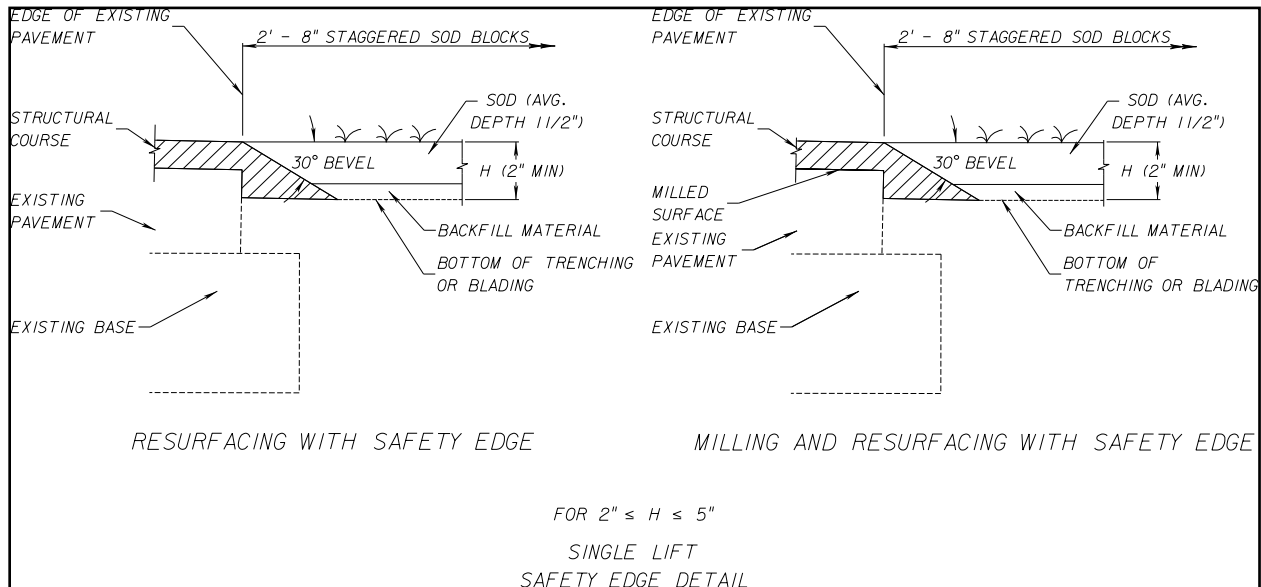

#### C.4 Federal Aid Project Requirements

The following are the minimum requirements that a local highway resurfacing project scope must contain for federal-aid assistance including projects in the Local Agency Program (LAP):

1. Rework shoulders to be flush with the pavement and establish turf along the pavement edge.
2. Upgrade or replace existing roadside hardware (guardrail) as necessary for compliance with Federal criteria for 3R projects (as summarized in the [Department FDOT Design Manual, Chapter 215 Roadside Safety](#)).
3. Meet the [latest Manual on Uniform Traffic Control Devices \(2009 Edition with Revision Numbers 1 and 2, May 2012\) \(MUTCD\)](#) standards for signing and pavement marking.
4. Construct or reconstruct, as appropriate, curb cuts and ramps to meet current accessibility requirements.
5. Upgrade the safety of the project by mitigating the impact of crashes involving vehicles, bicycles, and pedestrians.

Note: The local agency may contact the FDOT District Safety Office and

determine locations within the project with crash rates higher than average for similar facility type. The local agency may then identify the causes of the crashes from a review of crash report data provided by the FDOT District Safety Office. Based on this analysis, the local agency may then specify the appropriate crash mitigation measures (additional guardrail, signing, vibratory/audible pavement marking, designated crosswalks or other prudent safety-enhancing strategies).

6. Upgrade railroad crossings to meet the [latest Manual on Uniform Traffic Control Devices \(2009 Edition with Revision Numbers 1 and 2, May 2012\) \(MUTCD\)](#) requirements in accordance with [Title 23, United States Code \(U.S.C\), Chapter 1, Section 109\(e\)](#) and [23 C.F.R. 646.214\(b\)](#). Please refer to **Section C** of **Chapter 7 – Rail-Highway Crossings** for further information.



## D REFERENCES FOR INFORMATIONAL PURPOSES

The following is a list of publications that may be referenced for further guidance:

- FHWA Pavement Preservation Definitions, HIAM-20, September 12, 2005,  
<http://www.fhwa.dot.gov/pavement/preservation/091205.cfm>
- NCHRP Synthesis 417: Geometric Design Practices for Resurfacing, Restoration, and Rehabilitation,  
<https://www.trb.org/Publications/Blurbs/165650.aspx>
- [FHWA Center for Accelerating Innovation – Safety Edge](https://www.fhwa.dot.gov/innovation/everydaycounts/edc-1/safetyedge.cfm)  
<https://www.fhwa.dot.gov/innovation/everydaycounts/edc-1/safetyedge.cfm>

**THIS PAGE INTENTIONALLY LEFT BLANK**

## CHAPTER 11

### WORK ZONE SAFETY AND MOBILITY

A	INTRODUCTION .....	11-1
B	REGULATORY REQUIREMENTS .....	11-2
C	TRANSPORTATION MANAGEMENT PLAN.....	11-3
D	TEMPORARY TRAFFIC CONTROL PLAN (TTCP) .....	11-6
D.1	Type of Operation .....	11-6
D.2	Nature of the Work Zone.....	11-7
D.3	TTCP Details.....	11-9
D.3.a	Short Term Transverse Rumble Strips .....	11-10
D.3.b	Temporary Raised Rumble Strip Sets .....	11-10
D.4	Work Scheduling .....	11-11
D.5	Coordination.....	11-13
D.6	Number and Width of Travel Lanes, Bike Lanes, Sidewalks, and Shared Use Paths .....	11-14
D.7	Clear Zones, Above-Ground Hazards, Drop-Offs, and Temporary Barriers .....	11-14
D.8	Work Affecting Pedestrian and Bicycle Facilities .....	11-18
D.8.a	Pedestrian Facilities .....	11-18
D.8.b	Bicycle Facilities .....	11-18
D.9	Typical Application Examples .....	11-20
E	TRANSPORTATION OPERATIONS PLAN.....	11-37
E.1	Contracts and Permits.....	11-37
E.1.a	Utilities.....	11-37
E.1.b	Wildlife Sensitive Lighting.....	11-37
E.2	Inspection and Supervision .....	11-38
F	PUBLIC INFORMATION PLAN .....	11-38
G	EVALUATION OF PROGRAM .....	11-39

## TABLES

Table 11 – 1 Work Zone Sign Spacing “X” .....	11-21
Table 11 – 2 Taper Length “L” .....	11-21
Table 11 – 3 Buffer Length “U” .....	11-22
Table 11 – 4 Channelizing Device Spacing .....	11-22

## FIGURES

Figure 11 – 1 TMP Development .....	11-4
Figure 11 – 2 Two-Lane Roadway, Single Lane Closure Using Flaggers .....	11-24
Figure 11 – 3 Multi-Lane Roadway, Single Lane Closure .....	11-25
Figure 11 – 4 Sidewalk/Shared Use Path Diversion (Temporary Sidewalk/Shared Use Path) .....	11-26
Figure 11 – 5 Sidewalk/Shared Use Path Detour (Closure with Reroute) .....	11-28
Figure 11 – 6 Bicycle Lane Closure Without Detour .....	11-29
Figure 11 – 7 Bicycle Lane Closure With On-Road Detour .....	11-31
Figure 11 – 8 Shared Use Path Closure with a Diversion .....	11-33
Figure 11 – 9 On-Road Detour for Shared Use Path .....	11-35
Figure 11 – 10 Paved Shoulder Closure with Bicycle Diversion onto Temporary Path .....	11-36

**THIS PAGE INTENTIONALLY LEFT BLANK**



## CHAPTER 11

### WORK ZONE SAFETY AND MOBILITY

#### A INTRODUCTION

Construction, maintenance, and utility work, along with traffic incident management, are ~~roadwork~~ operations that may create highway safety and mobility challenges. The changes to normal traffic flow and the introduction of unexpected travelling conditions at many work zones may generate hazardous situations and serious traffic conflicts. A comprehensive plan for work zone safety is required to minimize the risks and effects of these ~~roadwork~~ operations. These comprehensive plans are known as transportation management plans. Any activity within a street, ~~the~~ highway or shared use path corridor/right of way shall follow~~be subjected to~~ the requirements of this chapter~~work zone safety~~.

The general objective of a transportation management plan is to protect workers, traffic incident responders, pedestrians, bicyclists, and motorists during work zone operations. This may be achieved by meeting the following:

- Provide adequate advance warning and information about upcoming work zones
- Promote the use of the appropriate traffic control and protection devices
- Provide pedestrians, ~~bicyclists~~bicyclists, and motorists clear information to understand how to navigate through or around the work zone
- Provide accessible and continuous routes for pedestrians through, in, and/or around construction or maintenance work zones at least to the same level of accessibility that existed prior to the project
- Reduce the consequences of an out-of-control vehicle
- Provide safe access and storage for equipment and material
- Promote the speedy completion of projects (including thorough cleanup of the site)

## **B REGULATORY REQUIREMENTS**

Each agency with responsibilities for construction, maintenance, utility, or traffic incident management, or any roadwork operations on streets and highways shall develop and maintain a program of work zone safety, as set forth in the **Manual on Uniform Traffic Control Devices, 2009 Edition (MUTCD)**, and adopted by **Rule 14 – 15.010, F.A.C.** Additional requirements related to all highway construction projects financed in whole or in part with federal-aid highway funds are provided in **Title 23 Code of Federal Regulations (CFR) 630 Subpart J**, more commonly known as the **Work Zone Safety and Mobility Rule**, and **Temporary Traffic Control Devices Rule (Subpart K)**,~~s~~  
~~financed in whole or in part with federal-aid highway funds.~~

When an existing pedestrian facility is in place, an accessible and continuous route for pedestrians through, in, and/or around construction or maintenance work zones must be provided, -in compliance with the **2006 Americans with Disabilities Act Standards for Transportation Facilities** as required by **49 C.F.R 37.41 – Construction of Transportation Facilities by Public Entities** or **37.43 - Alteration of Transportation Facilities by Public Entities**. -The -**2017 Florida Accessibility Code** also includes requirements that apply to work zones, as required by **F.A.C. 61G20-4.002**.



## **C TRANSPORTATION MANAGEMENT PLAN**

A Transportation Management Plan (TMP) lays out a set of strategies for managing work zone impacts of a project. The TMP helps to expand mitigation of work zone impacts beyond traffic safety and control to also address mobility for all users. The scope and content of the TMP required for a project are based on the work zone policies, expected work zone impacts of the project, and whether a project is determined to be significant. For all projects, the TMP will contain a Temporary Traffic Control Plan (TTCP) that addresses traffic safety and control through the work zone and is consistent with the provisions under Part 6 of the **MUTCD**.

If a project is expected to be significant, the TMP for that project must also contain both transportation operations and public information components. The Transportation Operations Plan (TOP) addresses operations and management of the transportation system in the work zone impact area. Examples of TOP strategies include travel demand management, signal retiming, use of Intelligent Transportation Systems (ITS), speed enforcement, and traffic incident management.

The Public Information Plan (PIP) addresses communication with the public and concerned stakeholders, both before and during the project, about the project, what to expect in and around the work zone, and available travel alternatives. Examples of PIP strategies include using brochures, web sites, radio, and/or variable message signs to disseminate this information both pre-trip and in-route.

A significant project is defined as one that alone or in combination with other concurrent projects nearby is anticipated to cause sustained work zone impacts that are greater than what is considered tolerable based on policy or engineering judgement.

Figure 11 – 1 TMP Development provides an overview of the steps taken in developing a Transportation Management Plan. Further information on developing TMPs for projects can be found on [FHWA's Work Zone Management](#) web page.

**Figure 11 – 1 TMP Development**

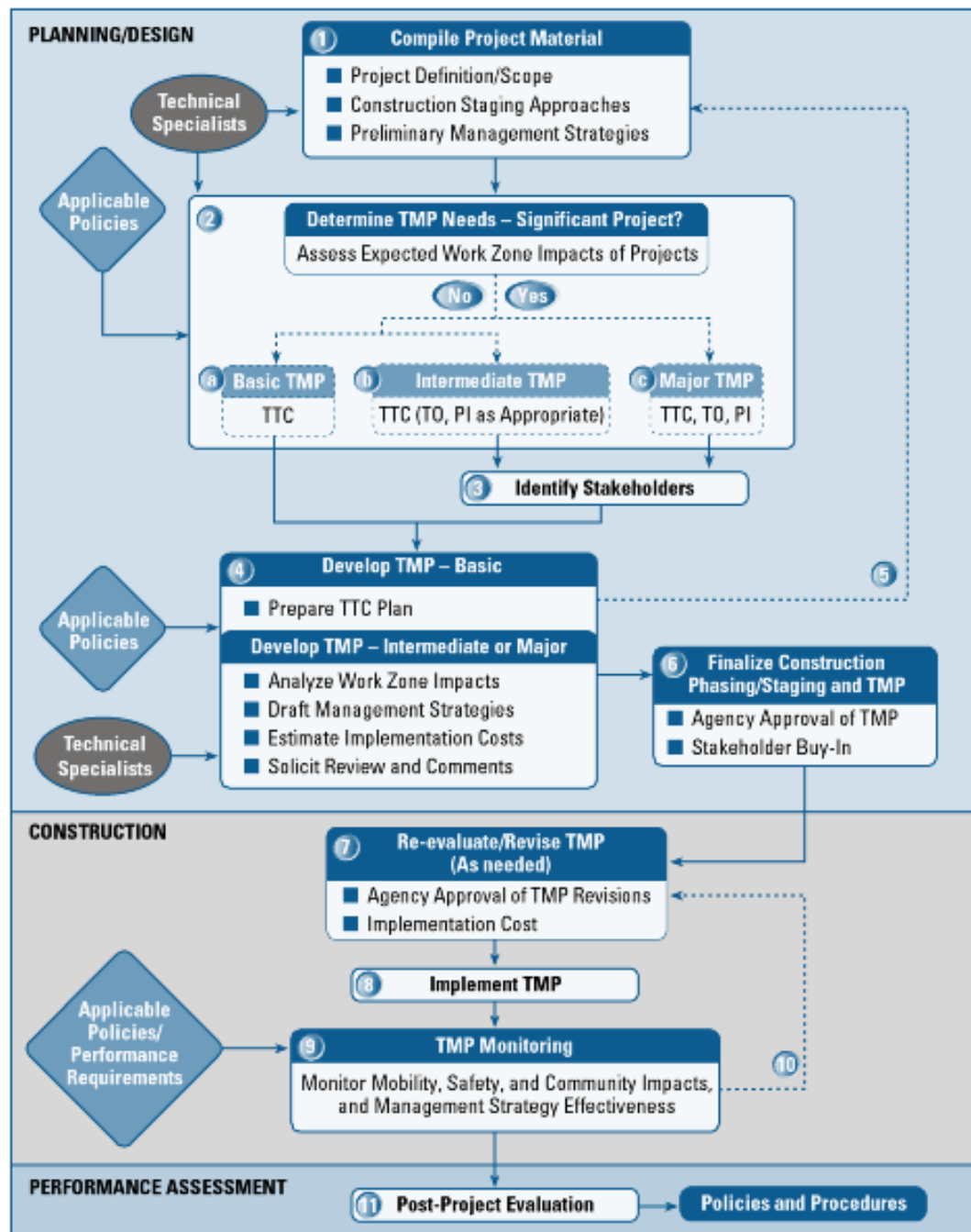

Source: FHWA Figure 6.1 Transportation Management Plans

## ~~B~~ BACKGROUND

~~Section 316.0745, Florida Statutes, mandates the Department of Transportation compile and publish a manual of traffic control devices for use on the streets and highways of the state. To comply with this statute, the Federal Highway Administration's (FHWA) Manual on Uniform Traffic Control Devices (MUTCD) has been adopted for use in Rule 14-15.010, Florida Administrative Code (F.A.C.).~~

~~MUTCD, Part 6.~~

## ~~C~~ OBJECTIVES

~~Managing through traffic and maintaining access during construction, maintenance and emergency response roadwork operations is necessary. The goal is to complete roadwork or resolve traffic incidents in a timely manner while minimizing traffic delays, maintaining access to travelers, and most importantly maintaining an acceptable level of safety. The general objective of a program of work zone safety is to protect workers, traffic incident responders, pedestrians, bicyclists, and motorists during roadwork operations. This general objective may be achieved by meeting the following specific objectives:~~

- ~~• Provide adequate advance warning and information about upcoming work zones~~
- ~~• Provide the pedestrians, bicyclists and motorists clear information to understand how to navigate through or around the work zone~~
- ~~• Reduce the consequences of an out-of-control vehicle~~
- ~~• Provide safe access and storage for equipment and material~~
- ~~• Promote the speedy completion of projects (including thorough cleanup of the site)~~
- ~~• Promote the use of the appropriate traffic control and protection devices~~
- ~~• Provide safe passageways for pedestrians through, in, and/or around construction or maintenance work zones~~

## ~~D~~ POLICY

~~Each agency with responsibilities for construction, maintenance, utility, or traffic incident management, or any roadwork operations on streets and highways shall develop and maintain a program of work zone safety, as set forth in the MUTCD, (Chapter 6A). Additional requirements related to all highway construction projects financed in whole or in part with federal aid highway funds are provided in Title 23 Code of Federal Regulations~~

~~(CFR) 630 Subpart J, more commonly known as the Work Zone Safety and Mobility Rule impose additional requirements for the design and construction of projects financed in whole or in part with federal aid highway funds.~~

## **DE TEMPORARY TRAFFIC CONTROL PLAN (TTCP) PLANNING OF ROADWORK OPERATIONS**

The achievement of work zone safety requires careful and complete planning prior to the initiation of any ~~read~~work. The planning objective is to develop a comprehensive Temporary Traffic Control Plan (TTCP) that includes the following considerations:

- Type of Operation
- Nature of Work Zone
- TTCP Details
- Work Scheduling
- Coordination

### **DE.1 Type of Operation Project Requirements**

#### **DE.1.a Type of Operation**

~~Readwork~~ The type of operations may be further classified as routine, unplanned, or planned operations.

##### **DE.1.a.1 Routine Operations**

Routine operations would involve projects such as mowing, street cleaning, and preventive maintenance operations conducted on a regularly scheduled basis.

##### **DE.1.a.2 Unplanned Operations**

Unplanned operations require prompt, efficient action to restore the ~~facility~~roadway to a safe condition. These include traffic incident management such as clearing vehicle crash or storm debris, addressing hazardous materials spills, repairing or replacing damaged ~~highway~~ safety components and restoring inoperative traffic control devices.

##### **DE.1.a.3 Planned Operations**

Planned operations are scheduled ~~readwork~~ projects, neither routine nor time-sensitive in nature, that are occasionally required to maintain or upgrade a street, ~~or~~ highway, sidewalk, or path.

## ~~DE.21.a~~ **DE.21.b** Nature of the Work Zone ~~Roadwork~~

The development of the ~~TTCP~~ temporary traffic control plan for work zone safety should include consideration of the following factors:

- Length of the project
- Duration and complexity of the work
- Hazards that may be created (e.g., long term drop-offs)
- ~~Time span required~~
- ~~Requirements for continuous operation or occupation of the work zone~~
- ~~Capability of clearing the site during cessation of work activity~~
- ~~The various construction methods, equipment, and procedures that may be utilized. Evaluation of alternate methods should be undertaken to determine the safest and most efficient procedures~~
- ~~The~~ Necessity for storing equipment or material in the facility ~~highway~~ right of way
- Traffic characteristics and patterns
- Effects on nearby businesses and residences, especially when detouring
- Site conditions that may be confusing or distracting
- Limitations on sight distance
- Decreased visibility associated with nighttime operations
- Reasonableness of detour length and complexity
- ~~—~~
- ~~Roadwork~~ Operations that may expose workers to hazards from through traffic
- ~~Hazards to pedestrians, bicyclists or out of control motorists~~ vehicles such as excavations or unguarded structures or equipment
- ~~Equipment inspection and preventive maintenance program~~
- ~~DE.31.c~~ Nature of the Work Zone Impacts

- ~~• The nature of the work zone and the prevailing traffic conditions should, to a large degree, influence the procedures incorporated into the TTCP plan for work zone safety. The development of the TTCP temporary traffic control plan should include consideration of the following factors:~~
- ~~• Location of the work zone in relation to the proximity to side streets, driveways, transit bus stops, schools, parks, places of worship, etc.~~
- ~~• Determination of the type of traffic affected, design vehicle, normal vehicle travelling speed, and existing traffic volumes.~~
- ~~• Distribution of traffic with respect to peak traffic periods (seasonal, day of week, time of day, etc.)~~
- ~~• Truck percentage, frequency of transit vehicles, unique characteristics of pedestrians and bicyclists who commonly travel the corridor (e.g. school children), and direction of traffic is also important for establishing traffic control procedures.~~
- ~~• Presence of Intelligent Transportation Systems (ITS) such as dynamic message boards.~~
- ~~• Site conditions that may be confusing or distracting to the motorist, pedestrian, or bicyclist.~~
- ~~• Limitations on sight distance.~~
- ~~• Decreased visibility associated with nighttime roadwork operations.~~
- ~~• Impacts of detours and diversions to businesses, and residential communities, schools, parks, community services.~~
- ~~• Pedestrian and bicycle accommodations.~~
- ~~• Reasonableness of detour length and complexity.~~

### **D.3 TTCP Details**

Plans should include protection at work zones when work is in progress and when operations have been halted (such as during the night, special events or restrictions, holidays). The TTCP should include provisions for the following:

- Work zone traffic signs
- Channelizing devices
- Temporary barriers (see **Chapter 4 – Roadside Design**)
- The usage of flaggers or temporary traffic signals
- Access and accommodations for pedestrians, bicyclists, and transit users
- Lane widths (see **Section D.6 Number and Width of Travel Lanes, Bike Lanes, Sidewalks, and Shared Use Paths**)
- Drop-off hazards (-see **Chapter 4 – Roadside Design**)
- Above ground hazards (see **Chapter 4 – Roadside Design**)
- Clear zone (see **Chapter 4 – Roadside Design**)
- Sight distance (intersection, stopping)
- Temporary drainage
- Work zone speed
- Lane closure restrictions
- Bus stops, boarding and alighting areas, shelters, lighting
- Traffic control officers and law enforcement
- Adequate work zone space for construction vehicles, workers -and materials
- Night safety (see **Chapter 6 – Lighting**)
- Traffic control and protective devices – including short term transverse rumble strips and temporary raised rumble strip sets (see **Section D.3.1 Short Term Transverse Rumble Strips, Section, D.3.2 Temporary Raised Rumble Strip Sets, and Chapter 18 – Signing and Marking**)
- Detours, including for pedestrians and bicyclists
- Special events

### **D.3.a Short Term Transverse Rumble Strips**

In locations with existing raised rumble strip sets (e.g., intersections, approaches to horizontal curves, toll plazas), maintain or replace the raised rumble strip sets throughout construction. Provide short-term raised rumble strip sets when existing raised rumble strip sets are removed for construction activities, until the permanent raised rumble strip sets are installed. Short-term raised rumble strip sets must be installed prior to opening the road to traffic; therefore, quantities may include multiple applications due to construction phasing. The [FDOT's Standard Plans, Index 546-001](#) and [Standard Specifications, Section 546](#) provide additional information on short term raised rumble strips.

### **Example of Transverse Rumble Strips**



### **D.3.b Temporary Raised Rumble Strip Sets**

Temporary raised rumble strip sets are used to warn vehicular traffic of the upcoming work zone. They may be used to supplement the required signs,



channelizing devices, and flagging operations in the work zone. They are most often used when both of the following conditions occur:

- Lane closure on a two-lane, two-way roadway
- Existing posted speed prior to construction is 55 mph or greater

The FDOT's [Standard Plans, Index 102-603](#) provide additional information on temporary raised rumble strips.

## **DE.42** Work Scheduling

Proper work scheduling and sequencing of ~~roadwork~~ operations will ~~not only~~ promote efficiency, but also improve the safety aspects. Where feasible, routine operations and special projects should be conducted during periods of low traffic volume to reduce conflicts. Projects that may be carried out concurrently at the same site should be scheduled simultaneously to eliminate successive disruptions of traffic.

Major projects that impede or restrict traffic flow should be coordinated and sequenced with similar projects in adjacent areas, to produce a minimum of disruption to orderly traffic flow in the overall ~~highway~~ network. The scheduling of work at a given location should include consideration of traffic generation (including special events), as well as traffic restrictions by work activities on the surrounding ~~highway~~ network.

### DE.53 ~~Traffic Control and Protection~~

~~Plans for traffic control around or through work zones should be developed with safety receiving a high priority. Plans should include protection at work zones when work is in progress and when operations have been halted (such as during the night). Provisions for the protection of work crews, traffic control personnel, bicyclists, pedestrians, (in areas of high pedestrian use, construction of temporary facilities should be considered), and motorists shall be included in the operation plans. The plan for traffic control and protection should consider provisions for the following:~~

Clear view of work zone

Advance warning devices

~~Work zone traffic signs~~

~~Channelizing devices~~

~~Clear view of work zone~~

~~Roadway, sidewalk and shared use path delineation and channeling devices~~

~~Transit Stops – including passenger access~~

~~Clear zone (*Chapter 4 – Roadside Design*)~~

~~Regulatory information~~

~~High-visibility safety apparel for workers~~

~~Traffic control officers and law enforcement~~

~~Hazard warning~~

~~Barriers~~

~~Pedestrian and bicyclist safety~~

~~Access for pedestrians, bicyclists, and motor vehicles~~

~~Access to adjacent properties by the public during construction~~

~~Location of construction vehicles and equipment, including access into and out of the work zone~~

~~Night safety (*Chapter 6 – Lighting*)~~

~~Personnel training~~

~~Traffic control and protective devices – including transverse rumble strips (*Chapter*~~

## 18— Signing and Marking

~~Transit Stops—including passenger access~~

~~Abrupt changes in geometry (lane narrowing, lane drop, transitions)~~

~~Turning restrictions~~

- ~~• Temporary traffic signals~~

### **DE.564** Coordination with Others

To ensure safe and efficient roadwork operations, the ~~temporary traffic control plan~~ **TTCP** should be developed and executed in cooperation with interested individuals and agencies, which may include the following:

- ~~Transportation~~ **Highway** agencies
- Police ~~and sheriff's departments~~ agencies
- Emergency ~~responders~~ agencies
- Contractors
- Utilities
- Building departments
- Mass transit ~~providers~~ agencies
- Traffic generators
- ~~Local~~ **R**esidents and businesses
- Neighboring jurisdictions
- School Boards
- Postal Services
- Media
- ~~Trash~~ and recycling pick ups

## **D.6 Number and Width of Travel Lanes, Bike Lanes, Sidewalks, and Shared Use Paths**

The number and width of travel lanes, sidewalks, shared use paths, and bike lanes should be maintained through work zones. The minimum widths for work zone travel lanes, sidewalks, shared use paths, and bike lanes shall be as follows:

- Freeways – 11 feet
- Arterials – 10 feet except on transit or truck routes, where a minimum width outside through lane of 10.5 feet is required
- Collectors – 10 feet
- Local – 10 feet, or to match existing lane widths if less than 10 feet
- Sidewalks – 5 feet
- Shared Use Paths – 8 feet
- Bike Lanes – 4 feet plus 1' offset from barrier or curb

Do not allow traffic control and warning devices to encroach on travel lanes, bike lanes, paved shoulders, sidewalks, and shared use paths open for travel.

## **D.7 Clear Zones, Above-Ground Hazards, Drop-Offs, and Temporary Barriers**

When above-ground hazards or drop-offs occur within the clear zone or adjacent to pedestrian facilities due to construction or maintenance activities, protection devices may be needed. See **Chapter 4 – Roadside Design** for requirements.

~~A drop-off is defined as a drop in elevation, parallel to the adjacent travel lanes, greater than 3" with slope (A:B) greater than 1:4. In superelevated sections, the algebraic difference in slopes should not exceed 0.25. See Figure 11—21xx Drop-off Condition Detail, Table 11—1 Drop-off Protection Requirements and Table 11—2 Clear Zone Widths for Work Zones for further requirements. A setback distance appropriate for the type of barrier selected shall be provided. For further information on setback requirements for various types of barriers, see can be found in **FDOT's Standard Plans, Index 102-100.**~~

For Conditions 1 and 3 provided in Table 11—1xx Drop-off Protection Requirements, any drop-off condition that is created and restored within the

same work period will not be subject to the use of temporary barriers. However, channelizing devices will be required, unless existing permanent curb heights are  $\geq 6"$ . For curb heights  $< 6"$ , see Table 11—1 Drop-off Protection Requirements.

Drop-offs may be mitigated by placing slopes of optional base material. See the *FDOT Department's Standard Specifications, Section 285* for further information. Slopes shallower than 1:4 may be required to avoid an algebraic difference in slopes greater than 0.25.

Protect any drop-off adjacent to a pedestrian facility with pedestrian longitudinal channelizing devices, temporary barrier wall, or approved handrail. Adjacent to pedestrian facilities, a drop-off is defined as:

— a drop in elevation greater than 10" that is closer than 2 feet from the edge of the sidewalk or shared use path, or

— a slope steeper than 1:2 that begins closer than 2 feet from the edge of the sidewalk or shared use path when the total drop-off is greater than 60".

— Figure 11—21xx Drop-Off Detail

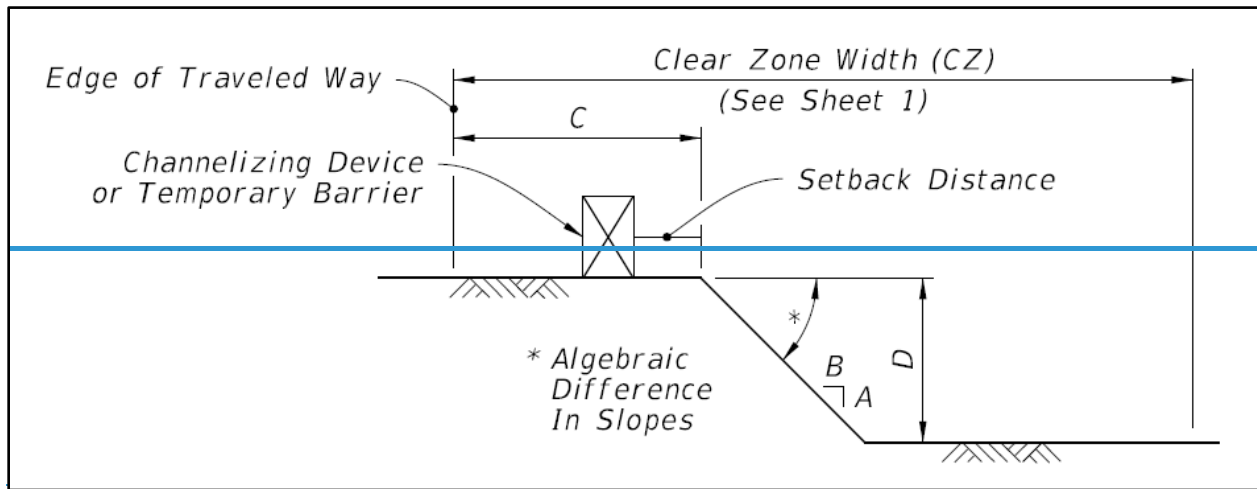

**Table 11 – 1x Drop-off Protection Requirements**

<u>Condition</u>	<u>D (inches)</u>	<u>C (feet)</u>	<u>Device Required</u>
<u>1</u>	<u>&gt; 3</u>	<u>2 – 12</u>	<u>Temporary Barrier</u>
<u>2</u>	<u>&gt; 3 to ≤ 5</u>	<u>12 – CZ</u>	<u>Channelizing Device</u>
<u>3</u>	<u>&gt; 5</u>	<u>2 – CZ</u>	<u>Temporary Barrier</u>
<u>4</u>	<u>Removal of Bridge or Retaining Wall Barrier</u>		<u>Temporary Barrier</u>
<u>5</u>	<u>Removal of Portions of Bridge Deck</u>		<u>Temporary Barrier</u>

Notes:

- Do not allow any drop-off conditions greater than 3 inches within two feet of the edge of traveled way.
- See Table 114 – 21 Clear Zone Widths for Work Zones Minimum Width of Clear Zone in Chapter 4 – Roadside Design for Clear Zone (CZ) values.

~~The table below gives clear zone widths in work zones for medians and roadside conditions other than for roadside canals. Where roadside canals are present, clear zone widths are to conform with the lateral offset distances to canals described in Chapter 4 – Roadside Design.~~

## **D.8 Work Affecting Pedestrian and Bicycle Facilities**

### **D.8.a Pedestrian Facilities**

When an accessible sidewalk or shared use path is temporarily closed to pedestrians by construction, alterations, maintenance operations, or other conditions, an alternate pedestrian access route complying with Sections 6D.01, 6D.02, and 6G.05 of the **MUTCD** shall be provided. Where provided, pedestrian barricades and channelizing devices shall comply with sections 6F.63, 6F.68, and 6F.71 of the **MUTCD**. The temporary sidewalk or shared use paths shall maintain the same level of accessibility as the existing facility or greater. Minimize diversions and detour lengths.

For a temporary sidewalk, provide a minimum width of 5 feet. In constrained conditions, a minimum sidewalk width of 4 feet may be provided, with a 5' x 5' passing section at least every 200 feet. For a temporary shared use path, provide a minimum width of 8 feet. Both sidewalks and shared use paths shall have a maximum cross slope of 0.02 and running slope of 5%. If the temporary sidewalk or shared use path is contained within a street or highway right of way the maximum running slope shall not exceed the general grade established for the adjacent street or highway.

When temporary sidewalks or shared use paths intersect with streets or driveways, ensure that all curb ramps or blended transitions meet ADA requirements. Detectable warnings shall be provided at intersections with all streets and signalized or stop sign **traffic** controlled driveways. Detectable warnings are not required for curb ramps or blended transitions diverting pedestrian traffic into a closed lane.

See **Chapter 8 – Pedestrian Facilities** and **Chapter 9 – Bicycle Facilities** for further information. Additional information on designing accessible sidewalks and shared use paths can be found on the **United States Access Board's** web page for **Streets and Sidewalks**, including the **(Proposed) Public Rights-of-Way Supplemental Notice of Proposed Rulemaking, Accessibility Guidelines (PROWAG)** for Pedestrian Facilities in the Public Rights of Way; Shared Use Paths.

### **D.8.b Bicycle Facilities**

The continuity of a bicycle facility should be maintained through the work zone. Continuity through the work zone is particularly important where bicyclists have been traveling on a shoulder, bike lane, or shared-use path



prior to the work zone and adjacent to a lane having a posted speed limit  $\geq$  35 miles per hour. If a bicycle lane, paved shoulder, or shared use path on a roadway having a speed limit of 35 mph or higher is closed a separate bicycle facility or detour route should be provided. To maintain room for bicycle lanes, paved shoulders, or a shared use path through the work zone on a multi-lane roadway, one or more travel lanes could be closed.

On roadways where bicyclists currently share lanes with motor vehicle traffic, the TTCF and typical applications for general traffic will usually be adequate for bicyclists as well.

If a bicycle facility detour is unavoidable, it should be as short and direct as practical, using roadways where conditions are appropriate for bicycling. On-road bicyclists should not be directed onto a sidewalk unless no practical alternative is available (such as might be the case on a bridge in the course of a rehabilitation project or roadway with environmental or right of way constraints). If directing cyclists onto a sidewalk, sidewalks should be widened to be at least 6 feet, 7 feet when back of curb.

If a portion of a bicycle facility is to be closed due to construction activities and the detoured facility follows a complex path not in the original corridor, then a full detour plan should be developed and implemented. The TTCF for the detour of the bicycle facility should include all necessary advance warning (W21 series) signs, detour (W4-9 series) signs, and any other TTCF devices necessary to guide bicyclists along the detour route.

If an on-street bicycle facility had a wide outside through travel lane (lanes having a width of at least 14 feet) prior to construction, and construction activities reduce the lane width to less than 14 feet through the work zone, then the Bicycles May Use Full Lane (R4-11) sign and Shared Lane Marking should be used.

Additional requirements for providing for and managing bicycle travel in work zones is found in **Part 6 of the MUTCD**. The minimum TTC sign and plaque sizes for shared-use paths shall conform to those shown in **Table 9B-1 Bicycle Facility Sign and Plaque Minimum Sizes of the MUTCD**. The minimum TTC sign and plaque sizes for on-street bicycle facilities shall conform to **Chapter 6F of the MUTCD**.

## **D.9 Typical Application Examples**

The following figures provide examples of typical applications. Typical applications should be used to develop a site-specific TTCP. Examples are provided for the following scenarios:

Figure 11 – 2 Two-Lane Roadway Lane (Closure Using Flaggers)

Figure 11 – 3 Multi-Lane Roadway Lane (Single Lane Closure)

Figure 11 – 4 Sidewalk/Shared Use Path Diversion (Temporary Sidewalk/Shared Use Path)

Figure 11 – 5 Sidewalk/Shared Use Path Detour (Closure with Reroute)

Figure 11 – 6 Bicycle Lane Closure Without Detour

Figure 11 – 7 Bicycle Lane Closure With On-Road Detour

Figure 11 – 8 Shared Use Path Closure with a Diversion

Figure 11 – 9 On-Road Detour for Shared Use Path

Figure 11 – 10 Paved Shoulder Closure with Bicycle Diversion onto Temporary Path

The recommended spacing for work zone details in the Figures below are provided in Tables 11 – 1 Work Zone Sign Spacing “X”, Table 11 – 2 Taper Length “L”, Table 11 – 3 Buffer Length “U”, and Table 11 – 4 Channelizing Device Spacing. The **MUTCD** provides additional information; for work zone sign spacing see **Table 6H-3**; for taper length see **Table 6H-4**, and for buffer length, see **Table 6C-2**. Provide pavement markings in accordance with **Section 6F-78** of the **MUTCD**. The FDOT’s **The DepartStandard Plans, 102 Series** provides additional information and modifications of typical applications found in the **MUTCD**. ~~Most work zones will require further development of the typical applications to address project specific conditions. For work zone sign spacing, see Table 6H-3; for taper length see Table 6H-4, and for buffer length, see Table 6C-2 of the MUTCD. Provide 6” white lines in accordance with Section 6F-78 of the MUTCD.~~

**Table 11 – 1 Work Zone Sign Spacing “X”**

<u>Road Type</u>	<u>Min. Spacing (feet)</u>
<u>Arterials and collectors with Work Zone Speed ≤ 40 mph</u>	<u>200</u>
<u>Arterials and collectors with Work Zone Speed ≥ 45 mph</u>	<u>500</u>
<u>Freeways/Limited Access Roadways</u>	<u>1,500</u>

**Table 11 – 2 Taper Length “L”**

<u>Work Zone Speed (mph)</u>	<u>Min. Length (feet)</u>
<u>≤ 40</u>	<u><math>L = WS^2/60</math></u>
<u>≥ 45</u>	<u><math>L = WS</math></u>
<u>Note-: Where W = width of offset in feet</u> <u>S = speed in mph</u>	

**Table 11 – 3 Buffer Length “U”**

<u>Work Zone Speed (mph)</u>	<u>Min. Length (feet)</u>
<u>25</u>	<u>155</u>
<u>30</u>	<u>200</u>
<u>35</u>	<u>250</u>
<u>40</u>	<u>305</u>
<u>45</u>	<u>360</u>
<u>50</u>	<u>425</u>
<u>55</u>	<u>495</u>
<u>60</u>	<u>570</u>
<u>65</u>	<u>645</u>
<u>70</u>	<u>730</u>
<u>Note: When Buffer Length “U” cannot be attained due to geometric constraints, use the greatest length possible, but not less than 155 feet.</u>	

**Table 11 – 4 Channelizing Device Spacing**

<u>Speed (mph)</u>	<u>Max. Distance Between Devices (feet)</u>			
	<u>Tubular Markers</u>		<u>Vertical Panels or Opposing Traffic Lane Divider</u>	
	<u>Taper</u>	<u>Tangent</u>	<u>Taper</u>	<u>Tangent</u>
<u>25</u>	<u>25</u>	<u>50</u>	<u>25</u>	<u>50</u>
<u>30 to 45</u>	<u>25</u>	<u>50</u>	<u>30</u>	<u>50</u>
<u>50 to 70</u>	<u>25</u>	<u>50</u>	<u>50</u>	<u>100</u>

~~For a temporary sidewalk, provide a minimum width of 5 feet. In constrained conditions, a minimum sidewalk width of 4 feet may be provided, with a 5' x 5' passing section at least every 200 feet. For a temporary shared use path, provide a minimum width of 8 feet. Both sidewalks and shared use paths shall have a maximum cross slope of 0.02 and running slope of 5%. If the temporary sidewalk or shared use path is contained within a street or highway right of way the maximum running slope shall not exceed the general grade established for the adjacent street or highway.~~

~~When temporary sidewalks or shared use paths intersect with streets or driveways, ensure that all curb ramps or blended transitions meet ADA requirements. Detectable warnings shall be provided at intersections with all streets and signalized or stop sign traffic controlled driveways. Detectable warnings are not required for curb ramps or blended transitions diverting pedestrian traffic into a closed lane. Additional information on designing accessible sidewalks and shared use paths can be found on the [United States Access Board's](#) web page for [Streets and Sidewalks](#), including the Supplemental Notice of Proposed Rulemaking, Accessibility Guidelines for Pedestrian Facilities in the Public Rights of Way; Shared Use Paths.~~

**Figure 11 – 2 — Two-Lane Roadway, Single Lane Closure Using Flaggers**

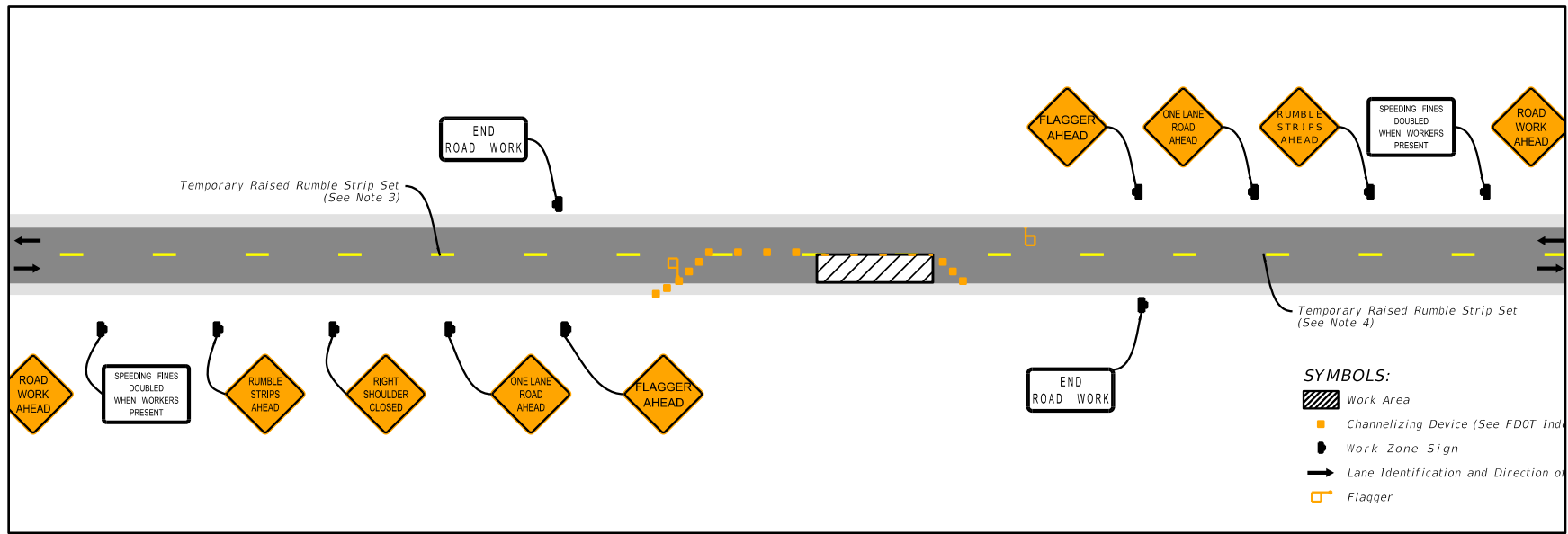

**Notes:**

1. X = Work Zone Sign Spacing, L = Taper Length, U = Buffer Length, see Table 11 – 1, 11 – 2, and 11 – 3 of this chapter and the MUTCD.
2. See Table 11 – 4 for the required spacing of channelizing devices.
3. If temporary rumble strips are used, include “Rumble Strips Ahead” signs and associated sign spacing distance.
4. “Speeding Fines Doubled When Workers Present” signs may be used,
5. “End Road Work” signs may be included when the work zone is in place for greater than 24 hours.
6. Temporary Pavement Markings are required for work zones greater than 24 hours in duration.
7. For general sign codes refer to FHWA Standards for Highway Signs and Markings. For special signs beginning with MOT-xx, FDOT’s Special Sign Details in the **Standard Plans** provide additional information.

**Figure 11 – 3 — Multi-Lane Roadway, Single Lane Closure**

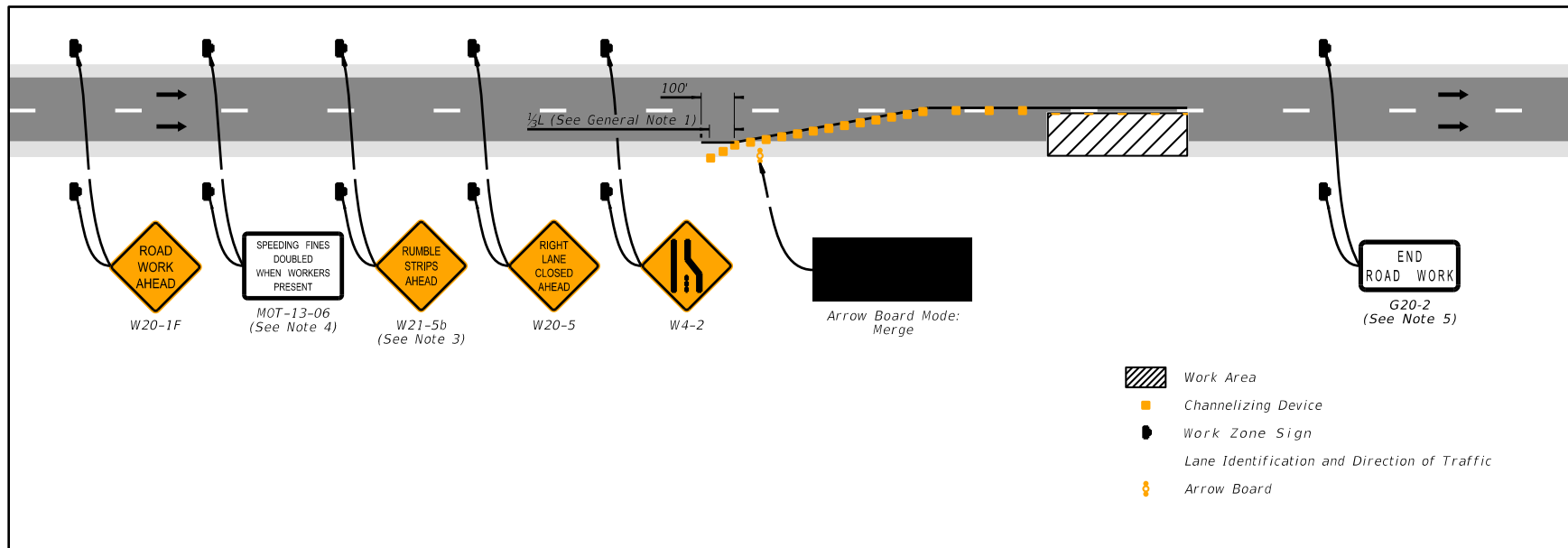

**Notes:**

1.  $X$  = Work Zone Sign Spacing,  $L$  = Taper Length,  $U$  = Buffer Length, see Table 11 – 1, 11 – 2, and 11 – 3 of this chapter and the MUTCD.
2. See Table 11 – 4 for the required spacing of channelizing devices.
3. If temporary rumble strips are used, include “Rumble Strips Ahead” signs and associated sign spacing distance.
4. “Speeding Fines Doubled When Workers Present” signs may be used.
5. “End Road Work” signs may be included when the work zone is in place for greater than 24 hours
6. Temporary Pavement Markings are required for work zones greater than 24 hours in duration.
7. For general sign codes refer to FHWA Standards for Highway Signs and Markings. For special signs beginning with MOT-xx, FDOT’s Special Sign Details in the Standard Plans provide additional information.

**Figure 11 – 4 Sidewalk/Shared Use Path Diversion (Temporary Sidewalk/Shared Use Path)**

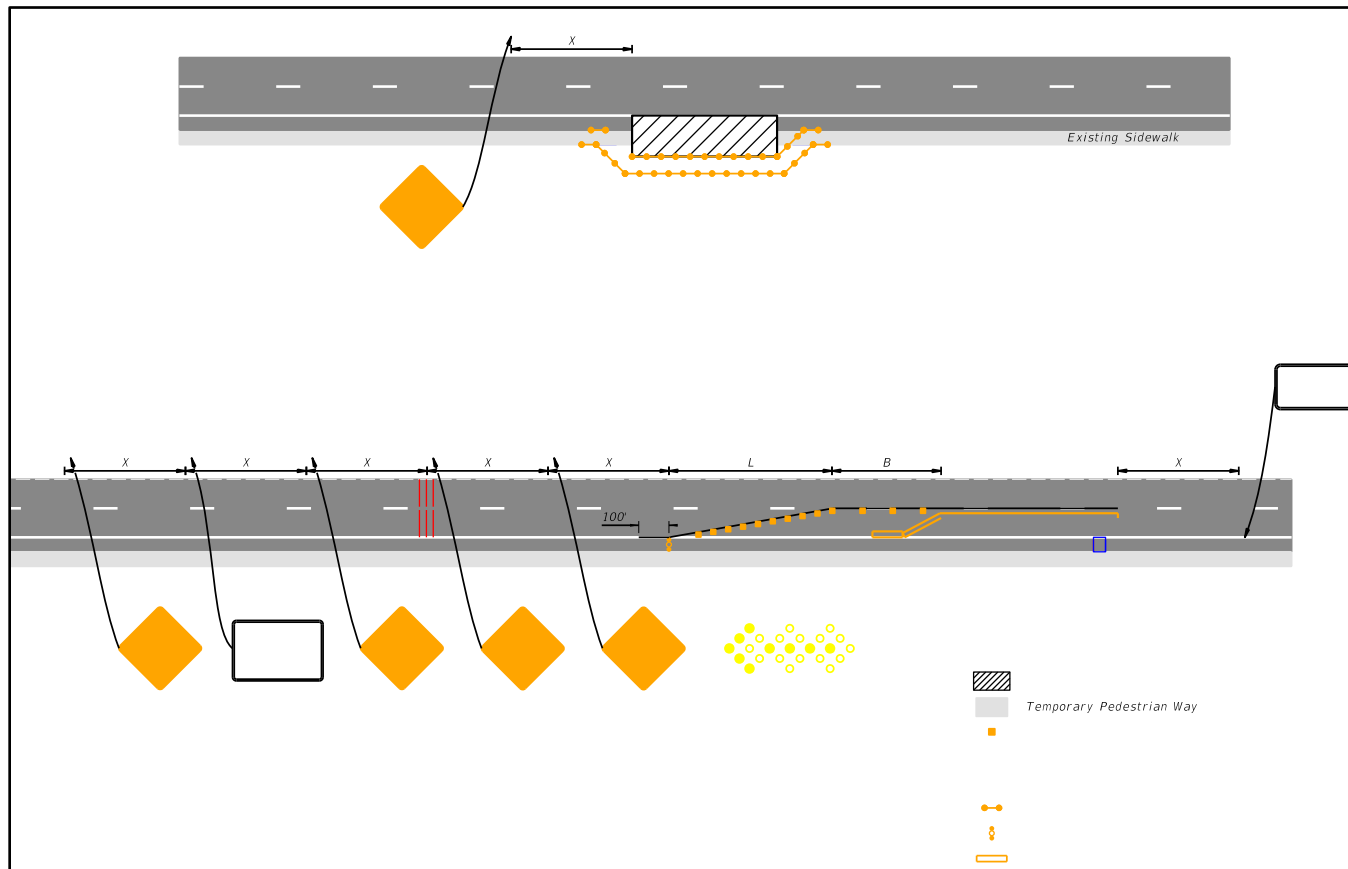

Notes: See following page.



1. X = Work Zone Sign Spacing, L = Taper Length, U = Buffer Length, see Table 11 – 1, 11 – 2, and 11 – 3 of this chapter and the MUTCD.
2. See Table 11 – 4 for the required spacing of channelizing devices.
- ~~4.~~3. Temporary sidewalks and shared use paths shall have a maximum cross-slope of .02. Provide curb ramps or blended transitions with detectable warnings.
- ~~2.~~4. If temporary rumble strips are used, include “Rumble Strips Ahead” signs and associated sign spacing distance.
- ~~3.~~5. “Speeding Fines Doubled When Workers Present” signs may be used.
- ~~4.~~6. “End Road Work” signs may be included when the work zone is in place for greater than 24 hours.
- ~~5.~~7. Temporary Pavement Markings are required for work zones greater than 24 hours in duration.
8. For general sign codes refer to FHWA Standards for Highway Signs and Markings. For special signs beginning with MOT-xx, FDOT’s Special Sign Details in the **Standard Plans** provide additional information.

**Figure 11 – 5 Sidewalk/Shared Use Path Detour (Closure with Reroute)**

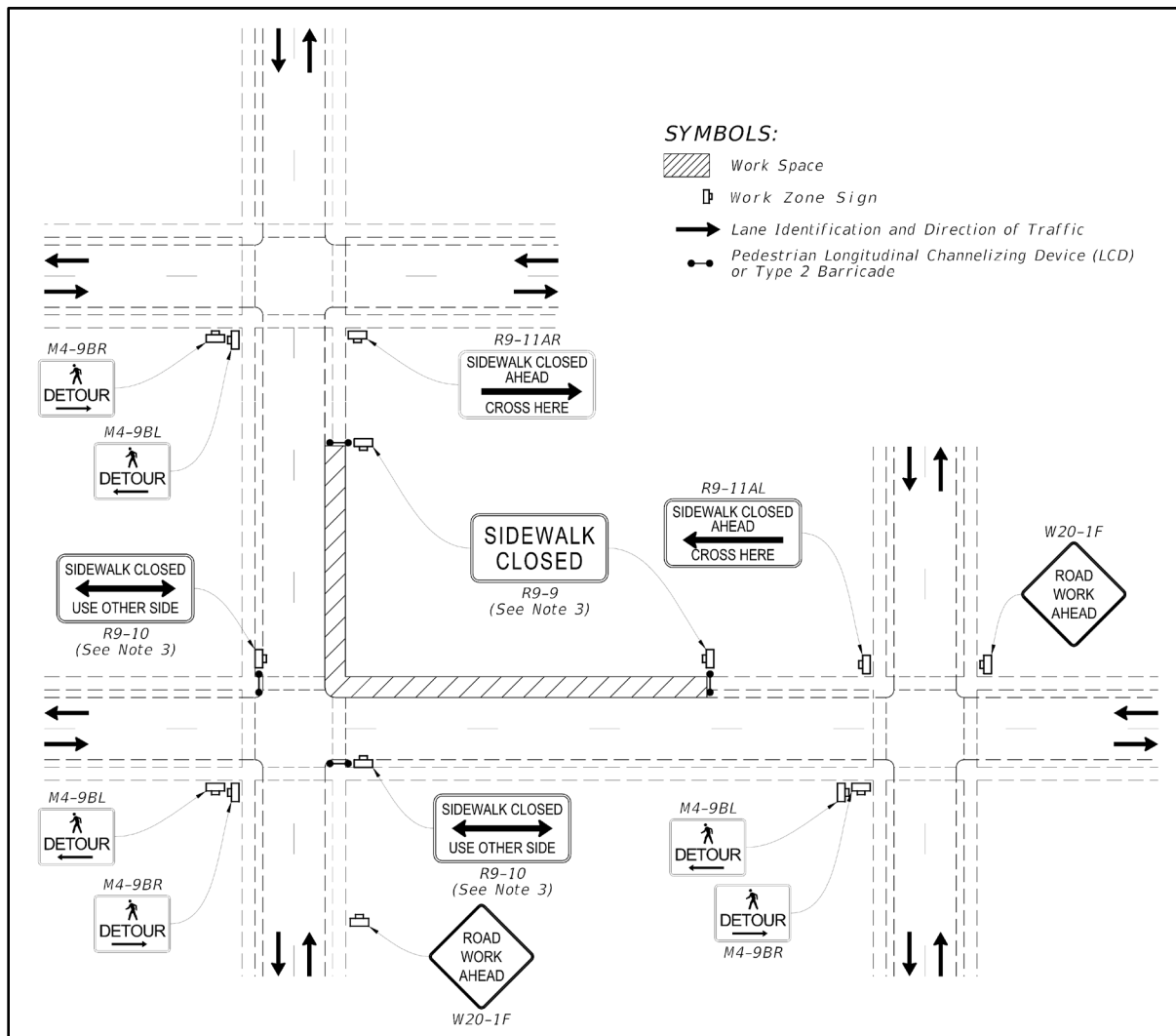

**Notes:**

1. Cover or deactivate pedestrian traffic signal display(s) controlling closed crosswalks.
2. Place pedestrian longitudinal channelizing devices (LCD) across the full width of the closed crosswalk.
3. "Sidewalk Closed" signs (R9-xx) may be mounted on pedestrian LCDs in accordance with the manufacturer's instructions.

**Figure 11 – 6** ———— **Bicycle Lane Closure Without Detour**

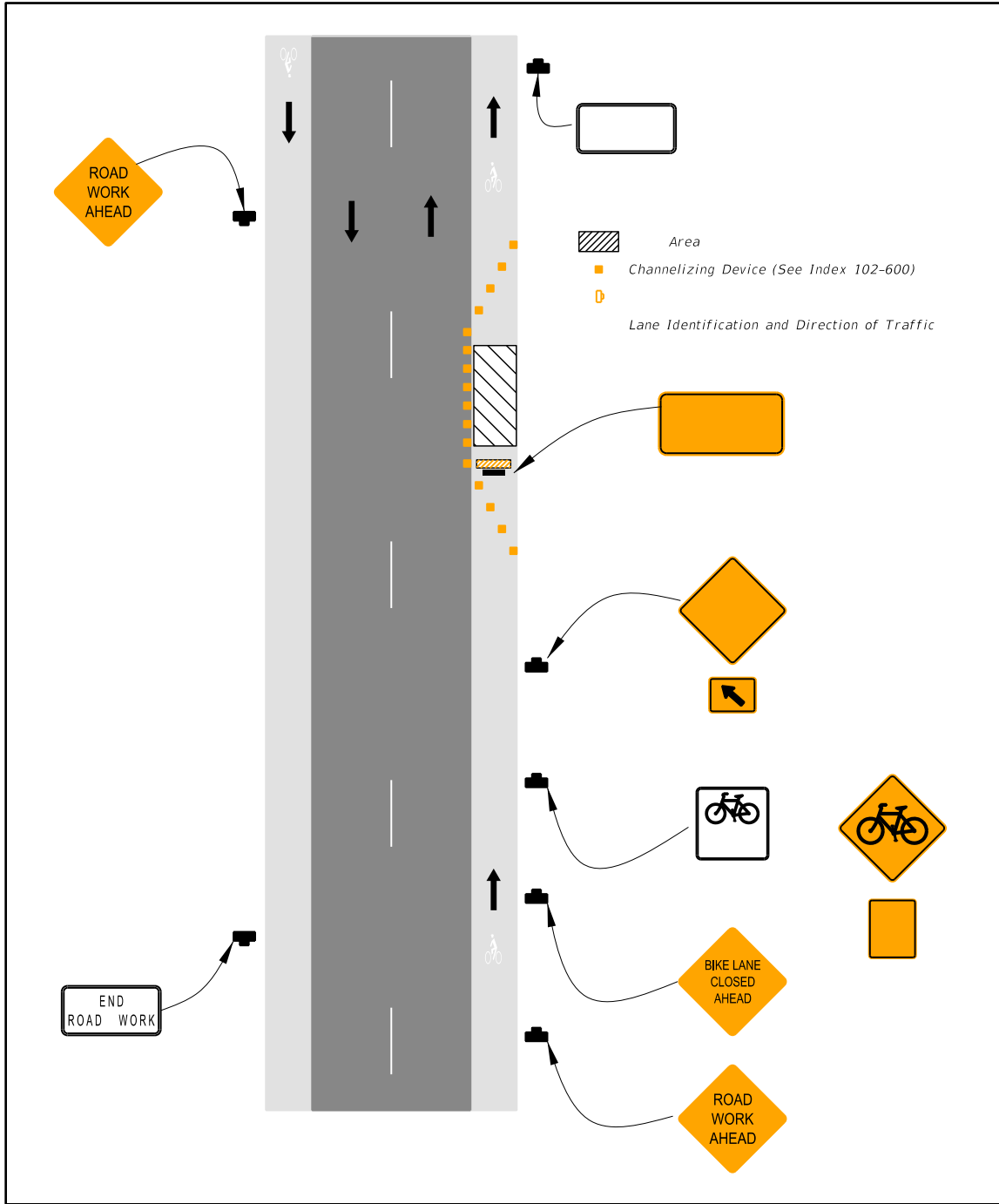

Notes: [See following page.](#)

1. See Table 6H-3 Meaning of Letter Codes of the MUTCD for the distances A, B and C between signs.
2. See Table 6-H-4 Formulas of the MUTCD for Determining Taper Length for the distance L. Speeds shall be posted speeds.
3. See Table 11 – 4 for the required spacing of channelizing devices.
4. If the posted speed limit is  $\leq$  35 mph, and the outside through travel lane is  $<$  14 feet wide, then Bicycles May Use Full Lane (R4-11) signs should be used.
5. If the posted speed limit is  $\leq$  35 mph, and the outside through travel lane is  $\geq$  14 feet wide throughout the work zone, then Bicycle Warning (W11-1) signs in association with SHARE THE ROAD (W16-1) plaques should be used.

**Figure 11 – 7** ———— **Bicycle Lane Closure with On-Road Detour**

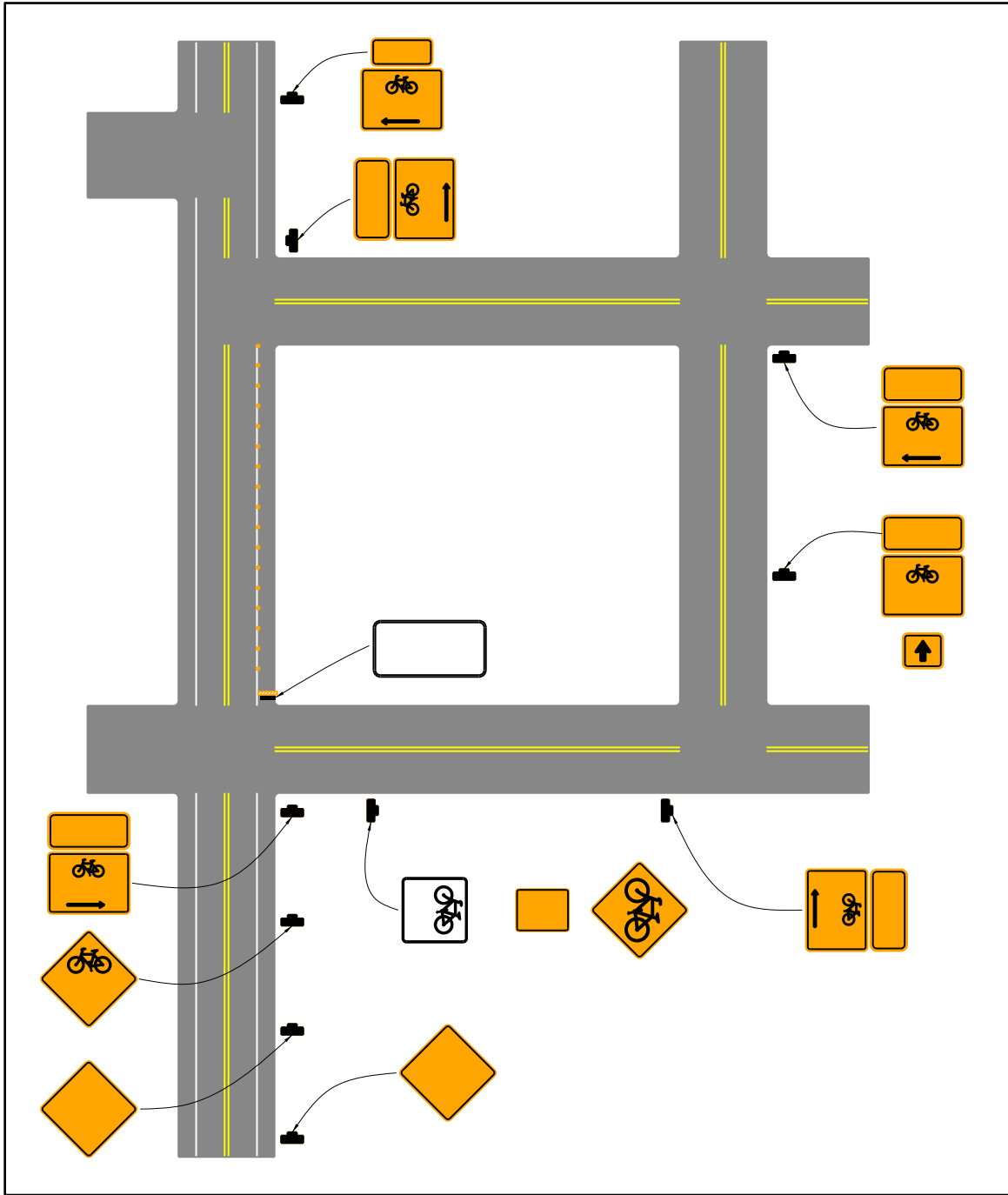

Notes: See following page.

1. See Table 6H-3 Meaning of Letter Codes of the MUTCD for the distances A, B and C between signs.
2. If the posted speed limit is  $\leq 40$  mph, and the outside through travel lane is  $< 14$  feet wide, then Bicycles May Use Full Lane (R4-11) signs should be used.
3. See Table 11 – 4 for the required spacing of channelizing devices.
4. If the posted speed limit is  $\leq 40$  mph, and the outside through travel lane is  $\geq 14$  feet wide throughout the work zone, then Bicycle Warning (W11-1) signs in association with SHARE THE ROAD (W16-1) plaques should be used.
5. A Street Name sign or Bike Route Name sign should be mounted with the Bike Detour sign. Where used, the Street Name sign or Bike Route Name sign shall be placed above the Bike Detour sign. The Street Name sign or Bike Route Name sign may be either white on green or black on orange.

**Figure 11 – 8** Shared Use Path Closure with a Diversion

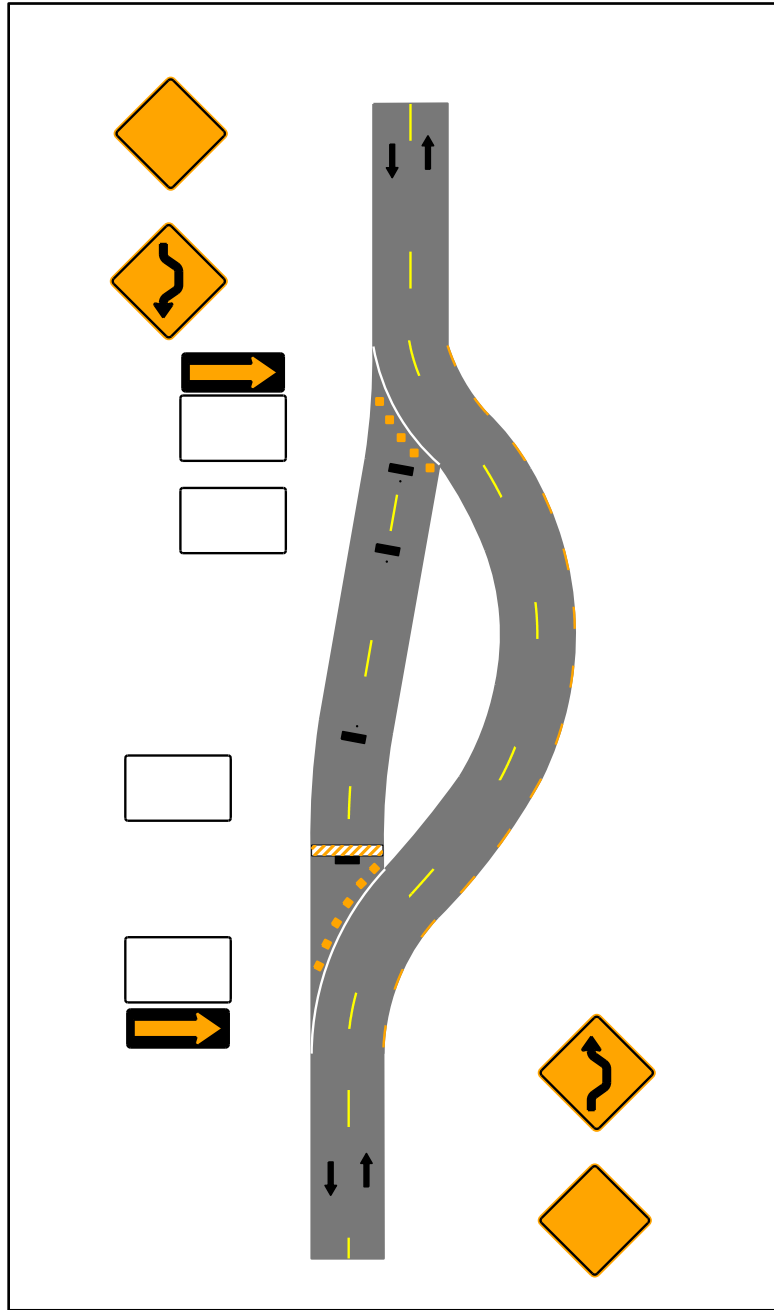

**Notes:**

1. See MUTCD Table 6H-2 Meaning of Symbols on Typical Application Diagrams.
2. See Table 11 – 4 for the required spacing of channelizing devices.





**Figure 11 – 9** On-Road Detour for Shared Use Path

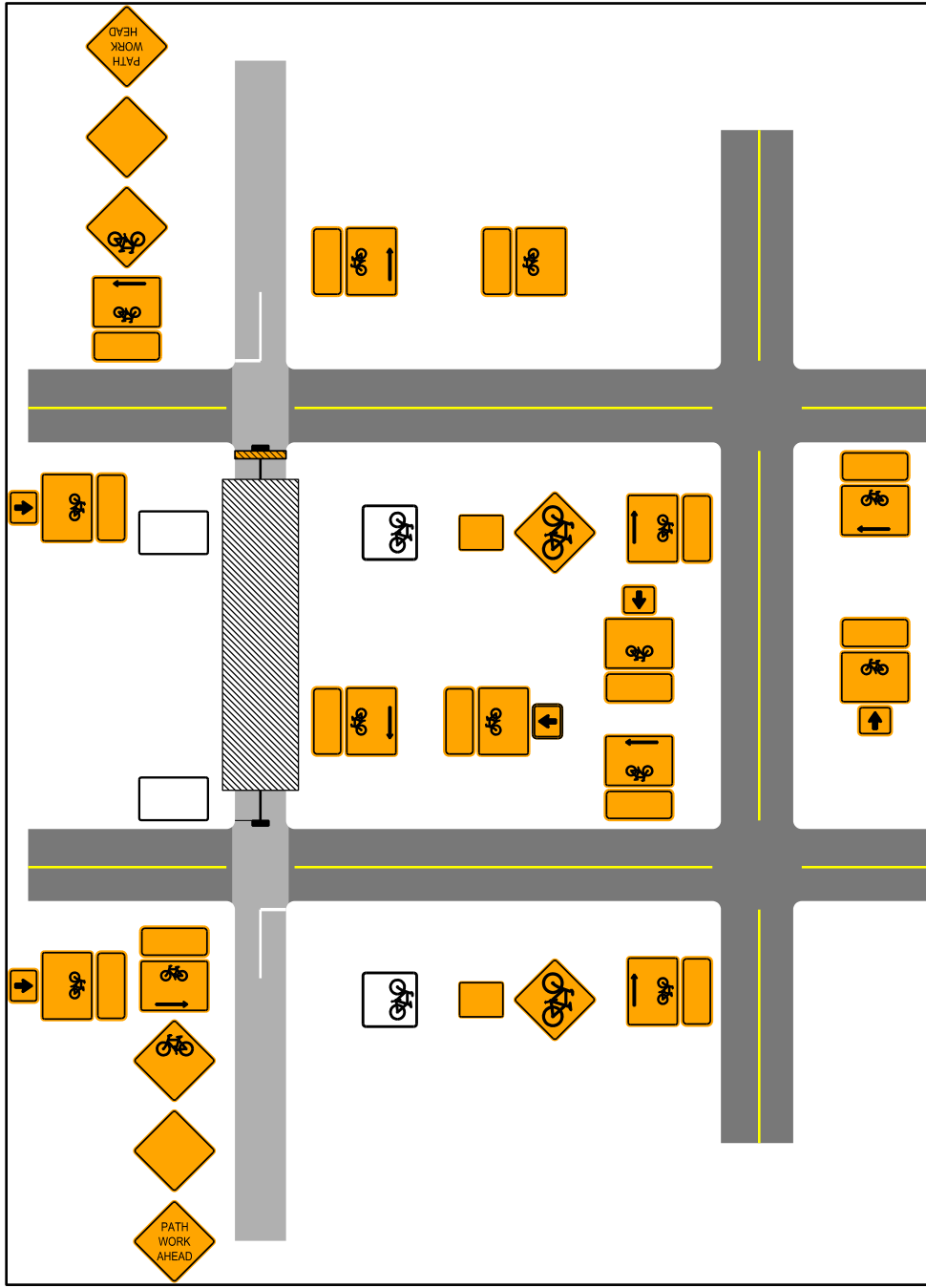

**Notes:**

1. See MUTCD Table 6H-2 and 6H-3 for the meaning of the symbols and letter codes used.

**Figure 11 – 10** Paved Shoulder Closure with Bicycle Diversion onto Temporary Path

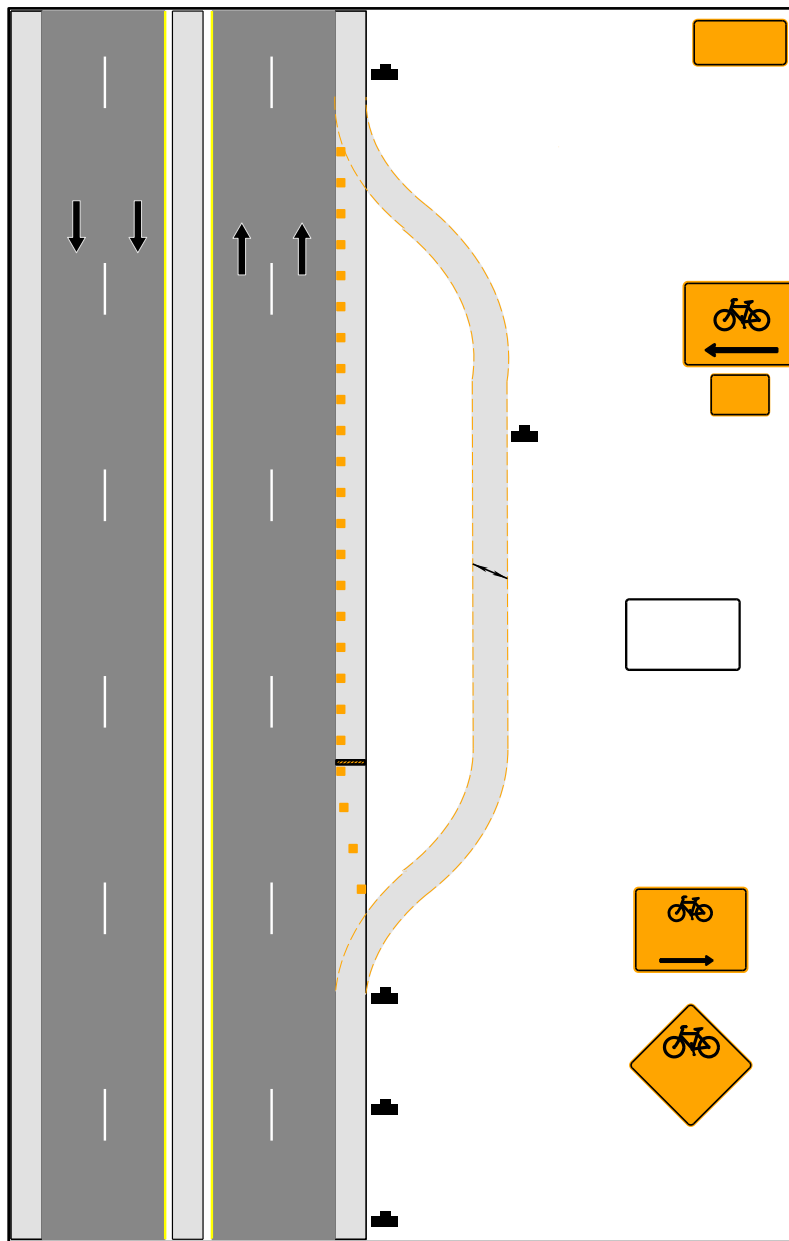

**Notes:**

1. See Table 6H-3 Meaning of Letter Codes of the MUTCD for the distances A, B and C between signs.
2. See Table 6-H-4 Formulas of the MUTCD for Determining Taper Length for the distance L. Speeds shall be posted speeds.

3. See Table 11 – 4 for the required spacing of channelizing devices.

## **EF TRANSPORTATION OPERATIONS PLAN ~~WORK ZONE~~ MANAGEMENT**

The Transportation Operations Plan (TOP) addresses operations and management of the transportation system in the work zone impact area. ~~Roadwork~~ Management of construction, maintenance, and emergency response –operations shall support follow ~~the~~ an appropriate TTCP temporary traffic control plan.

### **F.1 Public Information**

~~All reasonable effort should be made to inform the public of the location, duration, and nature of impending roadwork operations. Transit agencies should be given advanced notice of planned operations so they can be responsible for notifying their passengers.~~

### **EF.12 Contracts and Permits**

~~For construction and reconstruction projects, t~~The general work zone layout; planned detours, traffic control and protection procedures; occupational safety and health requirements; and specific traffic control devices required should be incorporated in the contract plans and specifications.

#### **E.1.a Utilities**

New utility installations in public rights of way are prohibited unless a permit by the appropriate highway agency with jurisdiction over the facility is issued. Permits for routine maintenance (e.g., deteriorated pole/equipment replacement), minor alterations (e.g., changes in cable, wire, or transformer size), service drops, or emergency work will be determined by the agency with jurisdiction over the facility ~~should generally not be required.~~ Occupational Safety and Health Administration (OSHA) regulations for work zone safety should be reviewed prior to any construction by utility companies involving encroachment into of the transportation facility highway right of way by workers, equipment ~~equipment~~, or material.

#### **E.1.b Wildlife Sensitive Lighting**

If lighting is provided in a work zone along coastal roadways where sea turtles may be affected, see **Section J of Chapter 6 – Lighting for**

requirements and further information. In addition to the resources in Chapter 6, coordinate with the local agencies for additional guidance with providing lighting in work zones.

### **EF.23**      **Inspection and Supervision**

A regular program of inspection and supervision of all construction and maintenance projects shall be established and executed.

## **F**      **PUBLIC INFORMATION PLAN**

During construction, the Public Involvement Plan (PIP) serves a public information role, informing people about work zone limits, sidewalk, shared use path or travel lane closures, median changes, detours, business access impacts, work hours, and grand openings. A major function is to provide up-to-date information and solicit concerns to minimize the disruption to residents, businesses, and the traveling public during the construction phase.

Some agencies may hold pre-construction open houses, which can either be formal meetings held in enclosed spaces or informal activities conducted within the project corridor.

Below is a summary of activities which could be included in a PIP:

- Determine need for a project specific public information officer (prior to scope for construction engineering and inspection)
- Handoff meeting from design to construction (after letting)
- Mass mailing of project information flyer/brochure (two to four weeks prior to construction)
- Project information meeting/open house (two to four weeks prior to construction)
- Presentations to other local governments, community groups, or general public as needed
- Construction notices included in weekly traffic report (one week prior and throughout construction)

In addition to traditional public information meetings, some projects may benefit

from other methods such as one-on-one meetings, an up-to-date project website, and social media. Variable message signs (VMS) are routinely used to communicate lane closures and changes in access.

All reasonable effort should be made to inform the public of the location, duration, and nature of impending work. Transit agencies should be given advance notice of planned operations so they can make adjustments in service or routes if needed, and coordinate with passengers.

## **G EVALUATION OF PROGRAM**

The entire program for work zone safety should be periodically evaluated and revised to provide the safest practicable environment for workers, pedestrians, bicyclists, and motorists during roadwork operations.

## CHAPTER 12

### CONSTRUCTION

A	INTRODUCTION .....	12-1
B	OBJECTIVES .....	12-1
C	CONTROL OF THE WORK.....	12-2
C.1	Plans and Contract Documents .....	12-2
C.1.a	Plans .....	12-2
C.1.b	Alterations in Plans .....	12-2
C.1.c	Working Drawings (for Structures).....	12-3
C.1.c.1	General .....	12-3
C.1.c.2	Submission of Working, Shop, and Erection Drawings .....	12-3
C.1.c.3	Responsibility for Accuracy of Working Drawings .....	12-3
C.2	Coordination of Plans, Specifications, and Special Provisions.....	12-4
C.3	Conformity of Work with Plans .....	12-4
C.4	Conformity of Work Shown in Regulatory Permits .....	12-5
C.5	Authority of the Construction Engineer.....	12-5
C.6	Engineering and Layout .....	12-5
C.6.a	Control Points Furnished.....	12-5
C.6.b	Layout of Work.....	12-5
C.6.c	Personnel, Equipment, and Record Requirements .....	12-5
C.7	Contractor's Supervision .....	12-6
C.7.a	Prosecution of Work.....	12-6
C.7.b	Contractor's Superintendent .....	12-6
C.7.c	Supervision for Emergencies .....	12-6
C.8	General Inspection Requirements.....	12-6
C.8.a	Cooperation by Contractor .....	12-6
C.8.b	Failure of Construction Engineer to Reject Work During Construction.....	12-7
C.8.c	Qualifications for Services for FDOT Administered Projects.....	12-7

C.9	Final Construction Inspection Maintenance until Final Acceptance ...	12-7
D	CONTROL OF MATERIALS.....	12-7
D.1	Source of Supply and Quality Requirements .....	12-7
D.1.a	Only Approved Materials to be Used .....	12-7
D.2	Inspection and Tests at Source of Supply.....	12-8
D.2.a	General .....	12-8
D.2.b	Cooperation by Contractor.....	12-8
D.3	Control by Samples and Tests .....	12-8
D.3.a	Materials to be Tested, Samples.....	12-8
D.3.b	Applicable Standards .....	12-8
D.4	Quality Control System .....	12-9
D.4.a	General Requirements.....	12-9
D.4.b	Documentation.....	12-9
D.4.c	Corrective Actions.....	12-9

## CHAPTER 12

### CONSTRUCTION

#### A INTRODUCTION

The purpose of this chapter is to establish guidelines for field procedures, as they pertain to control of construction projects, supervision, and contract administration. All construction projects require an inspection process to administer the contract, to certify the project has been constructed within reasonable conformance with the plans/specifications, and the materials which were incorporated into the project were properly tested/certified.

All construction projects require:

- An inspection procedure to administer the contract
- Certification

The Engineer of Record (EOR) is a Professional Engineer registered in the State of Florida that develops the criteria and concept for the project, performs the analysis, and is responsible for the preparation of the Plans and Specifications. The Maintaining Authority's Engineer of Record may be in-house staff or a consultant.

The Construction Engineer (CE) is a Professional Engineer registered in the State of Florida that supervises the construction of the project. The Maintaining Authority's Construction Engineer or Designee may assign in-house staff or a consultant to act on their behalf.

#### B OBJECTIVES

Construction of street and highway facilities is the result of the effort, of the engineer, the contractor, and the owner. Minimum construction standards shall be followed to provide for proper implementation of the design. The following general objectives for roadway construction should be followed to ensure proper construction:

- All construction performed and all materials utilized shall be in reasonably close conformity with the construction plans and contract documents.



- The responsibilities and obligations of the owner, engineer, and contractor should be clearly defined.
- A safe working environment shall be provided in accordance with **Chapter 11 – Work Zone Safety and Mobility**.
- Adequate procedures through established methods of sampling and testing shall be implemented to provide for the control and placement of materials.

## C CONTROL OF THE WORK

### C.1 Plans and Contract Documents

The Contractor will be furnished an appropriate number of copies of the plans and special provisions as required for the particular project. The Contractor shall have available at the work site, at all times, one copy each of the plans (including relevant Design Standards), Specifications, and Special Provisions.

#### C.1.a Plans

The plans furnished consist of general drawings showing such details which are necessary to give a comprehensive idea of the construction contemplated. Roadway plans will show, in general, alignment, profile grades, typical cross sections, and general cross sections as necessary. Structure plans, in general, will show in detail all dimensions of the work contemplated.

#### C.1.b Alterations in Plans

No changes shall be made on any plan or drawing after it is approved by the EOR Engineer, except as authorized in writing by the EOR Engineer. Minor changes may be approved by the Construction Engineer in consultation with the EOR.

All authorized alterations affecting the requirements and information given on the approved plans shall be in writing.

## **C.1.c Working Drawings (for Structures)**

### **C.1.c.1 General**

The Contractor shall furnish such working, shop, and erection drawings, as may be required, to complete the structure in compliance with the design shown on the plans.

### **C.1.c.2 Submission of Working, Shop, and Erection Drawings**

All working, shop, and erection drawings prepared by the Contractor or his agents (subcontractor, fabricator, supplier, etc.) shall be reviewed, dated, stamped, approved, and signed by the Contractor prior to submission to the ~~EOR~~ **Engineer of Record** for review. The Contractor's signed approval of drawings submitted shall confirm he/she has verified the work requirements, field measurements, construction criteria, sequence of assembly and erection, access and clearances, catalog numbers, and other similar data. Each series of drawings shall indicate the specification section and page or drawing number of the contract plans to which the submission applies. The Contractor shall indicate on the working, shop, and erections drawings all deviations from the contract drawings and shall itemize all deviations in his letter of transmittal.

### **C.1.c.3 Responsibility for Accuracy of Working Drawings**

It is understood that approval by the ~~EOR~~ **Engineer** of the Contractor's working drawings does not relieve the Contractor of any responsibility for accuracy of dimensions and details, or for conformity of dimensions and details. The Contractor shall be responsible for agreement and conformity of his working drawings with the approved plans and specifications.

## C.2 Coordination of Plans, Specifications, and Special Provisions

The specifications, plans, special provisions, and all supplemental documents are integral parts of the contract, and a requirement occurring in one is as binding as though occurring in all. They are to be complementary and to describe and provide for a complete work.

In cases of discrepancy, the governing order of the documents shall be as follows:

- Special Provisions
- Plans
- Standard Drawings
- Specifications

## C.3 Conformity of Work with Plans

All work performed and all materials furnished shall be in reasonably close conformity with the lines, grades, cross sections, dimensions, and material requirements, including tolerances, shown on the plans or indicated in the specifications.

In the event the ~~CE Construction Engineer~~ finds the materials or the finished product in which the materials are used not within reasonably close conformity with the plans and specifications, but reasonably acceptable work has been produced, he/she shall then make a determination if the work shall be accepted and remain in place. In this event, the ~~CE Engineer~~ will document the basis of acceptance by contract modification which will provide for an appropriate adjustment in the contract price for such work or materials as he deems necessary to conform to his determination based on engineering judgment.

In the event the ~~CE Engineer~~ finds the materials, or the finished product in which the materials are used, or the work performed, are not in reasonably close conformity with the plans and specifications and have resulted in an inferior or unsatisfactory product, the work or materials shall be removed and replaced or otherwise corrected by and at the expense of the Contractor.

## **C.4 Conformity of Work Shown in Regulatory Permits**

All work shall be accomplished in accordance with special conditions of the regulatory permits.

## **C.5 Authority of the Construction Engineer**

All work shall be performed to the satisfaction of the CEEngineer.

## **C.6 Engineering and Layout**

### **C.6.a Control Points Furnished**

Horizontal and vertical control points are required at appropriate intervals along the line of the project to facilitate the proper layout of the work. The Contractor shall preserve all control points furnished.

### **C.6.b Layout of Work**

Utilizing the control points furnished, all horizontal and vertical controls shall be established as necessary to construct the work in conformance with the plans and specifications. The work shall include performing all calculations required and setting all stakes needed, such as grade stakes, offset stakes, reference point stakes, slope stakes, and other reference marks or points necessary to provide lines and grades for construction of all roadway, bridge, and miscellaneous items.

### **C.6.c Personnel, Equipment, and Record Requirements**

The Contractor shall employ only competent personnel and utilize only suitable equipment in performing layout work.

Adequate field notes and records shall be kept as layout work is accomplished. These field notes and records shall be available for review by the CEEngineer as the work progresses and copies shall be furnished to the CEEngineer at the time of completion of the project. Any inspection or checking of the Contractor's field notes or layout work by the CEEngineer, and the acceptance of all or any part thereof, shall not relieve the Contractor of his responsibility to achieve the lines, grades, and dimensions shown in the plans and specifications.

## C.7 Contractor's Supervision

### C.7.a Prosecution of Work

The Contractor shall give the work the constant attention necessary to assure the scheduled progress and shall cooperate fully with the CEEngineer and with other contractors at work in the vicinity.

### C.7.b Contractor's Superintendent

The Contractor shall at all times have on the work site, as his/her agent, a competent superintendent capable of thoroughly interpreting the plans and specifications and thoroughly experienced in the type of work being performed, and who shall receive the instructions from the CEEngineer or his/her authorized representatives. The superintendent shall have full authority to execute the orders or directions of the CEEngineer and to supply promptly any materials, tools, equipment, labor, and incidentals which may be required. Such superintendence shall be furnished regardless of the amount of work sublet.

### C.7.c Supervision for Emergencies

The Contractor shall have a responsible person available at or reasonably near the work site on a twenty-four hour basis, seven days a week, in order that he/she may be contacted in emergencies and in cases where immediate action must be taken to maintain traffic or to handle any other problems that might arise. The Contractor shall be responsible for initiating, installing, and maintaining all traffic control devices as described in **Chapter 11 – Work Zone Safety and Mobility** and in the plans.

## C.8 General Inspection Requirements

### C.8.a Cooperation by Contractor

No work shall be done nor materials used without suitable supervision or inspection by the CEEngineer. The Contractor shall furnish the CEEngineer with every reasonable facility for ascertaining whether the work performed and materials used are in accordance with the requirements and intent of the plans and specifications.

### **C.8.b Failure of Construction Engineer to Reject Work During Construction**

If, during or prior to construction operations, the CEEngineer should fail to reject defective work or materials, whether from lack of discovery of such defect or for any reason, such initial failure to reject shall in no way prevent his/her later rejection when such defect is discovered.

### **C.8.c Qualifications for Services for FDOT Administered Projects**

For projects administered by a local government that are wholly or partially funded by the FDOT, there are limitations on who may perform design, and Construction Engineering and Inspection services (CEI). See [F.S. 337.14 \(7\) Application for qualification; certificate of qualification; restrictions, request for hearing](#) for more information.

## **C.9 Final Construction Inspection Maintenance until Final Acceptance**

The Contractor shall maintain all work in first-class condition until it has been completed as a whole and has been accepted by the CEEngineer. When all materials have been furnished, all work has been performed, and the construction contemplated by the contract has been satisfactorily completed, the CEEngineer will make the final inspection.

## **D CONTROL OF MATERIALS**

### **D.1 Source of Supply and Quality Requirements**

#### **D.1.a Only Approved Materials to be Used**

Only materials conforming to the requirements of the specifications and approved by the Engineer shall be used in the work. Any materials proposed for use may be inspected or tested at any time during their preparation and use. No material which, after approval, has in any way become unfit for use, shall be used in the work.

## D.2 Inspection and Tests at Source of Supply

### D.2.a General

The CEEngineer may undertake the inspection of materials at the source of supply.

### D.2.b Cooperation by Contractor

The Contractor shall assure the CEEngineer has free entry at all times to such parts of the plant as concern the manufacture or production of the materials ordered, and shall bear all costs incurred in providing all reasonable facilities to assist in determining whether the material furnished complies with the requirements of the specifications.

## D.3 Control by Samples and Tests

### D.3.a Materials to be Tested, Samples

The CEEngineer may require any or all materials to be subjected to tests by means of samples or otherwise, at production points, after delivery, or both, as he/she may determine.

### D.3.b Applicable Standards

Methods of sampling and testing materials shall conform to the CEEngineer's requirements and should be in accordance with **Florida Sampling and Testing Methods (FSTM)** so far as covered therein. Otherwise, they should be in accordance with Standards of AASHTO, ASTM, or other criteria as specifically designated by the CEEngineer. Where an AASHTO, ASTM, or other non-Florida Method is designated, but a Florida Method which is similar exists, sampling and testing should be in accordance with the Florida Method.

Whenever in these Specifications, FSTM, AASHTO, ASTM, or other standards are referenced without identification of the specific time of issuance, the reference should be construed to mean the most current issuance, including interims or addendums thereto, at the time of advertisement for bids for a project.

## **D.4 Quality Control System**

### **D.4.a General Requirements**

The Contractor shall furnish and maintain a quality control system that will provide reasonable assurance that all materials and products submitted for acceptance conform to the contract requirements, whether manufactured or processed by the Contractor or procured from suppliers or subcontractors. The Contractor shall perform or have performed the inspection and tests required to substantiate product conformance to contract requirements and shall also perform or have performed all inspections and tests otherwise required by the contract.

### **D.4.b Documentation**

The Contractor shall maintain adequate records of all inspections and tests. The records shall indicate the nature and number of tests made, the number and type of deficiencies found, the quantities approved and rejected, and the nature of corrective action taken, as appropriate.

### **D.4.c Corrective Actions**

The Contractor shall take prompt action to correct any errors, equipment malfunctions, process changes, or other assignable causes which have resulted or could result in the submission of materials, products, and completed construction which do not conform to the requirements of the specifications.



**THIS PAGE INTENTIONALLY LEFT BLANK**

## CHAPTER 13

### PUBLIC TRANSIT

A	INTRODUCTION .....	13-1
B	OBJECTIVE .....	13-2
C	TRANSIT COMPONENTS .....	13-3
C.1	Boarding and Alighting (B&A) Areas .....	13-3
	Figure 13 – 1 Boarding and Alighting Area for Flush Shoulder Roadways with Connection to the Roadway .....	13-4
	Figure 13 – 2 Boarding and Alighting Area for Flush Shoulder Roadways with Connection to the Sidewalk .....	13-5
C.2	Shelters .....	13-6
	Figure 13 – 3 Bus Shelter Location .....	13-6
C.3	Benches .....	13-7
C.4	Stops and Station Areas .....	13-7
C.5	Bus Bays (Pullout or Turnout Bays) .....	13-7
D	PUBLIC TRANSIT FACILITIES .....	13-7
D.1	Curb-Side Facilities .....	13-8
D.2	Street-Side Facilities .....	13-8
D.3	Bus Stop Lighting .....	13-8
	Figure 13 – 4 Bus Stop Locations .....	13-9
E	REFERENCES FOR INFORMATIONAL PURPOSES .....	13-10

## FIGURES

Figure 13 – 1	Boarding and Alighting Area for Flush Shoulder Roadways with Connection to the Roadway .....	13-4
Figure 13 – 2	Boarding and Alighting Area for Flush Shoulder Roadways with Connection to the Sidewalk.....	13-5
Figure 13 – 3	Bus Shelter Location .....	13-6
Figure 13 – 4	Bus Stop Locations.....	13-9

## CHAPTER 13

### PUBLIC TRANSIT

#### A INTRODUCTION

All modes of transportation (autos, trucks, transit vehicles, rails, aircraft, water craft, bicyclists, and pedestrians) ~~shall~~<sup>should</sup> be considered when planning, designing, and constructing the surface transportation system. Where there is a demand for highways to serve vehicles, there could also be a demand for public transit or public transportation. Public transit should be considered in all phases of a project, including planning, preliminary design and engineering, design, construction, and maintenance. Coordination with the appropriate public transit provider(s) will help determine the need for transit related infrastructure on a project-by-project basis. The integration of public transit street side facilities along with pedestrian and bicycle facilities furthers the implementation of this goal.

Planning and designing for public transit is important because it is an integral part of the overall surface transportation system. Public transit is defined as passenger transportation service, local or regional in nature, which is available to any person. It operates on established schedules along designated routes or lines with specific stops and is designed to move relatively large numbers of people at one time. Public transit includes bus, light rail, street cars, bus rapid transit and paratransit.

With rising levels of congestion resulting in the use of new strategies to effectively and efficiently manage mobility, there is an increased demand for accessible and user friendly public transit. New strategies include increased emphasis on public transit and new emphasis on Transportation System Management (TSM), as well as Transportation Demand Management (TDM). TSM is the use of low cost capital improvements to increase the efficiency of roadways and transit services such as; retiming traffic signals or predestinating traffic flow. TDM focuses on people reducing the number of personal vehicle trips, especially during peak periods. TDM includes the promotion of alternatives to the single occupant vehicle, including public transportation, carpooling, vanpooling, bicycling, walking, and telecommuting, as well as other methods for reducing peak hour travel.

Federal and State legislation provide the stimulus for planning, designing, and constructing a fully integrated transportation system benefiting the traveling public and

the environment. Examples of legislation include [\*Fixing America's Surface Transportation Act \(FAST Act\)\*](#), [\*Americans with Disabilities Act of 1990 \(ADA\)\*](#), and [\*Clean Air Act Amendment of 1990 \(CAAA\)\*](#). In response to this legislation, the surface transportation system should provide for concurrent use by automobiles, public transit and rail, bicycles, and pedestrians.

## **B OBJECTIVE**

There are ~~a number of~~[several](#) methods to efficiently develop a coordinated surface transportation system. Coordination among agencies is necessary during the planning and design stages to:

- incorporate transit needs and during the construction phase for re-routing bus (and complementary pedestrian) movements, and
- for actual transit agency specific requirements (e.g., bus stop sign replacement, shelter installations, etc.).

For planning purposes, the state and local Transportation Improvement Program (TIP) should be referenced. Additionally, individual transit authorities have ten-year Transit Development Plans (TDPs) that are updated annually. The TDP can be used as a guide for planned transit needs along existing and new transportation corridors so transit consideration and transit enhancements can be incorporated where appropriate.

## C TRANSIT COMPONENTS

### C.1 Boarding and Alighting (B&A) Areas

Boarding and Alighting (B&A) areas help to create an accessible bus stop by providing a raised platform that is compatible with a bus that kneels or extends a ramp. A B&A area has a firm, stable and slip-resistant surface with a minimum clear length of 8.0 feet (measured perpendicular to the curb or roadway edge), and a minimum clear width of 5.0 feet (measured parallel to the roadway). Firm, stable, and slip resistant B&A areas are required if amenities such as benches or shelters are added to a bus stop. B&A areas are not required at bus stops on flush shoulder roadways where only a bus stop sign is provided. Coordinate with the appropriate public transit provider(s) to determine compatibility with equipment and transit vehicles.

The slope of the B&A area parallel to the roadway shall to the extent practicable, be the same as the roadway. For water drainage, a maximum slope of ~~1:50 (2%)~~ perpendicular to the roadway is allowed. Benches and other site amenities shall not be placed on the B&A area. The B&A area can be located either within or outside the shelter, and shall be connected to streets, sidewalks, or pedestrian circulation paths by an accessible route.

On flush shoulder roadways, a B&A area may be constructed at the shoulder point (or edge of shoulder pavement on roadways with a design speed of 45 mph or less) as shown in Figures 13 – 1 and 13 – 2 Boarding and Alighting Area for Flush Shoulder Roadways. A Type “E” curb (5” curb height) should be used.

A sidewalk and/or ramp provided with the B&A area shall be a minimum of 5 feet in width, and the ramp shall not exceed a slope of 1:12. A detectable warning is required where a sidewalk associated with a B&A area connects to the roadway at grade. Except for the area adjacent to the 5” curb, the areas surrounding the B&A area shall be flush with the adjacent shoulder and side slopes and designed to be traversable by errant vehicles. On the upstream side of the platform, a maximum slope of 1:12 should be provided, and may be grass or a hardened surface. The B&A area (and ramp and level landing if needed) should be constructed with 6” thick concrete.

**Figure 13 – 1 Boarding and Alighting Area for Flush Shoulder Roadways with Connection to the Roadway**

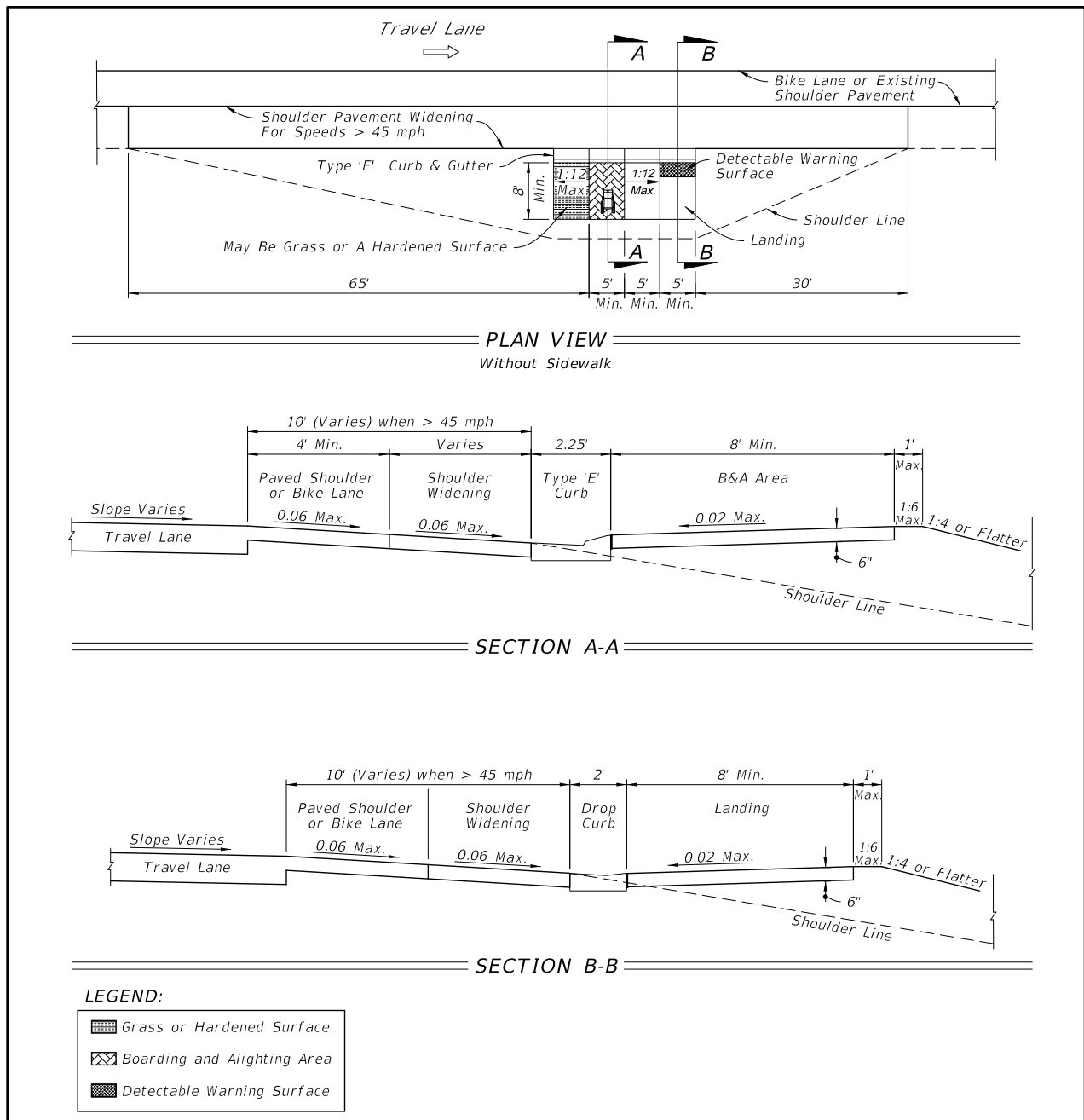

**Figure 13 – 2 Boarding and Alighting Area for Flush Shoulder Roadways with Connection to the Sidewalk**

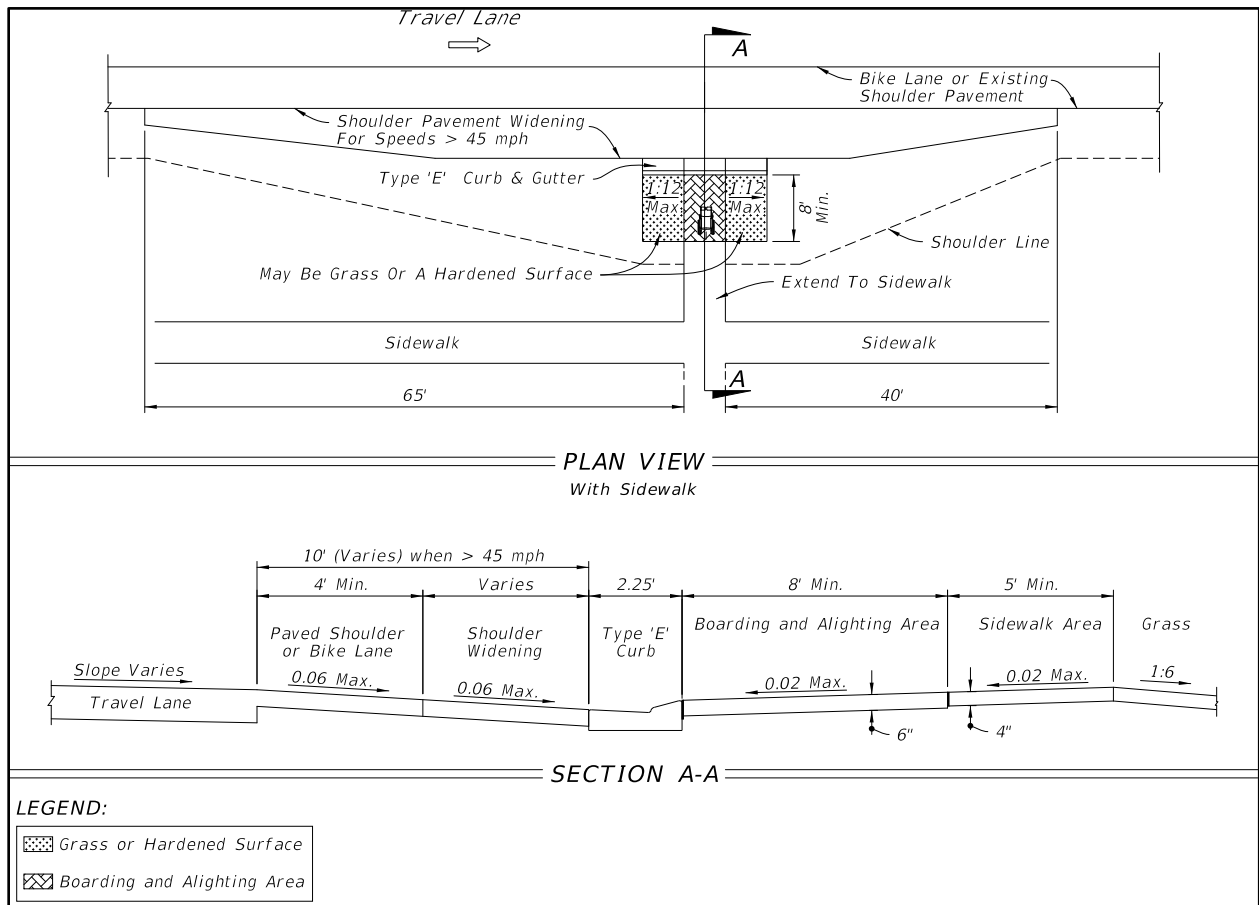



## C.2 Shelters

Every public transit system has different needs with regards to shelters and corresponding amenities (e.g., benches, information kiosks, leaning posts, trash receptacles, etc.). Shelter foundation and associated pad size vary from stop to stop based on right of way availability, line of sight, and facility usage. New or replaced bus shelters shall be installed or positioned to provide an accessible route from the public way (sidewalk or roadway) to reach a location that has a minimum clear floor area of 30 inches by 48 inches, entirely within the perimeter of the shelter.

Shelters shall be connected by an accessible route to a B&A area. Coordinate with the appropriate public transit provider(s). Where feasible, shelters should provide a location for a bicycle rack. Shelters should be installed at locations where demand warrants installation and in accordance with clear zone criteria in **Chapter 3 – Geometric Design, Section C.10.e** Bus Benches and Transit Shelters and **Chapter 4 – Roadside Design**, Table 4 – ~~24~~ **Lateral Offset** **Minimum Width of Clear Zone** of this Manual.

**Figure 13 – 3 Bus Shelter Location**

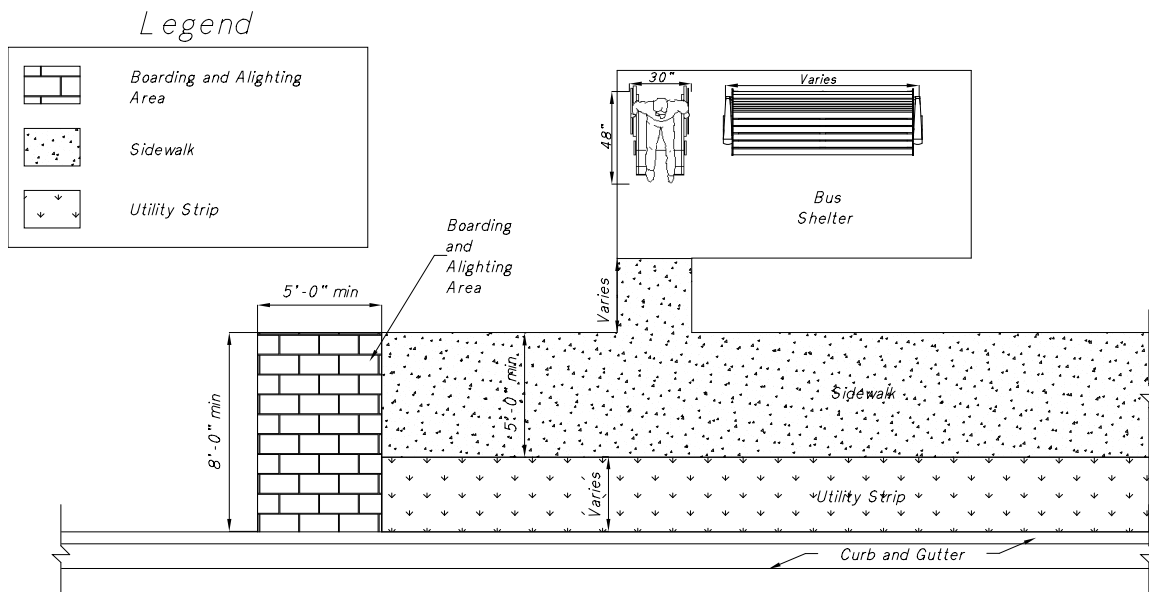

### **C.3 Benches**

If a bench is provided, it should be on an accessible route, out of the path of travel on a sidewalk. Benches shall have an adjacent firm, stable and slip-resistant surface at least 30 inches wide and 48 inches deep to allow a user of a wheelchair to sit next to the bench, permitting the user shoulder-to-shoulder seating with a companion. Connection between the bench, sidewalk and/or bus B&A area shall be provided. Coordinate with the local public transit provider(s).

### **C.4 Stops and Station Areas**

Transit stops should be located so that there is a level and stable surface for boarding vehicles. Locating transit stops at signalized intersections increases the usability for pedestrians with disabilities.

### **C.5 Bus Bays (Pullout or Turnout Bays)**

Bus bays for transit vehicles may be necessary (e.g., extended dwell time, layover needs, safety reasons, high volumes or speed of traffic.). Bus bays can be designed for one or more buses. Coordinate with the local public transit provider(s) to determine the need for bus bays. When possible, bus bays should be located on the far side of a signalized intersection. The traffic signal will create the critical gap needed for bus re-entry into traffic. There are several publications available which provide additional design information for transit system applications. The ~~FDOT Department~~ District Public Transportation Office(s) maintains a library of these publications.

## **D PUBLIC TRANSIT FACILITIES**

When a project includes a public transit route, curb-side and street-side transit facilities for bus stops should be considered in the roadway design process. Transit facilities shall comply with [Chapter 14-20, Florida Administrative Code](#).

The “Accessing Transit: Design Handbook for Florida Bus Passenger Facilities” provides guidance relating to provisions for curb-side and street-side facilities.