

# PART 3

## MARKINGS

### CHAPTER 3A. GENERAL

#### Section 3A.01 Standardization of Application

Support:

- 01 Markings are used to supplement other traffic control devices such as signs, signals, and other markings. In other instances, markings are used alone to effectively convey regulations, warnings, or guidance in ways not obtainable by the use of other devices.
- 02 Markings can take many forms including road surface markings, curb markings, delineators, colored pavements, and channelizing devices.

**Standard:**

- 03 **Each standard marking shall be used only to convey the meaning prescribed for that marking in this Manual, including when used for applications not described in this Manual.**
- 04 **Except as provided in Chapter 3H, markings that must be visible at night shall be retroreflective unless the markings are adequately visible under street or highway lighting. All markings on Interstate highways shall be retroreflective.**
- 05 **Markings that are no longer applicable for roadway conditions or restrictions and that might cause confusion for the road user shall be removed or obliterated to be unidentifiable as a marking as soon as practicable.**

Option:

- 06 Until they can be removed or obliterated, markings that are no longer applicable for roadway conditions or restrictions may be temporarily masked with non-reflective, preformed tape that is approximately the same color as the pavement surface.

#### Section 3A.02 Materials

*Guidance:*

- 01 *The materials used for markings should provide the specified color throughout their useful life.*
- 02 *Consideration should be given to selecting pavement marking materials that will minimize tripping or loss of traction for road users, including pedestrians, bicyclists, and motorcyclists.*

Option:

- 03 Marking systems that consist of clumps or droplets of material with visible open spaces of bare pavement between the material droplets, which can function in a manner that is similar to the marking systems that completely cover the pavement surface, may be used as pavement markings if they meet the other pavement marking requirements of the highway agency.

#### Section 3A.03 Colors

**Standard:**

- 01 **Markings shall be yellow, white, red, blue, or purple. The colors for markings shall conform to the standard highway colors.**

Option:

- 02 Black markings may be used in combination with the colors mentioned in Paragraph 1 of this Section to enhance the contrast with a light-colored pavement.

**Standard:**

- 03 **When used, yellow markings for longitudinal lines shall delineate:**
- A. The separation of traffic traveling in opposite directions,
  - B. The left-hand edge of the roadways of divided highways and one-way streets or ramps, or
  - C. The separation of two-way left-turn lanes and reversible lanes from other lanes.
- 04 **When used, white markings for longitudinal lines shall delineate:**
- A. The separation of traffic flows in the same direction,
  - B. The right-hand edge of the roadway, or
  - C. Both the right-hand edge and left-hand edge of a reversible roadway.

- 05 **When used, red raised pavement markers or delineators shall delineate:**
- A. Truck escape ramps, or
  - B. One-way roadways, ramps, or travel lanes that shall not be entered or used in the direction from which the markers are visible.
- 06 **When used, blue markings shall supplement white markings for parking spaces for persons with disabilities.**
- 07 **When used, purple markings shall be in accordance with the provisions of Chapter 3F to identify toll plaza approach lanes restricted to use only by vehicles with registered electronic toll collection accounts.**
- 08 **When pavement markings that simulate route signs are used (see Section 3B.22), the colors shall be the same as those that are used for the route signs (see Section 2D.11).**
- Support:
- 09 Provisions regarding colored pavements are contained in Chapter 3H.

### **Section 3A.04 Functions, Widths, and Patterns of Longitudinal Pavement Markings**

#### **Standard:**

- 01 **The general functions of longitudinal lines shall be as follows:**
- A. A double line indicates maximum or special restrictions.
  - B. A solid line discourages or prohibits crossing (depending on the specific application).
  - C. A broken line indicates a permissive condition.
  - D. A dotted lane line provides warning of a downstream change in lane function.
  - E. A dotted line used as a lane line or edge line extension guides vehicles through an intersection, a taper area, or an interchange ramp area.
- 02 **The widths and patterns of longitudinal lines shall be as follows:**
- A. Normal line—4 to 6 inches wide.
  - B. Wide line—at least twice the width of a normal line.
  - C. Double line—two parallel lines separated by a discernible space. The pavement surface shall be visible between the lines in the same way that it is visible outside the lines, except where contrast markings are used in combination with the double line (see Section 3A.03).
  - D. Broken line—normal width line segments separated by gaps.
  - E. Dotted line—noticeably shorter line segments separated by shorter gaps than used for a broken line. The width of a dotted line extension shall be at least the same as the width of the line it extends.

#### *Guidance:*

- 03 *To be recognized as a double line rather than two separate, disassociated single lines, the discernible space separating the parallel lines of a double line should not exceed two times the line width of a single line.*

#### Support:

- 04 The width of the line indicates the degree of emphasis.
- 05 Increasing edge line width from 4 inches to 6 inches has been shown to be a beneficial countermeasure to enhance safety at locations with a history of run-off-the-road crashes (see Section 3B.09). Wider normal lines with a 6-inch width instead of the minimum 4-inch width can be beneficial to both human drivers and driving automation systems (see Section 5B.02).

#### *Guidance:*

- 06 *Broken lines should consist of 10-foot line segments and 30-foot gaps, or dimensions in a similar ratio of line segments to gaps as appropriate for traffic speeds and the need for delineation.*
- 07 *A dotted line used as a lane line (see Section 3B.07) should consist of 3-foot line segments and 9-foot gaps. A dotted line for line extensions within an intersection, taper area, or interchange ramp area (see Section 3B.11) should consist of 2-foot line segments and 2-foot to 6-foot gaps.*

#### Support:

- 08 Section 5B.02 contains information on pavement marking considerations for driving automation systems.

### **Section 3A.05 Maintaining Minimum Pavement Marking Retroreflectivity**

#### **Standard:**

- 01 **Except as provided in Paragraph 5 of this Section, a method designed to maintain retroreflectivity at or above 50 mcd/m<sup>2</sup>/lx under dry conditions shall be used for longitudinal markings on roadways with speed limits of 35 mph or greater.**

*Guidance:*

- 02 *Except as provided in Paragraph 5 of this Section, a method designed to maintain retroreflectivity at or above 100 mcd/m<sup>2</sup>/lx under dry conditions should be used for longitudinal markings on roadways with speed limits of 70 mph or greater.*
- 03 *The method used to maintain retroreflectivity should be one or more of those described in “Methods for Maintaining Pavement Marking Retroreflectivity” (FHWA-SA-22-028), 2022 Edition, FHWA or developed from an engineering study based on the values in Paragraphs 1 and 2 of this Section.*

## Support:

- 04 Retroreflectivity levels for pavement markings are measured with an entrance angle of 88.76 degrees and an observation angle of 1.05 degrees. This geometry is also referred to as 30-meter geometry. The units of pavement marking retroreflectivity are reported in mcd/m<sup>2</sup>/lx, which means millicandelas per square meter per lux.

## Option:

- 05 The following markings may be excluded from the provisions established in Paragraphs 1 and 2 of this Section:
- A. Markings where ambient illumination assures that the markings are adequately visible;
  - B. Markings on streets or highways that have an ADT of less than 6,000 vehicles per day;
  - C. Dotted extension lines that extend a longitudinal line through an intersection, major driveway, or interchange area (see Section 3B.11);
  - D. Curb markings;
  - E. Parking space markings; and
  - F. Shared-use path markings.

## Support:

- 06 The provisions of this Section do not apply to non-longitudinal pavement markings including, but not limited to, the following:
- A. Transverse markings;
  - B. Word, symbol, and arrow markings;
  - C. Crosswalk markings; and
  - D. Chevron, diagonal, and crosshatch markings.
- 07 Special circumstances will periodically cause pavement marking retroreflectivity to be below the minimum levels. These circumstances include, but are not limited to, the following:
- A. Isolated locations of abnormal degradation;
  - B. Periods preceding imminent resurfacing or reconstruction;
  - C. Unanticipated events such as equipment breakdowns, material shortages, and contracting problems; and
  - D. Loss of retroreflectivity resulting from snow maintenance operations.
- 08 When such circumstances occur, compliance with Paragraphs 1 and 2 of this Section is still considered to be achieved if a reasonable course of action is taken to resume maintenance of minimum retroreflectivity in a timely manner according to the maintaining agency’s method(s), policies, and procedures.

## CHAPTER 3B. PAVEMENT AND CURB MARKINGS

### Section 3B.01 Yellow Center Line Pavement Markings

**Standard:**

01 Center line pavement markings, when used, shall be the pavement markings used to delineate the separation of traffic lanes that have opposite directions of travel on a roadway and shall be yellow.

**Option:**

02 Center line pavement markings may be placed at a location that is not the geometric center of the roadway.

03 On roadways without continuous center line pavement markings, short sections may be marked with center line pavement markings to control the position of traffic at specific locations, such as around curves, over hills, on approaches to grade crossings, at grade crossings, and at bridges.

**Standard:**

04 The center line markings on two-lane, two-way roadways shall be one of the following as shown in Figure 3B-1:

- A. Two-direction passing zone markings consisting of a normal width broken yellow line where crossing the center line markings for passing with care is permitted for traffic traveling in either direction;
- B. One-direction no-passing zone markings consisting of a double yellow line, one of which is a normal width broken yellow line and the other is a normal width solid yellow line, where crossing the center line markings for passing with care is permitted for the traffic traveling adjacent to the broken line, but is prohibited for traffic traveling adjacent to the solid line; or
- C. Two-direction no-passing zone markings consisting of two normal width solid yellow lines where crossing the center line markings for passing is prohibited for traffic traveling in either direction.

05 A single solid yellow line shall not be used as a center line marking on a two-way roadway.

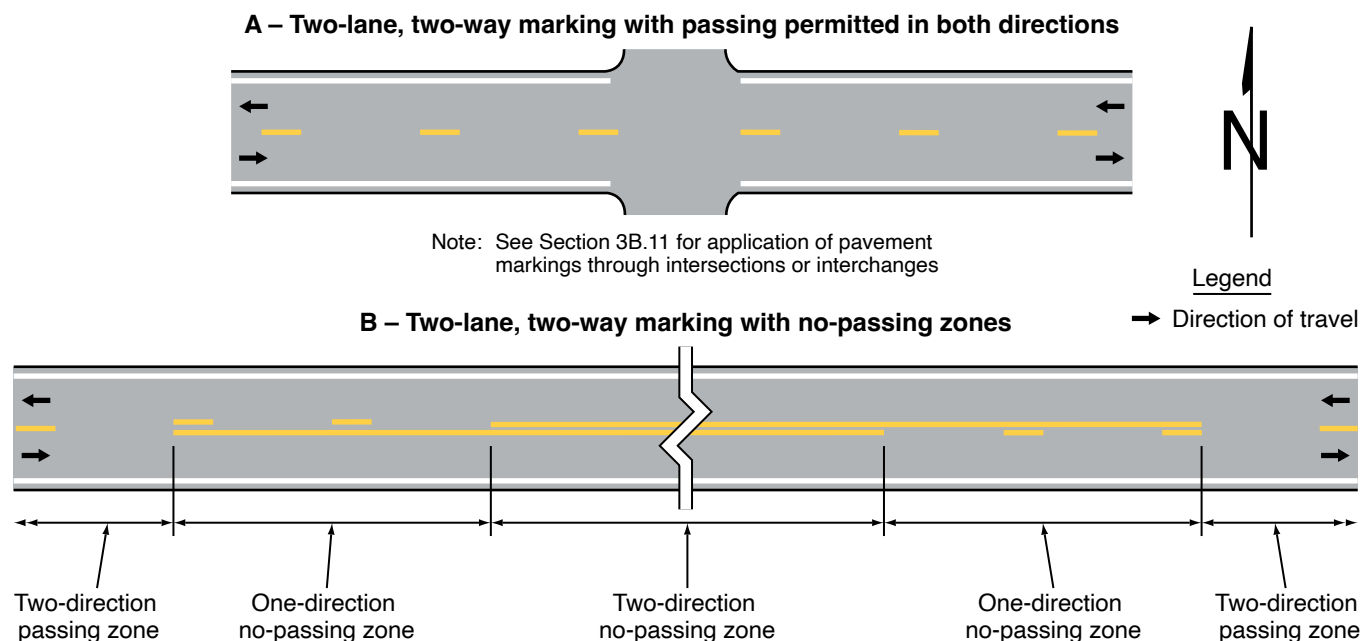
06 Except where a reversible lane (see Section 3B.04) or a two-way left-turn lane (see Section 3B.05) is present, the center line markings on undivided two-way roadways with four or more lanes for moving motor vehicle traffic always available shall be the two-direction no-passing zone markings consisting of normal width double solid yellow lines as shown in Figure 3B-2.

**Guidance:**

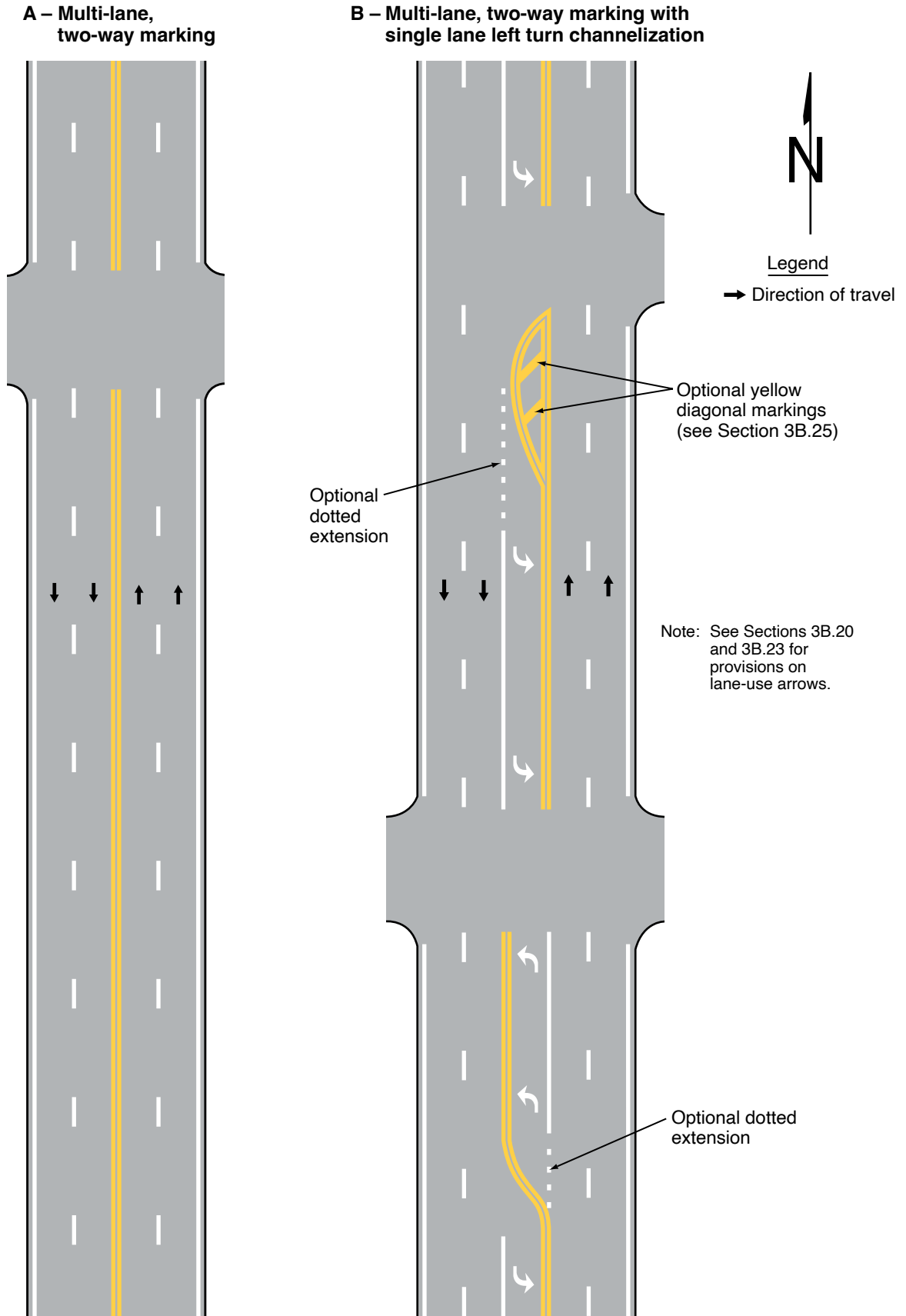
07 Section 3B.11 contains information for application of pavement markings through intersections or interchanges.

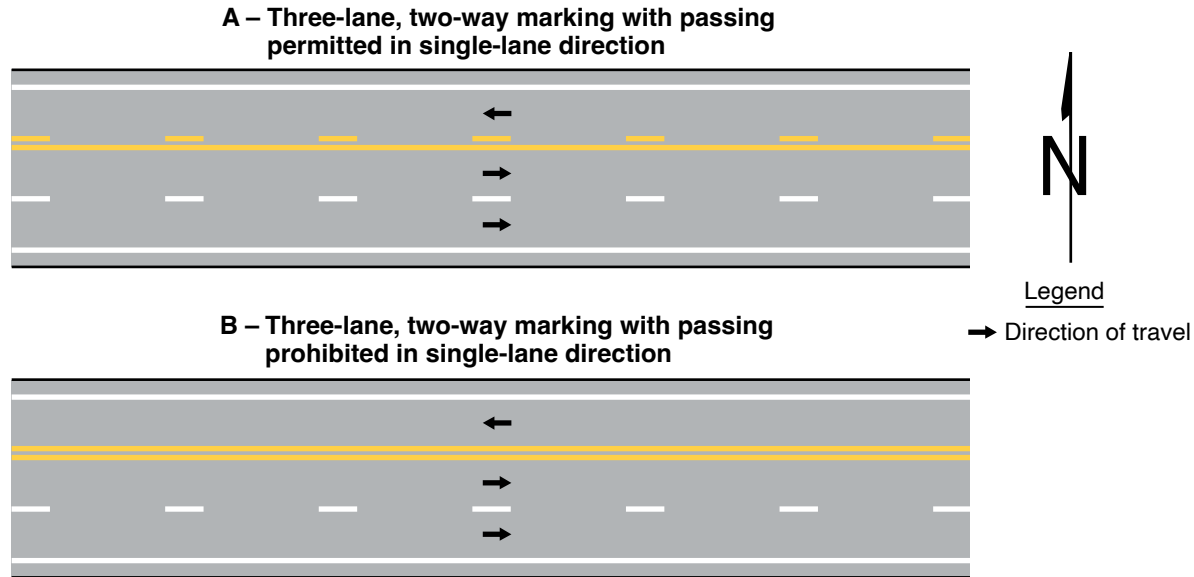
08 On two-way roadways with three through lanes for moving motor vehicle traffic, two lanes should be designated for traffic in one direction by using one-direction or two-direction no-passing zone markings as shown in Figure 3B-3.

**Figure 3B-1. Yellow Center Lines for Two-Lane, Two-Way Applications**



**Figure 3B-2. Yellow Center Lines for Four-or-More Lane, Two-Way Applications**



**Figure 3B-3. Yellow Center Lines for Three-Lane, Two-Way Applications****Section 3B.02 Warrants for Yellow Center Lines****Standard:**

- 01 Center line markings shall be placed on all paved undivided two-way urban arterials and collectors that have a traveled way of 20 feet or more in width and an ADT of 6,000 vehicles per day or greater. Center line markings shall also be placed on all paved undivided two-way streets or highways that have three or more lanes for moving motor vehicle traffic.

**Guidance:**

- 02 Center line markings should be placed on paved urban arterials and collectors that have a traveled way of 20 feet or more in width and an ADT of 4,000 vehicles per day or greater. Center line markings should also be placed on all rural arterials and collectors that have a traveled way of 18 feet or more in width and an ADT of 3,000 vehicles per day or greater. Center line markings should also be placed on other traveled ways where an engineering study indicates such a need.
- 03 Engineering judgment should be used in determining whether to place center line markings on traveled ways that are less than 16 feet wide because of the potential for traffic encroaching on the pavement edges, traffic being affected by parked vehicles, and traffic encroaching into the opposing traffic lane.

**Option:**

- 04 Center line markings may be placed on other paved two-way traveled ways that are 16 feet or more in width.
- 05 If a traffic count is not available, the ADTs described in this Section may be estimates that are based on engineering judgment.

**Section 3B.03 No-Passing Zone Pavement Markings****Standard:**

- 01 No-passing zones shall be marked by either the one-direction no-passing zone pavement markings or the two-direction no-passing zone pavement markings described in Section 3B.01 and shown in Figures 3B-1 and 3B-3.
- 02 No-passing zone markings shall be used on:
- A. Two-way roadways at lane-reduction transitions (see Section 3B.12),
  - B. Approaches to obstructions that must be passed on the right (see Section 3B.13),
  - C. Approaches to grade crossings (see Section 8C.02), and
  - D. Approaches to crosswalks.
- 03 On two-way, two-lane or three-lane roadways where center line markings are installed, no-passing zones shall be established at vertical and horizontal curves and other locations where an engineering study indicates that passing must be prohibited because of inadequate sight distances or other special conditions.

04 **On roadways with center line markings, no-passing zone markings shall be used at horizontal or vertical curves where the passing sight distance is less than the minimum shown in Table 3B-1 for the 85th-percentile speed or the speed limit.**

Support:

05 The passing sight distance on a vertical curve is the distance at which an object 3.5 feet above the pavement surface can be seen from a point 3.5 feet above the pavement (see Figure 3B-4). Similarly, the passing sight distance on a horizontal curve is the distance measured along the center line (or right-hand lane line of a three-lane roadway) between two points 3.5 feet above the pavement on a line tangent to the embankment or other obstruction that cuts off the view on the inside of the curve (see Figure 3B-4).

06 The upstream end of a no-passing zone at point “a” in Figure 3B-4 is that point where the sight distance first becomes less than that specified in Table 3B-1. The downstream end of the no-passing zone at point “b” in Figure 3B-4 is that point at which the sight distance again becomes greater than the minimum specified.

*Guidance:*

07 *Where the distance between successive no-passing zones is less than 400 feet, no-passing zone markings should connect the zones.*

Support:

08 No-passing zone signs (see Sections 2B.36, 2B.37, and 2C.53) are sometimes used to emphasize the existence and extent of a no-passing zone.

**Standard:**

09 **On three-lane roadways where the direction of travel in the center lane transitions from one direction to the other, a no-passing buffer zone, consisting of a flush median island (see Section 3J.03) at least 50 feet in length, shall be provided in the center lane as shown in Figure 3B-5. A lane-reduction transition (see Section 3B.12) shall be provided approaching each end of the buffer zone.**

**Section 3B.04 Yellow Pavement Markings for Reversible Lanes**

**Standard:**

01 **If reversible lanes are used, the lane line pavement markings on each side of reversible lanes shall consist of a normal width broken double yellow line to delineate the edge of a lane in which the direction of travel is reversed from time to time, such that each of these markings serve as the center line markings of the roadway during some period (see Figure 3B-6).**

02 **Signs (see Section 2B.34), lane-use control signals (see Chapter 4T), or both shall be used to supplement reversible lane pavement markings.**

Support:

03 Section 3E.02 contains additional applications of pavement markings for counter-flow preferential lanes that also operate as reversible lanes.

**Section 3B.05 Pavement Markings for Two-Way Left-Turn Lanes**

**Standard:**

01 **If a two-way left-turn lane that is never operated as a reversible lane is used, the lane line pavement markings on each side of the two-way left-turn lane shall consist of a normal width broken yellow line and a normal width solid yellow line to delineate the edges of a lane that can be used by traffic in either direction as part of a left-turn maneuver. These markings shall be placed with the broken line toward the two-way left-turn lane and the solid line toward the adjacent traffic lane as shown in Figure 3B-7.**

*Guidance:*

02 *White two-way left-turn lane-use arrows should be used at or just downstream from the beginning of a two-way left-turn lane.*

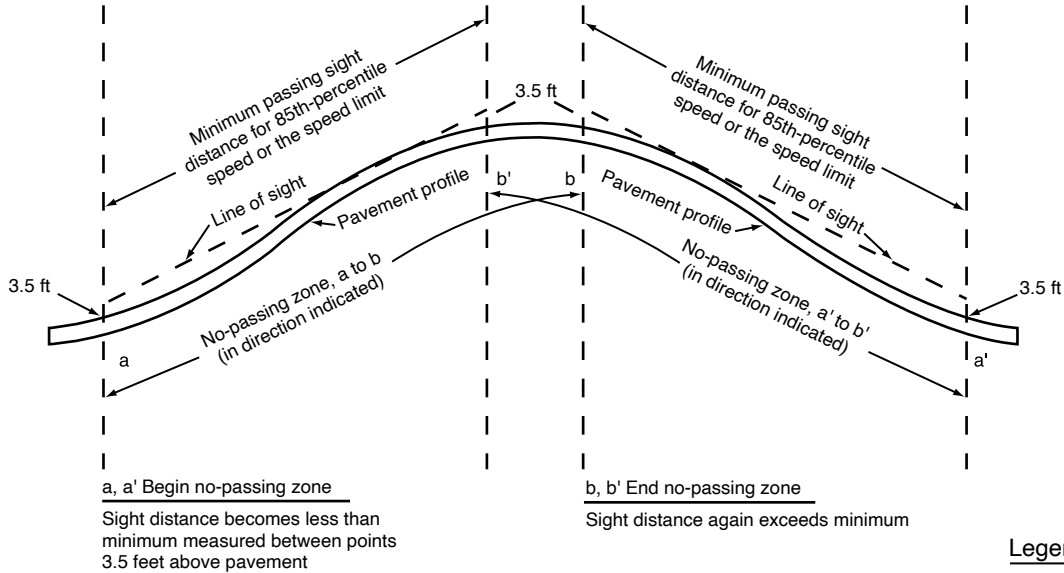
**Table 3B-1. Minimum Passing Sight Distances for No-Passing Zone Markings**

| 85th-Percentile or Speed Limit | Minimum Passing Sight Distance |
|--------------------------------|--------------------------------|
| 25 mph                         | 450 feet                       |
| 30 mph                         | 500 feet                       |
| 35 mph                         | 550 feet                       |
| 40 mph                         | 600 feet                       |
| 45 mph                         | 700 feet                       |
| 50 mph                         | 800 feet                       |
| 55 mph                         | 900 feet                       |
| 60 mph                         | 1,000 feet                     |
| 65 mph                         | 1,100 feet                     |
| 70 mph                         | 1,200 feet                     |



**Figure 3B-4. Method of Locating and Determining the Limits of No-Passing Zones at Curves**

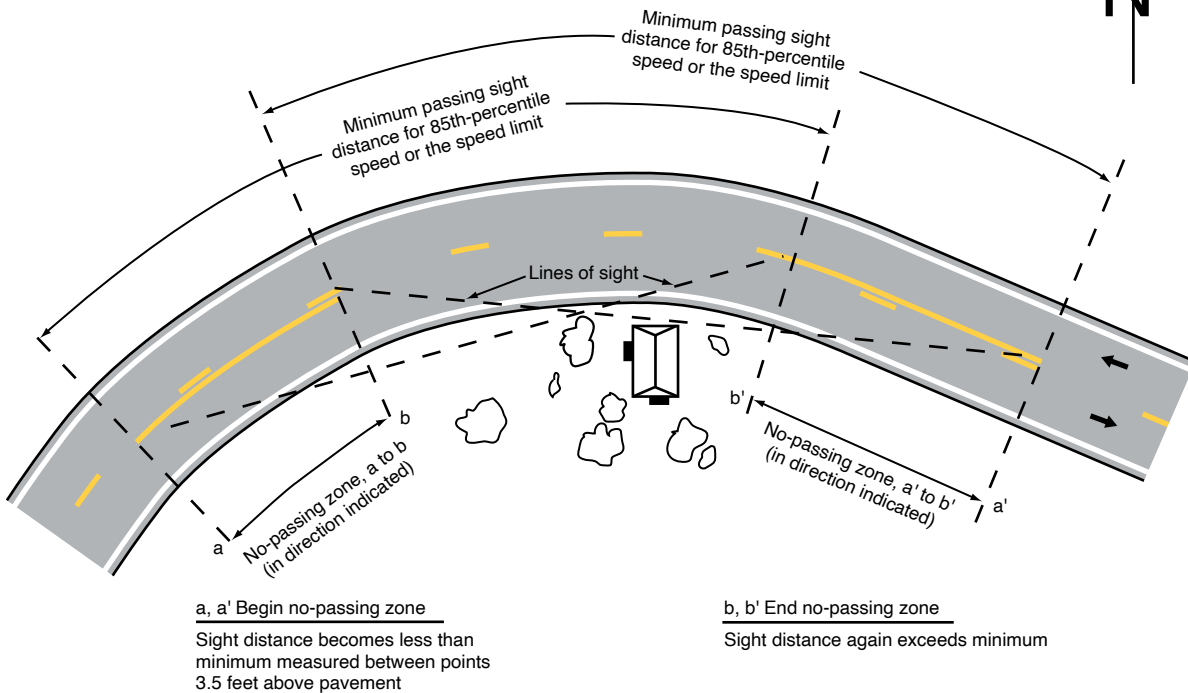
**A – No-passing zone at VERTICAL CURVE**



**Profile View**

Note: No-passing zones in opposite directions might or might not overlap, depending on alignment

**B – No-passing zone at HORIZONTAL CURVE**

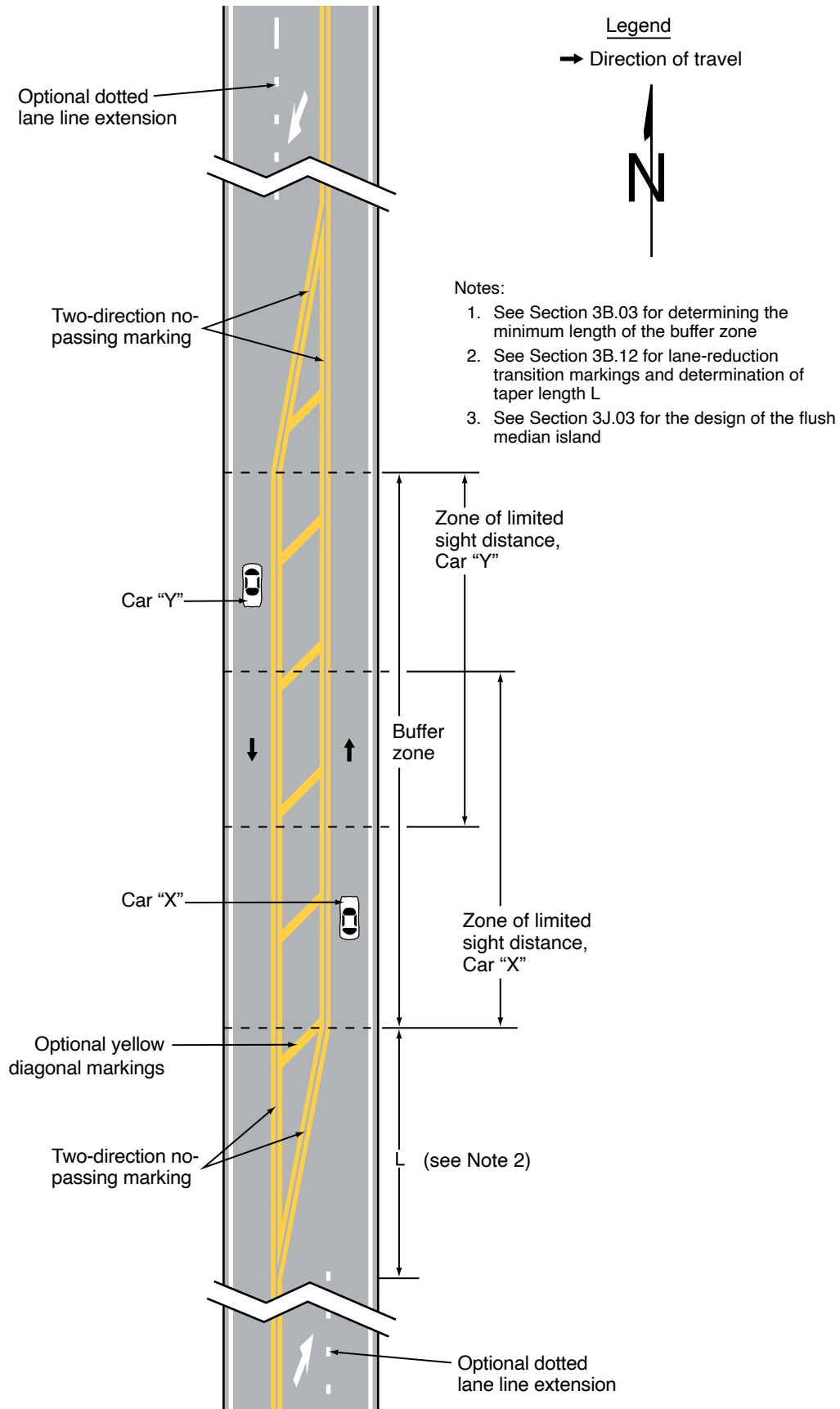


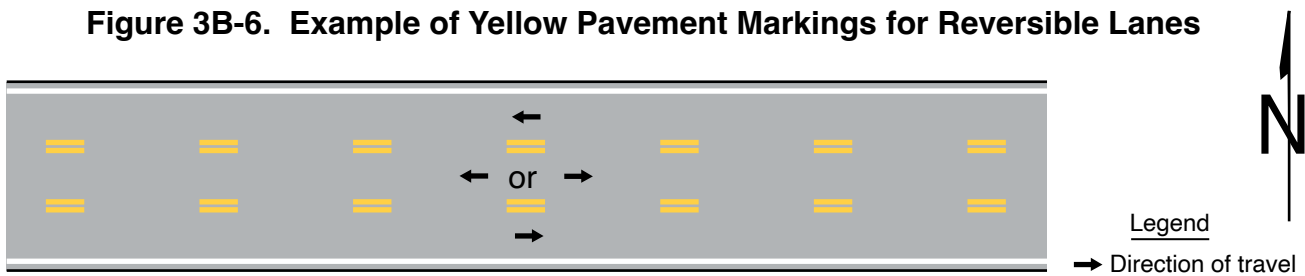
**Plan View**

Note: No-passing zones in opposite directions might or might not overlap, depending on alignment



**Figure 3B-5. Application of Three-Lane, Two-Way Markings for Changing the Direction of the Center Lane**



**Figure 3B-6. Example of Yellow Pavement Markings for Reversible Lanes****Option:**

- 03 Additional two-way left-turn lane-use arrow markings may be used at other locations along a two-way left-turn lane where engineering judgment determines that such additional markings are needed to emphasize the proper use of the lane.

**Standard:**

- 04 **A single-direction lane-use arrow shall not be used in a lane bordered on both sides by yellow two-way left-turn lane longitudinal markings.**

*Guidance:*

- 05 *Signs should be used in conjunction with the two-way left-turn markings (see Section 2B.32).*
- 06 *Two-way left-turn lane markings should not extend to intersections (see definition in Section 1C.02).*

**Option:**

- 07 Two-way left-turn lanes may be transitioned to mandatory left-turn lanes as shown in Figure 3B-7 or painted median islands where they approach an intersection.

**Support:**

- 08 Section 8A.06 contains guidance information for discontinuing a two-way left-turn lane in the immediate vicinity of a highway-rail or highway-LRT grade crossing.

**Section 3B.06 White Lane Line Pavement Markings****Standard:**

- 01 **When used, lane line pavement markings delineating the separation of traffic lanes that have the same direction of travel shall be white.**
- 02 **Lane line markings shall be used on all freeways and Interstate highways.**

*Guidance:*

- 03 *Lane line markings should be used:*
- A. *On all roadways that are intended to operate with two or more adjacent traffic lanes in the same direction of travel, except as otherwise required for reversible lanes.*
  - B. *At congested locations where the roadway will accommodate more traffic lanes with lane line markings than without the markings.*

**Support:**

- 04 Examples of lane line markings are shown in Figures 3B-2, 3B-3, and 3B-7 through 3B-13.

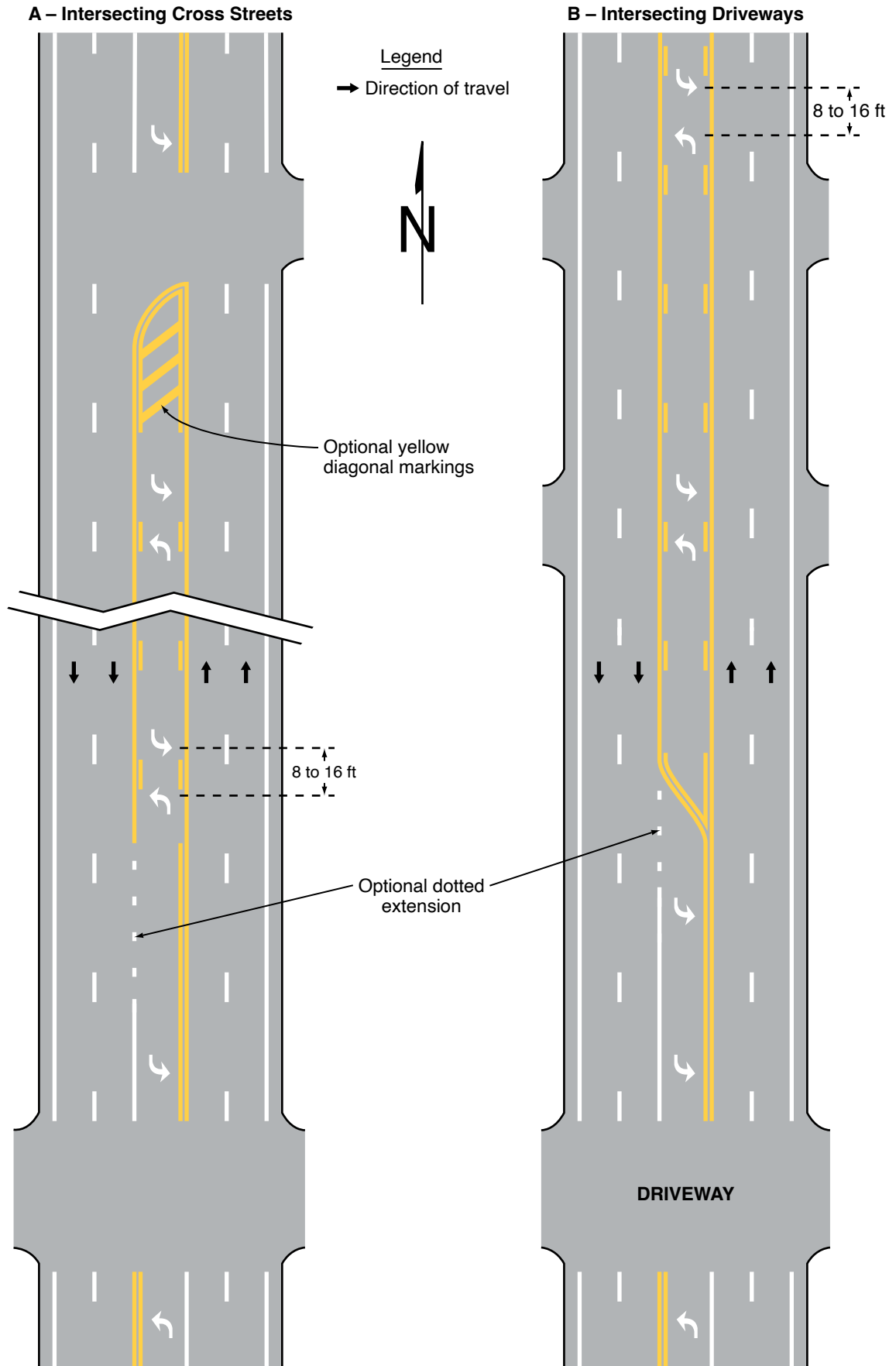
**Standard:**

- 05 **Except as provided in Paragraph 1 of Section 3B.07, where crossing the lane line markings with care is not discouraged or prohibited, the lane line markings shall consist of a normal width broken white line.**
- 06 **Where crossing the lane line markings is discouraged, the lane line markings shall consist of a normal width solid white line.**

*Guidance:*

- 07 *A solid white lane line marking should be used on approaches to:*
- A. *Intersections to separate a through lane from a mandatory turn lane.*
  - B. *Intersections to separate contiguous mandatory turn lanes from each other.*
  - C. *Toll collection points to separate toll lanes, payment methods, channelized movements, or obstructions.*

**Figure 3B-7. Examples of Two-Way Left-Turn Lane Marking Applications**



## Option:

- 08 Solid white lane line markings may be used:
- A. On approaches to intersections to separate contiguous through lanes.
  - B. To separate through traffic lanes from auxiliary lanes, such as an added uphill truck lane.
  - C. On approaches to crosswalks across multi-lane roadways.
- 09 Wide solid white lane line markings may be used for greater emphasis.
- 10 A curved transition may be used where an edge line, channelizing line, or dotted extension line changes direction.

## Support:

- 11 Examples of locations where a curved transition can have value include freeway exit and entrance ramps, and turn lanes.

## Standard:

- 12 Where crossing the lane line markings is prohibited, the lane line markings shall consist of a double solid white line (see Figure 3B-8).

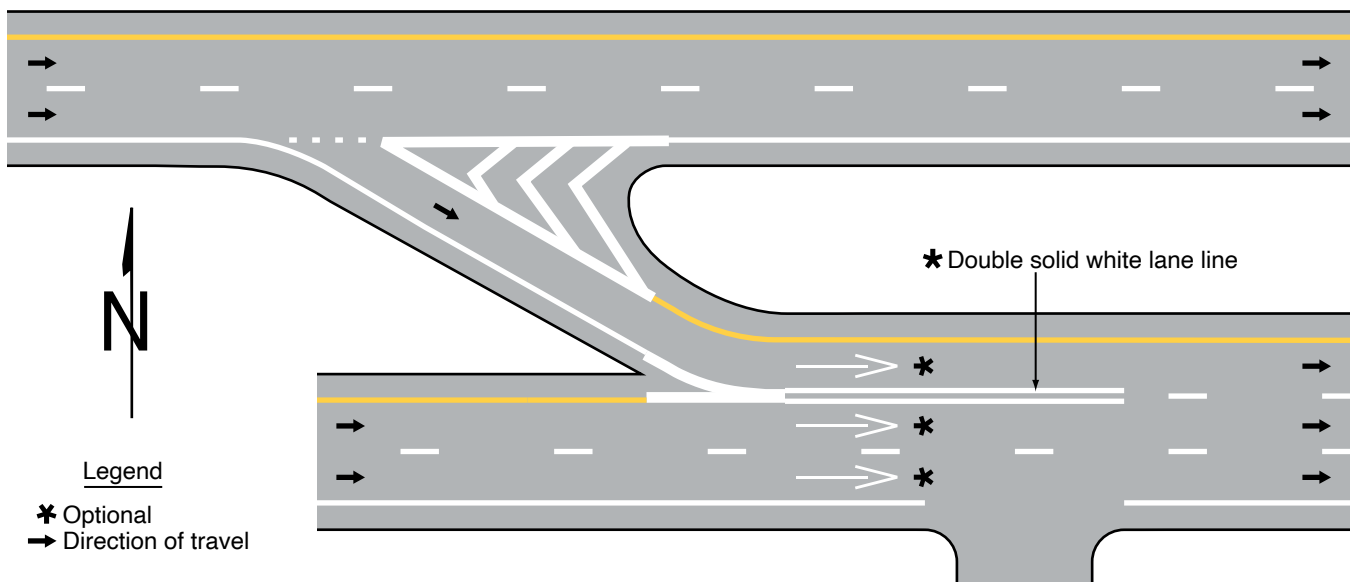
**Section 3B.07 White Lane Line Markings for Non-Continuing Lanes**

## Standard:

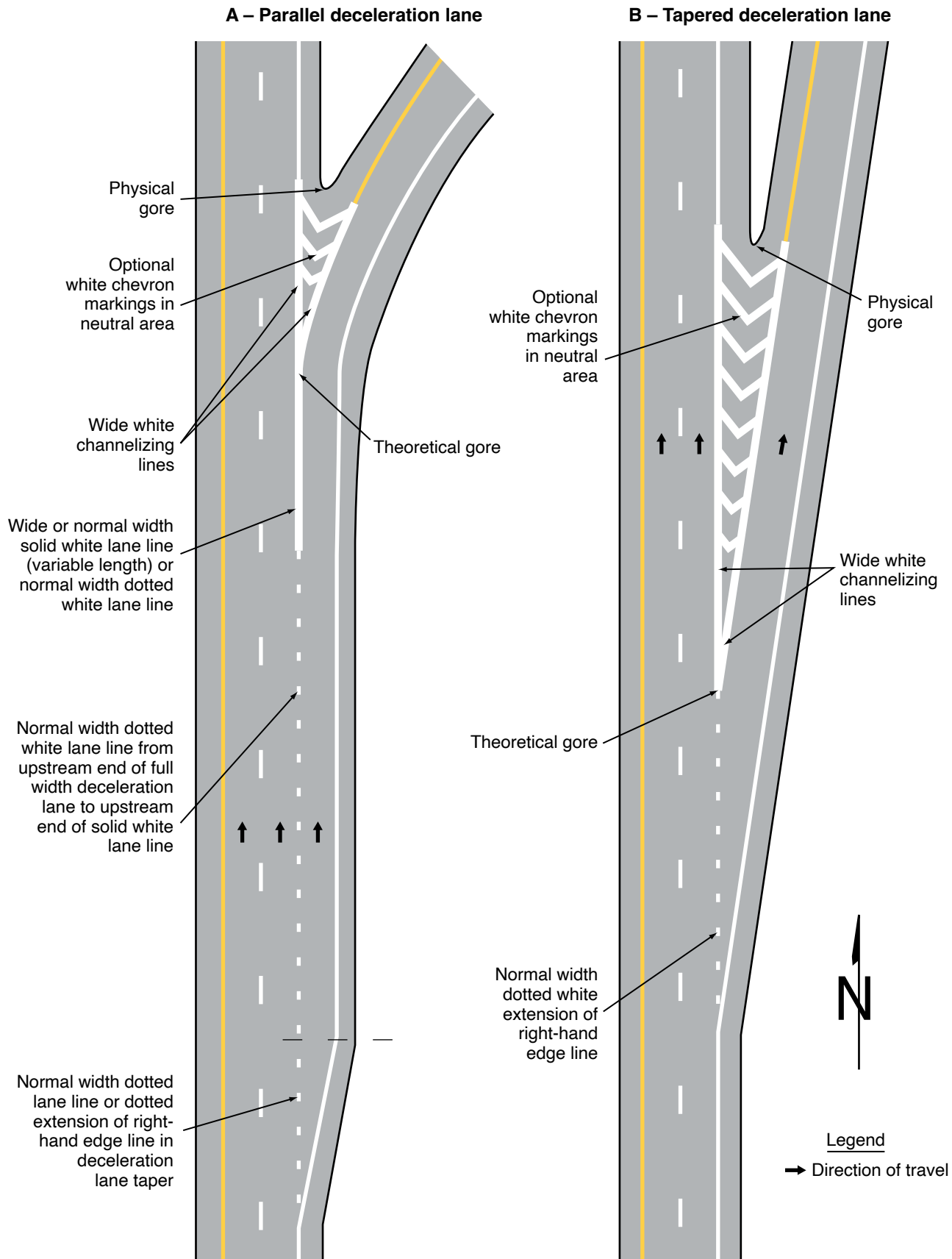
- 01 A normal width dotted white line marking shall be used as the lane line to separate a through lane that continues beyond the interchange or intersection from an adjacent deceleration or acceleration lane.
- 02 For exit ramps with a parallel deceleration lane, a normal width dotted white lane line extension shall be installed from the upstream end of the taper to the theoretical gore or to the upstream end of a solid white lane line, if used, that extends upstream from the theoretical gore as shown in Drawings A and C in Figure 3B-9.
- 03 For an exit ramp with a tapered deceleration lane, a normal width dotted white line extension shall be installed from the theoretical gore through the taper area such that it meets the edge line at the upstream end of the taper as shown in Drawing B in Figure 3B-9.
- 04 For entrance ramps with a parallel acceleration lane, a normal width dotted white lane line shall be installed from the theoretical gore or from the downstream end of a solid white lane line, if used, that extends downstream from the theoretical gore, to a point at least one-half the distance from the theoretical gore to the downstream end of the acceleration taper, as shown in Drawing A in Figure 3B-10.

## Option:

- 05 For entrance ramps with a parallel acceleration lane, a normal width dotted white line extension may be installed from the downstream end of the dotted white lane line to the downstream end of the acceleration taper, as shown in Drawing A in Figure 3B-10.

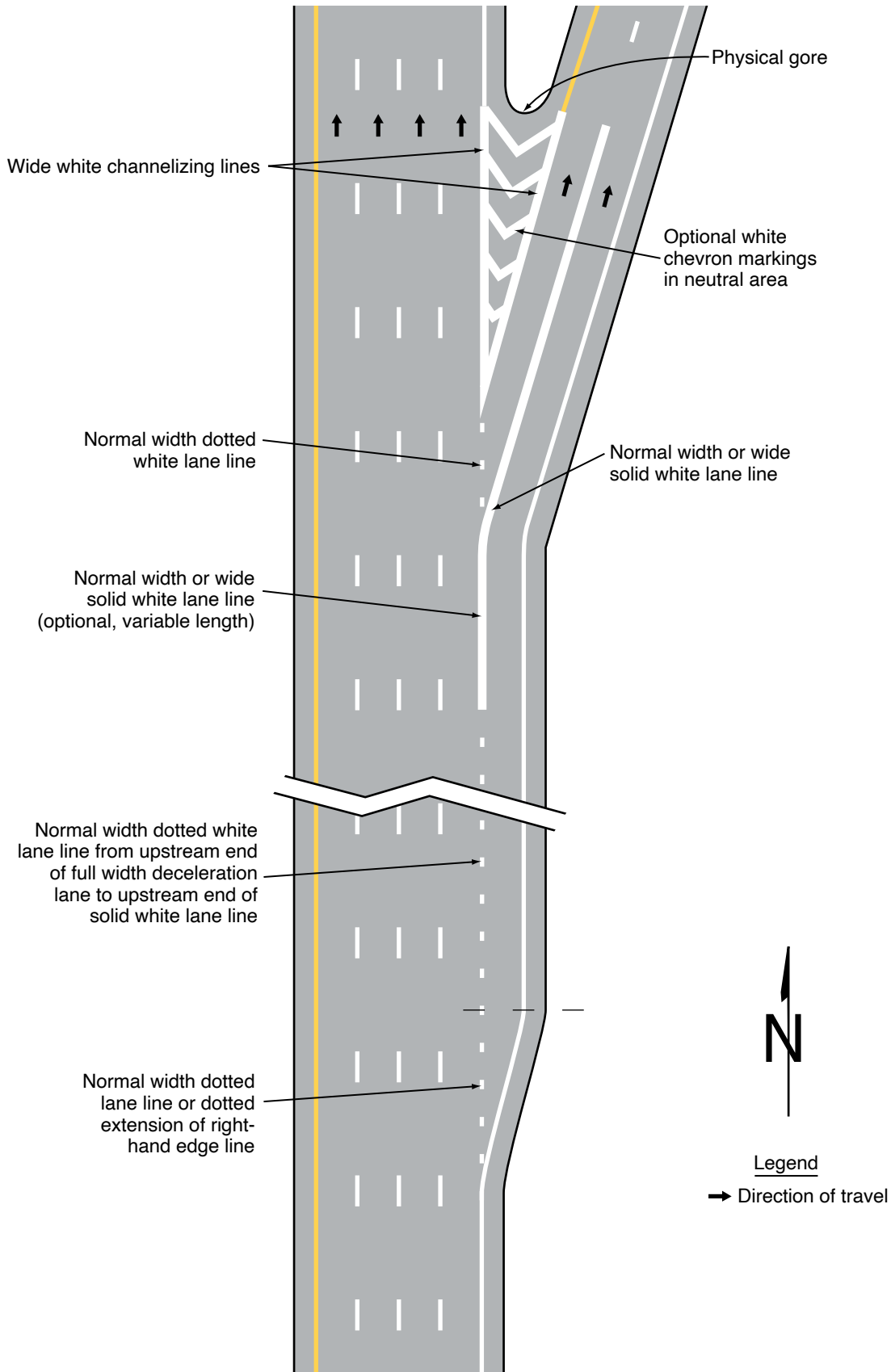
**Figure 3B-8. Example of a Double Solid White Line Used to Prohibit Lane Changing**

**Figure 3B-9. Examples of Dotted Line and Channelizing Line Applications for Exit Ramp Markings (Sheet 1 of 2)**

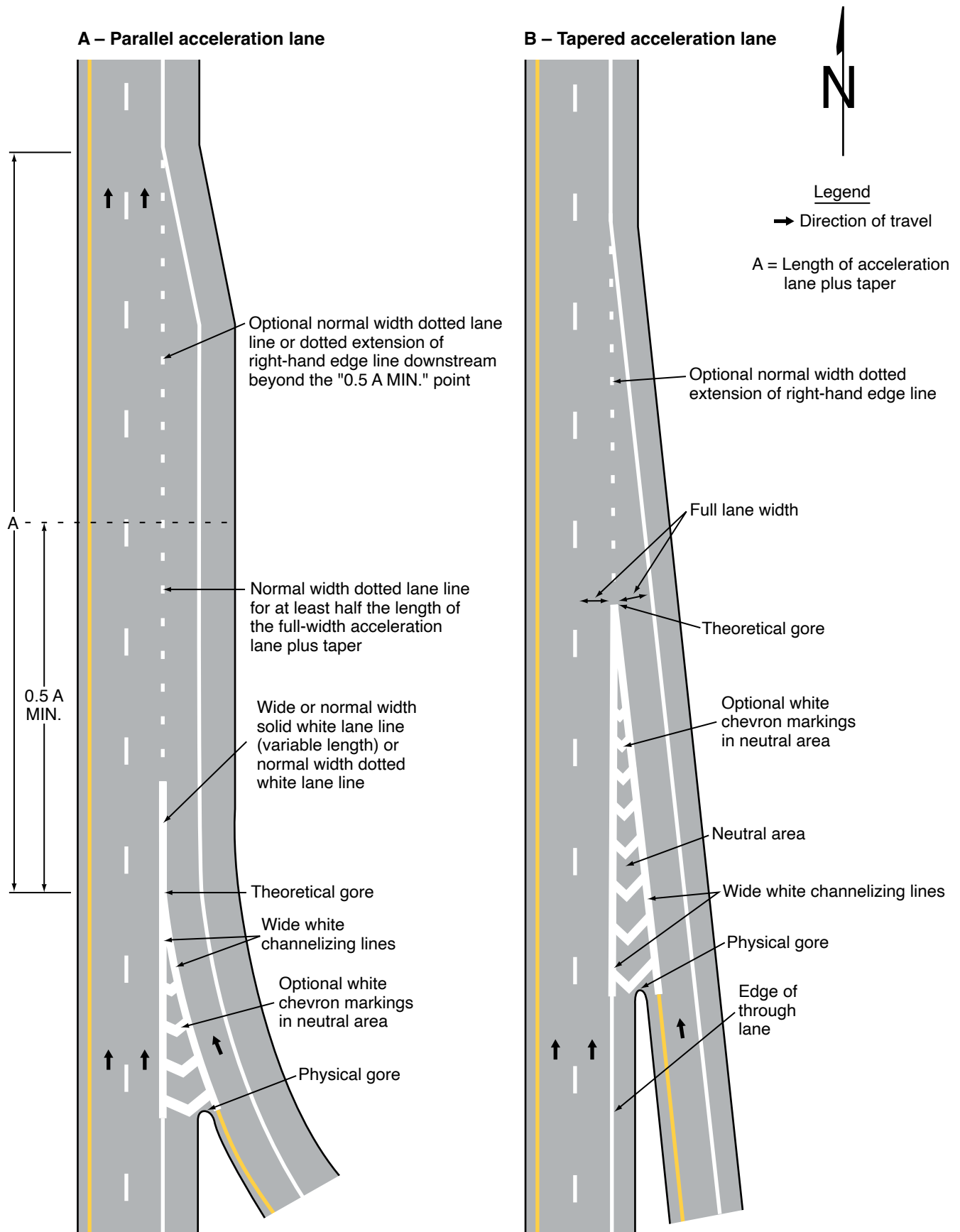


### Figure 3B-9. Examples of Dotted Line and Channelizing Line Applications for Exit Ramp Markings (Sheet 2 of 2)

C – Parallel deceleration lane at a multi-lane exit ramp having an optional exit lane that also carries the through route



**Figure 3B-10. Examples of Dotted Line and Channelizing Line Applications for Entrance Ramp Markings (Sheet 1 of 2)**







- 06 For entrance ramps with a tapered acceleration lane, a normal width dotted white line extension may be installed from the downstream end of the channelizing line adjacent to the through lane to the downstream end of the acceleration taper, as shown in Drawings B and C in Figure 3B-10.

**Standard:**

- 07 **A wide dotted white lane line shall be used:**

- A. As a lane drop marking in advance of lane drops at exit ramps to distinguish a lane drop from a normal exit ramp (see Drawings A, B, and C in Figure 3B-11),
- B. In advance of freeway route splits with dedicated lanes (see Drawing D in Figure 3B-11),
- C. In advance of freeway route splits with an option lane (see Drawing E in Figure 3B-11),
- D. To separate a through lane that continues beyond an interchange from an adjacent continuous auxiliary lane between an entrance ramp and an exit ramp (see Drawing F in Figure 3B-11),
- E. As a lane drop marking in advance of lane drops at intersections to distinguish a lane drop from an intersection through lane (see Drawing A in Figure 3B-12), and
- F. To separate a through lane that continues beyond an intersection from an adjacent auxiliary lane between two intersections (see Drawing B in Figure 3B-12).

*Guidance:*

- 08 *Lane drop markings used in advance of lane drops at freeway and expressway exit ramps should begin at least ½ mile in advance of the theoretical gore.*
- 09 *On the approach to a multi-lane exit ramp having an optional exit lane that also carries through traffic, lane line markings should be used as illustrated in Drawing B in Figure 3B-11.*
- 10 *Lane drop markings used in advance of lane drops at intersections should begin a distance in advance of the intersection that is determined by engineering judgment as suitable to enable drivers who do not desire to make the mandatory turn to move out of the lane being dropped prior to reaching the queue of vehicles that are waiting to make the turn. The lane drop markings should begin no closer to the intersection than the most upstream regulatory or warning sign associated with the lane drop.*
- 11 *The dotted white lane lines that are used for lane drop markings and that are used as a lane line separating through lanes from auxiliary lanes should consist of line segments that are 3 feet in length separated by 9-foot gaps.*

*Support:*

- 12 Sections 3B.21 and 3B.23 contain information regarding other markings that are associated with lane drops, such as ONLY word pavement markings and lane-use arrows.
- 13 Section 3B.12 contains information about the lane line markings that are to be used for transition areas where the number of through lanes is reduced at a location that is not at an interchange or intersection.

*Option:*

- 14 In the case of a lane drop at an exit ramp or intersection, a solid white line may replace a portion, but not all of the length, of the wide dotted white lane line.

### **Section 3B.08 Channelizing Lines**

*Support:*

- 01 Channelizing lines are used to form neutral areas where traffic traveling in the same general direction is permitted on both sides including entrance and exit ramps, access and egress points to and from managed lanes, toll-plaza bypasses, and left-turn lanes separated from through lanes. Channelizing lines are also sometimes used to alter travel paths for speed management or other purposes.
- 02 Chapter 3J contains information for the application of channelizing lines used in conjunction with islands.

**Standard:**

- 03 **Except as provided in Section 3E.04 and Paragraph 6 of Section 3J.05, a channelizing line shall be a solid wide or double solid white line.**

*Support:*

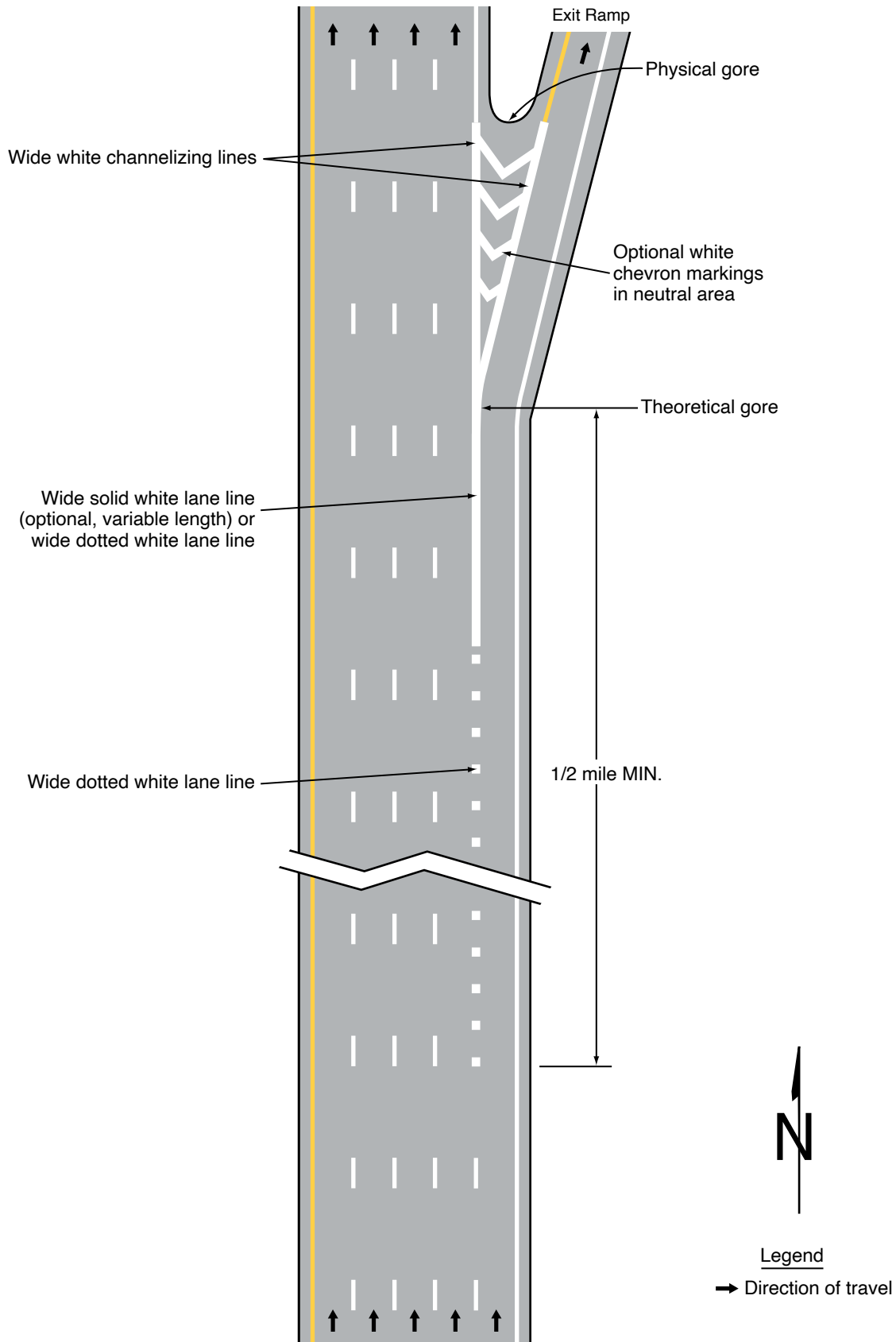
- 04 Examples of channelizing line applications are shown in Figures 3B-9, 3B-10, 3B-11, Drawing C in Figure 3B-15, Figures 3J-1 through 3J-5, and Drawing B in Figure 3J-6.

**Standard:**

- 05 **For all exit ramps and for entrance ramps with parallel acceleration lanes, channelizing lines shall be placed on both sides of the neutral area (see Figures 3B-9 and 3B-11 and Drawing A in Figure 3B-10).**

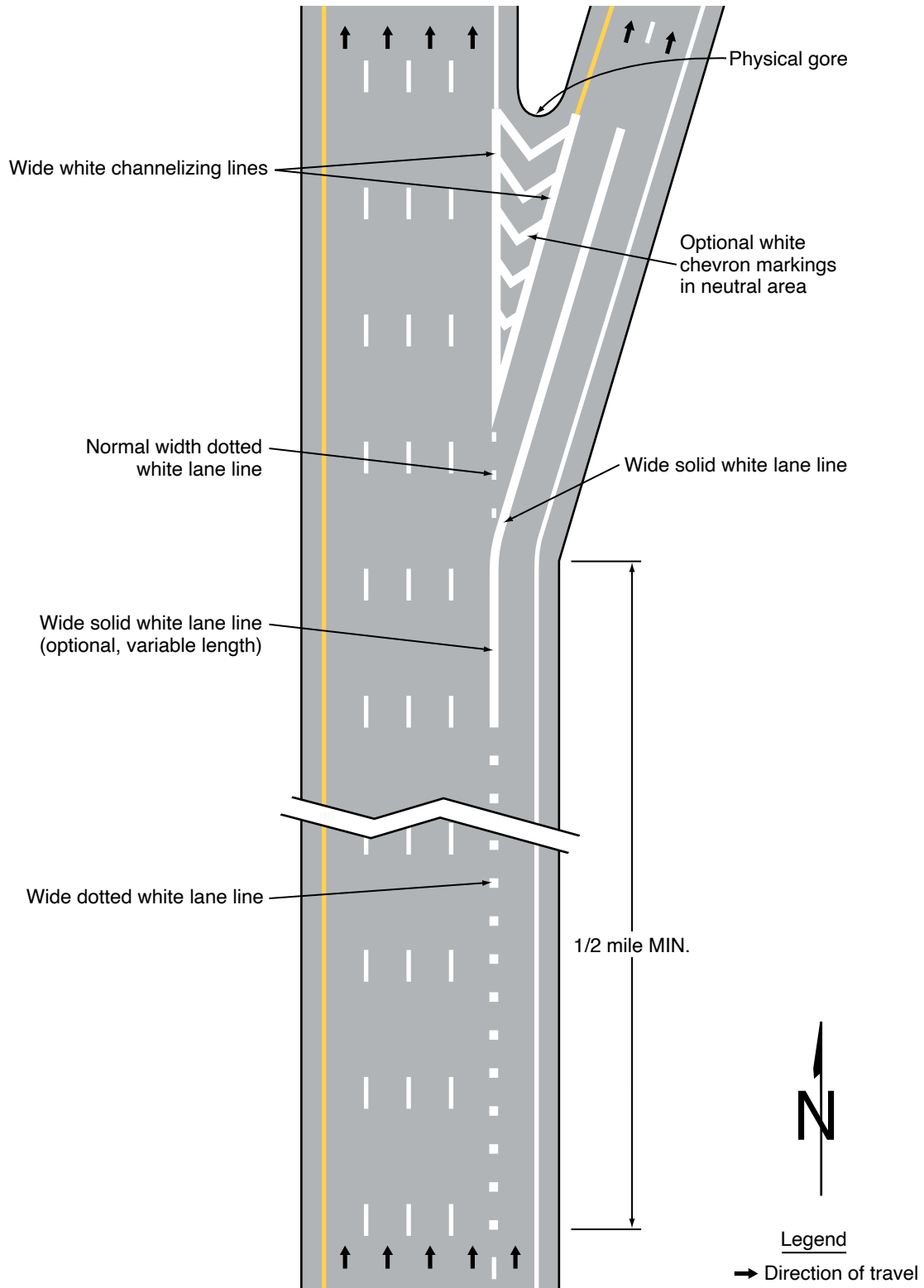
### Figure 3B-11. Examples of Applications of Freeway and Expressway Lane-Drop Markings (Sheet 1 of 6)

#### A – Lane drop at a single lane exit ramp

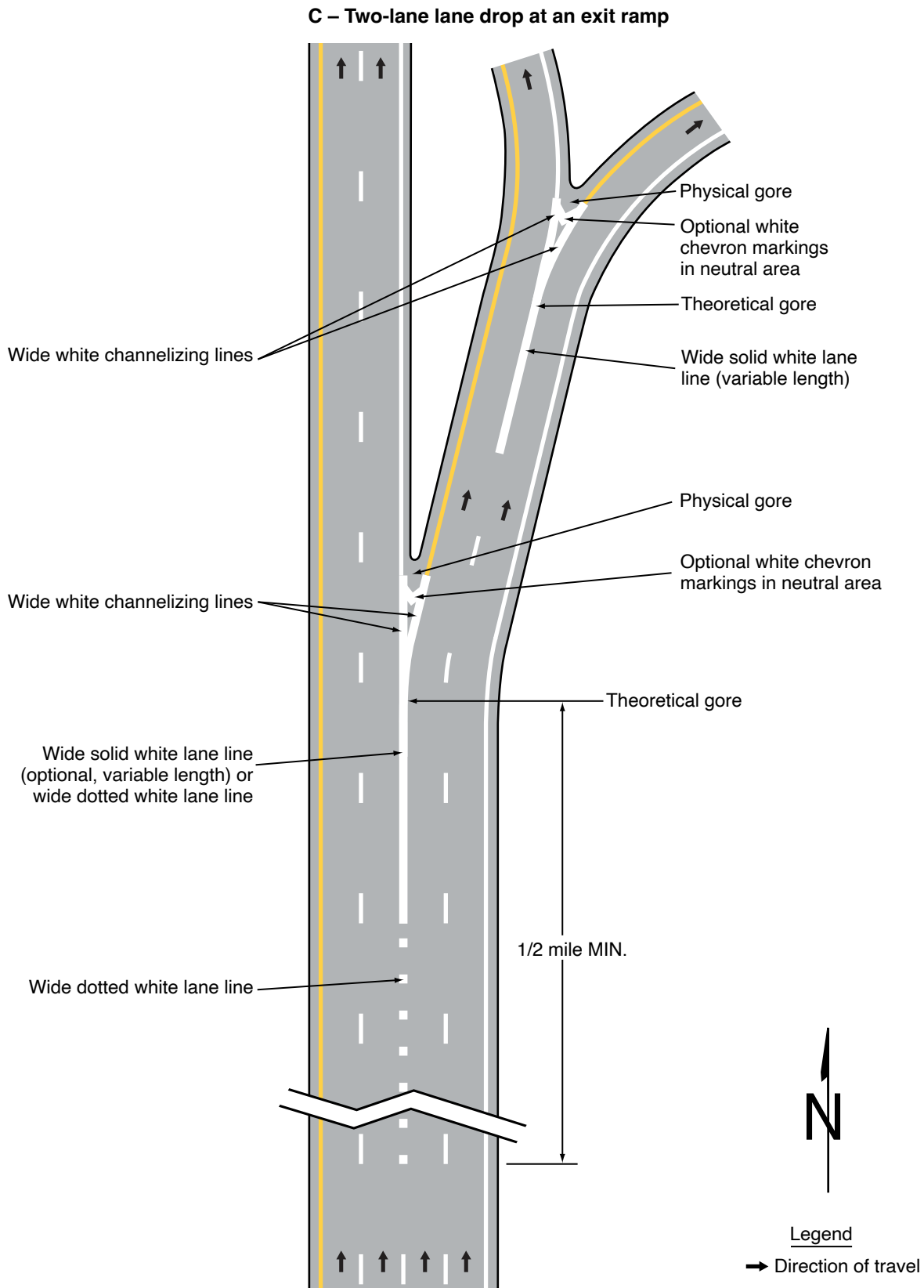


### Figure 3B-11. Examples of Applications of Freeway and Expressway Lane-Drop Markings (Sheet 2 of 6)

**B – Lane drop at a multi-lane exit ramp having an optional exit lane that also carries the through route**

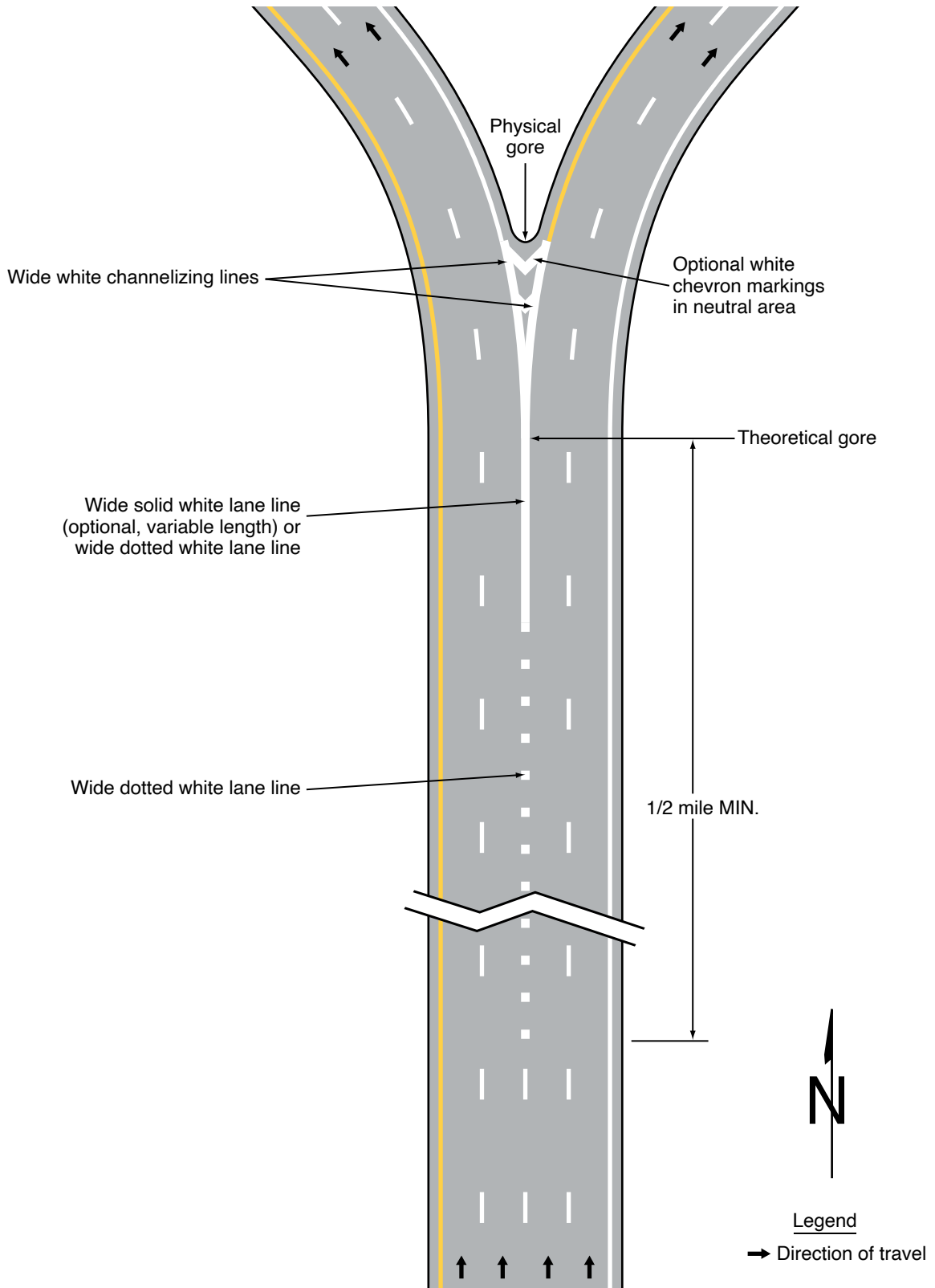


**Figure 3B-11. Examples of Applications of Freeway and Expressway Lane-Drop Markings (Sheet 3 of 6)**

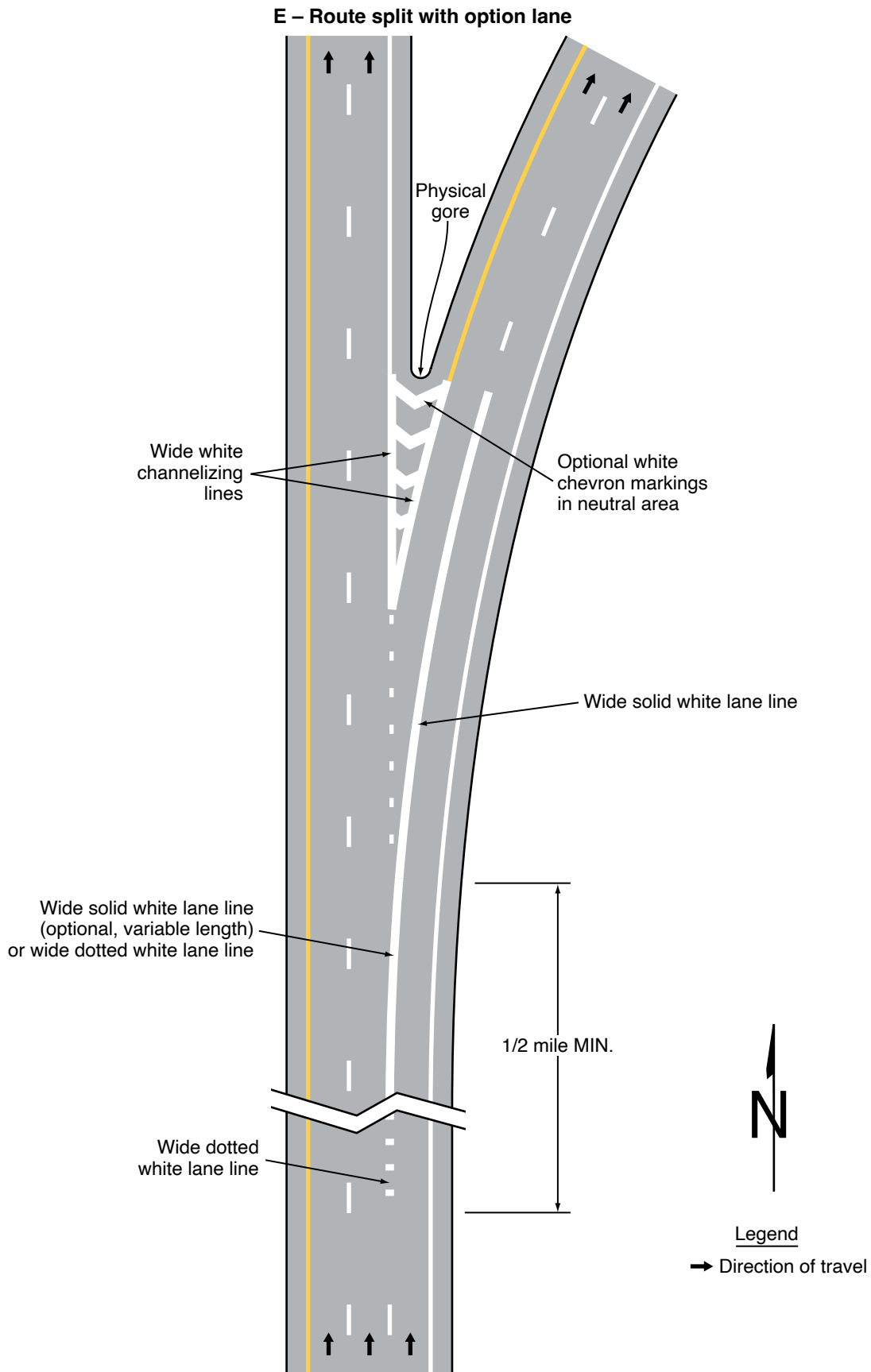


**Figure 3B-11. Examples of Applications of Freeway and Expressway Lane-Drop Markings (Sheet 4 of 6)**

**D – Route split with dedicated lanes**

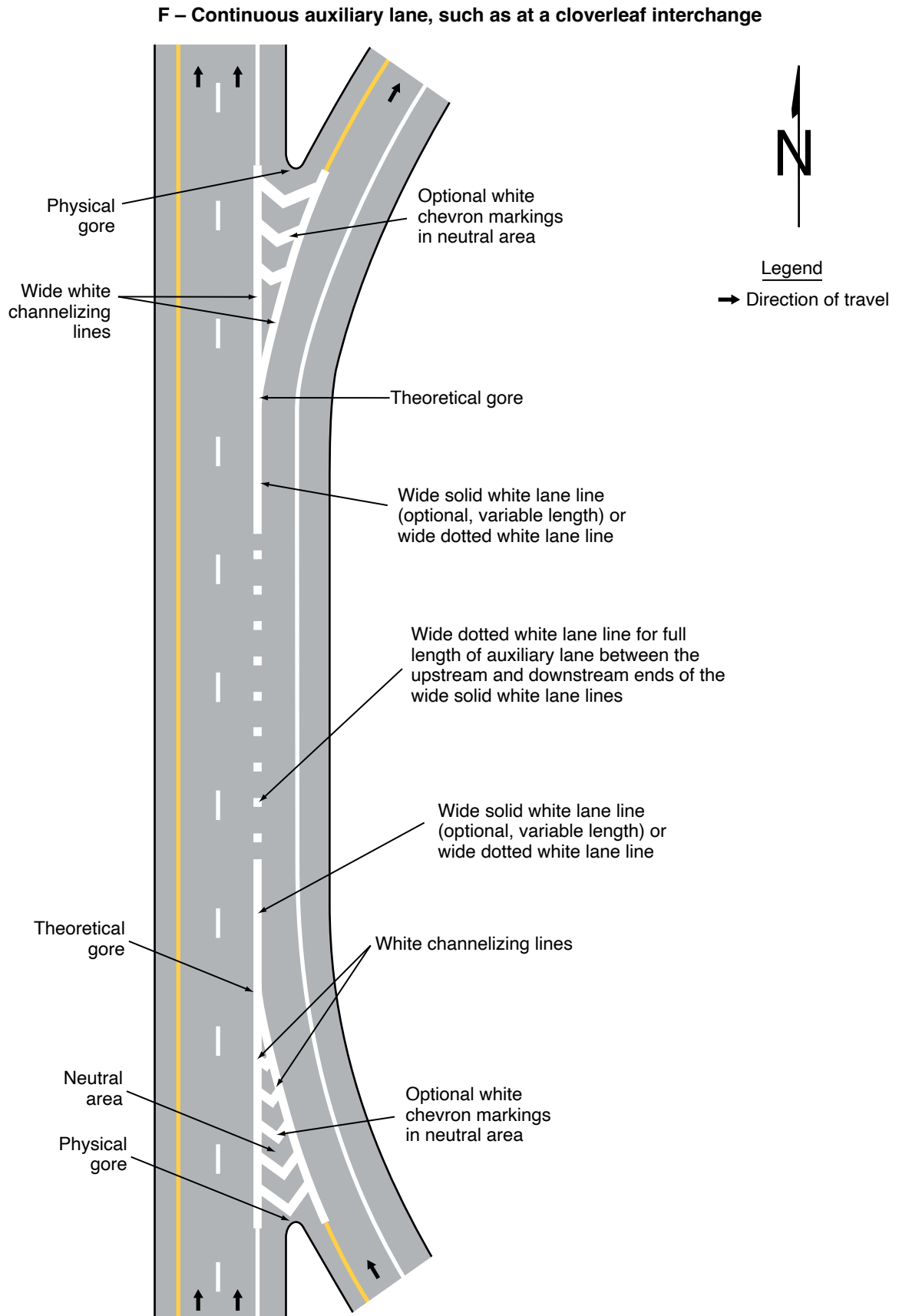


**Figure 3B-11. Examples of Applications of Freeway and Expressway Lane-Drop Markings (Sheet 5 of 6)**



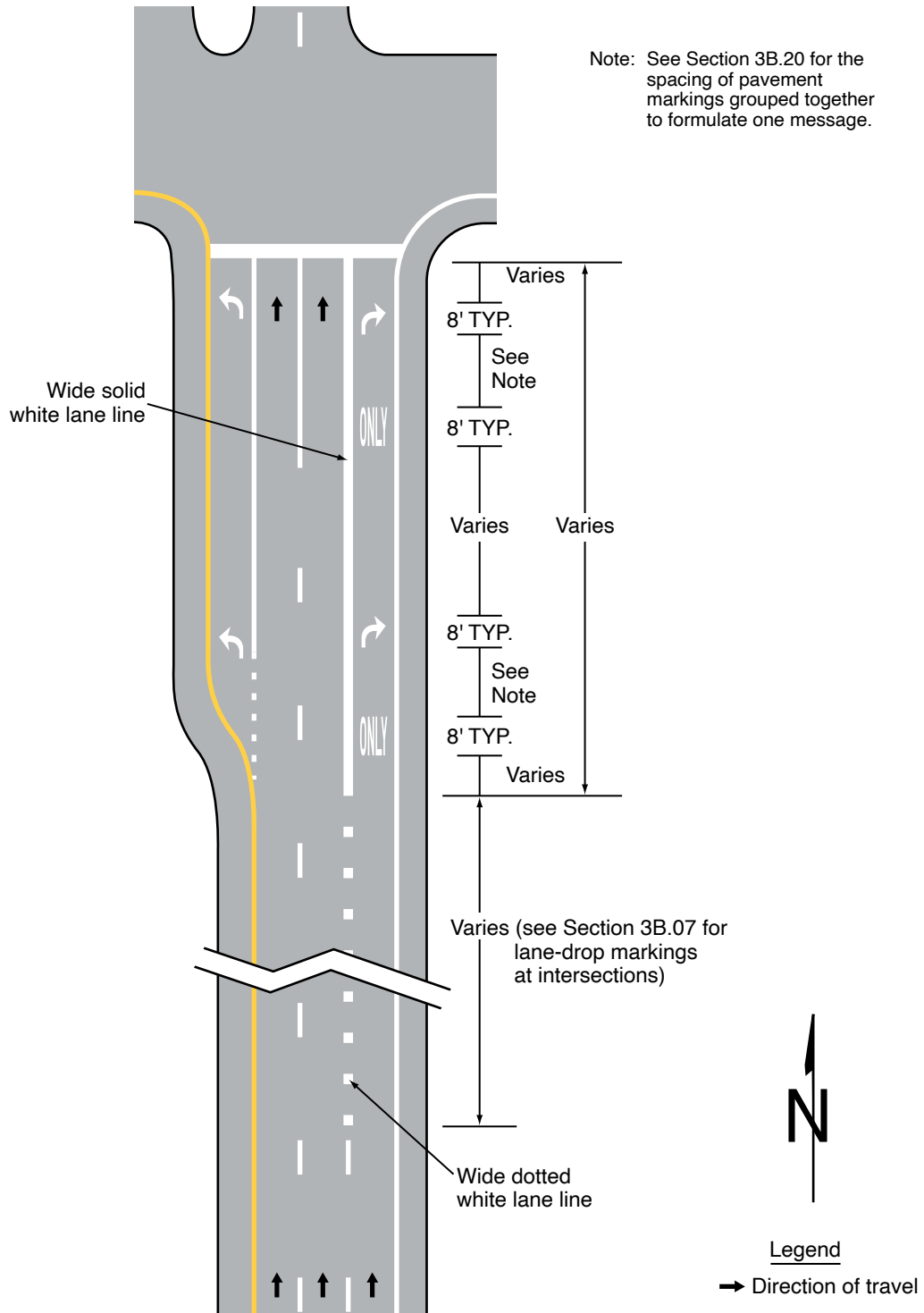


**Figure 3B-11. Examples of Applications of Freeway and Expressway Lane-Drop Markings (Sheet 6 of 6)**



**Figure 3B-12. Examples of Applications of Conventional Road Lane-Drop Markings**  
(Sheet 1 of 2)

**A – Lane drop at an intersection**





06 For entrance ramps with tapered acceleration lanes, channelizing lines shall be placed along both sides of the neutral area to a point at least one-half of the distance to the theoretical gore (see Drawing C in Figure 3B-10).

07 Channelizing lines shall be placed on both sides of the neutral area for bifurcations created from open-road tolling lanes that bypass a conventional toll plaza.

08 Where neutral areas are formed at access and egress points to and from a managed-lane facility, channelizing lines shall be placed on both sides of the neutral area (see Figures 2G-8, 2G-10, 2G-13, 2G-16, 2G-22, 2G-23, 2G-27, and 2G-28).

Option:

09 For entrance ramps with tapered acceleration lanes, the channelizing lines may extend to the theoretical gore as shown in Drawing B in Figure 3B-10.

**Standard:**

10 Other pavement markings in the neutral area shall be white.

Support:

11 Pavement markings within the neutral area include chevron markings (see Section 3B.25), retroreflective raised pavement markers (see Section 3B.16), and internally illuminated raised pavement markers (see Section 3B.16).

### Section 3B.09 Edge Line Pavement Markings

**Standard:**

01 If used, edge line pavement markings shall delineate the right or left edges of a roadway.

02 Except as provided in Section 3E.04, right edge line pavement markings, if used, shall consist of a normal width solid white line to delineate the right-hand edge of the roadway.

03 If used on the roadways of divided highways or one-way streets, or on any ramp in the direction of travel, left edge line pavement markings shall consist of a normal width solid yellow line to delineate the left-hand edge of a roadway or to indicate driving or passing restrictions left of these markings, except as provided in Section 3E.04.

Support:

04 Edge line markings provide visual references to guide road users during adverse weather and visibility conditions.

Option:

05 Wide solid edge line markings may be used for greater emphasis.

Support:

06 Increasing edge line width from 4 inches to at least 6 inches can be a beneficial countermeasure on all facility types in both urban and rural areas.

*Guidance:*

07 Edge line markings should not be continued through intersections, except for the following situations:

- A. Dotted edge line extensions (see Section 3B.11), or
- B. Through that part of an intersection with no intersection approach (such as the far side of a T-intersection).

Support:

08 Section 3B.11 contains information on the use and application of edge lines through intersections, interchanges, and driveways.

### Section 3B.10 Warrants for Use of Edge Lines

**Standard:**

01 Edge line markings shall be placed on paved streets or highways with the following characteristics:

- A. Freeways,
- B. Expressways, and
- C. Rural arterials with a traveled way of 20 feet or more in width and an ADT of 6,000 vehicles per day or greater.

*Guidance:*

- 02 *Edge line markings should be placed on paved streets or highways with the following characteristics:*
- A. *Rural arterials and collectors with a traveled way of 20 feet or more in width and an ADT of 3,000 vehicles per day or greater.*
  - B. *On other paved streets and highways where an engineering study indicates a need for edge line markings.*
- 03 *Edge line markings should not be placed where an engineering study or engineering judgment indicates that providing them is likely to decrease safety for all road users.*

*Option:*

- 04 *Edge line markings may be placed on streets and highways with or without center line markings.*
- 05 *Edge line markings may be excluded, based on engineering judgment, for reasons such as if the traveled way edges are delineated by curbs, parking, or other markings.*
- 06 *If a bicycle lane is marked on the outside portion of the traveled way, the edge line that would mark the outside edge of the bicycle lane may be omitted.*
- 07 *Edge line markings may be used where edge delineation is desirable to minimize unnecessary driving on paved shoulders or on refuge areas that have lesser structural pavement strength than the adjacent roadway.*

**Section 3B.11 Application of Pavement Markings through Intersections or Interchanges****Standard:**

- 01 **Pavement markings extended into or continued through an intersection or interchange area shall be the same color as the line markings they extend (see Figure 3B-13).**

*Guidance:*

- 02 *Pavement markings extended into or continued through an intersection or interchange area should be at least the same width as the line markings they extend.*
- 03 *Where highway design or reduced visibility conditions make it desirable to provide control or to guide vehicles through an intersection or interchange, such as at offset, skewed, complex, or multi-leg intersections, on curved roadways, where multiple turn lanes are used, or where offset left-turn lanes might cause driver confusion, dotted lane line extension markings consisting of 2-foot line segments and 2-foot to 6-foot gaps should be used to extend longitudinal line markings through an intersection or interchange area.*
- 04 *Where greater restriction is preferred, solid lane lines or channelizing lines should be extended into or continued through intersections.*

**Standard:**

- 05 **Extensions of center lines through intersections shall be dotted lines.**

*Guidance:*

- 06 *Where a double line is extended through an intersection, a single line of equal width to one of the lines of the double line should be used.*

**Standard:**

- 07 **Solid lines shall not be used to extend edge lines into or through intersections except through that part of an intersection with no intersecting approach (such as at the far side of a T-intersection).**

*Guidance:*

- 08 *Edge line markings should be discontinued across intersecting approaches at intersections or interchanges.*
- 09 *Driveways that do not meet the definition of an intersection (see Section 1C.02) should have edge line markings maintained across the intersecting approach of the driveway.*

*Option:*

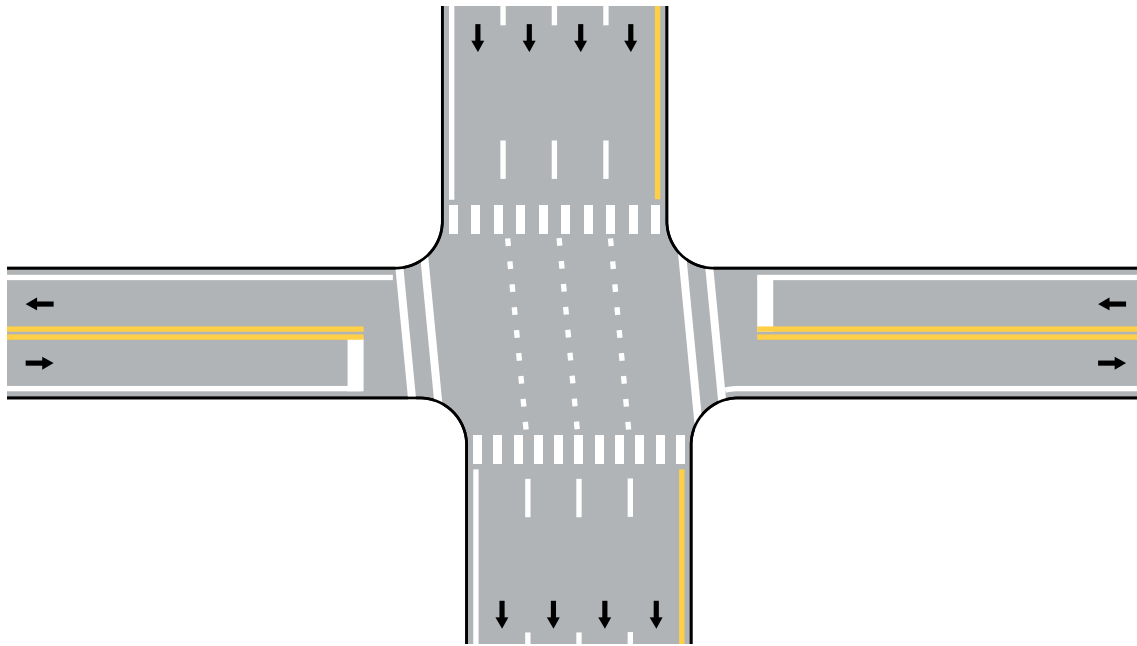
- 10 *Dotted edge line extensions may be placed through intersections.*

*Support:*

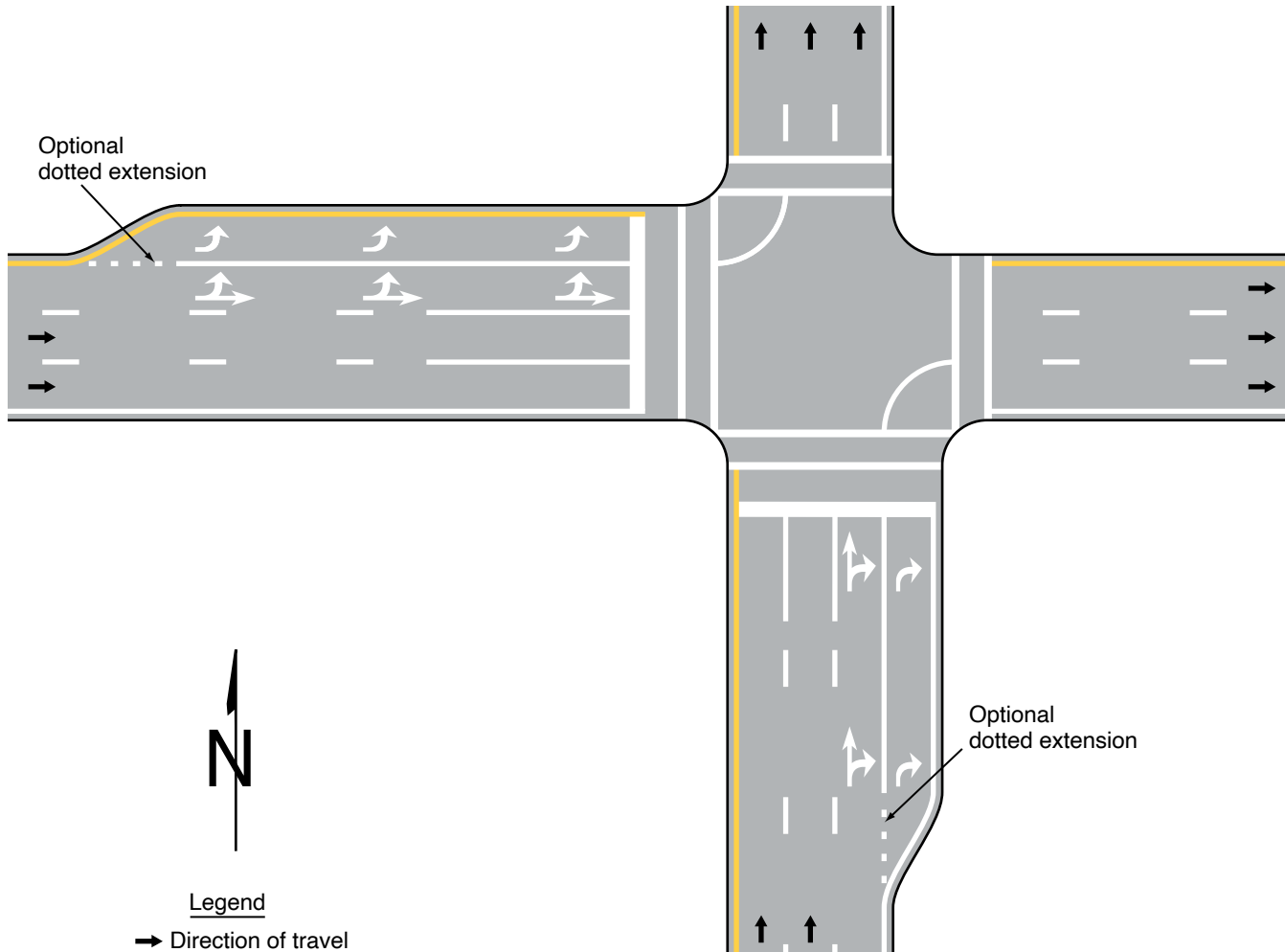
- 11 *Section 3B.31 contains information about edge lines through diverging diamond interchanges with a transposed alignment crossroad.*
- 12 *Section 3D.03 provides information for edge lines through roundabouts.*
- 13 *Section 5B.02 contains information on edge line extensions for driving automation system considerations.*
- 14 *Section 8C.05 contains information about the extension of edge lines through grade crossing areas.*
- 15 *Section 9E.03 contains information for the extensions of bicycle lanes through intersections.*

### Figure 3B-13. Examples of Line Extensions through Intersections (Sheet 1 of 2)

A – Typical pavement markings with offset lane lines continued through the intersection

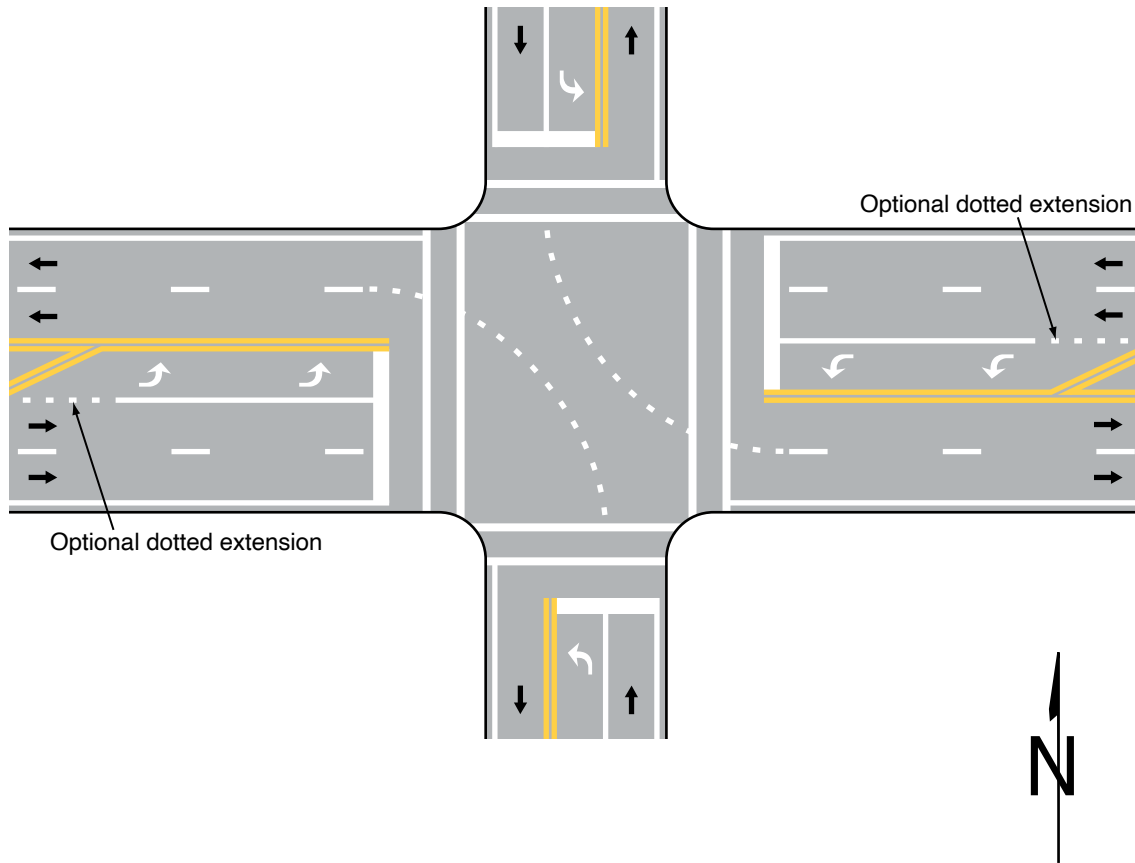


B – Typical pavement markings with line extensions into intersection for double turns

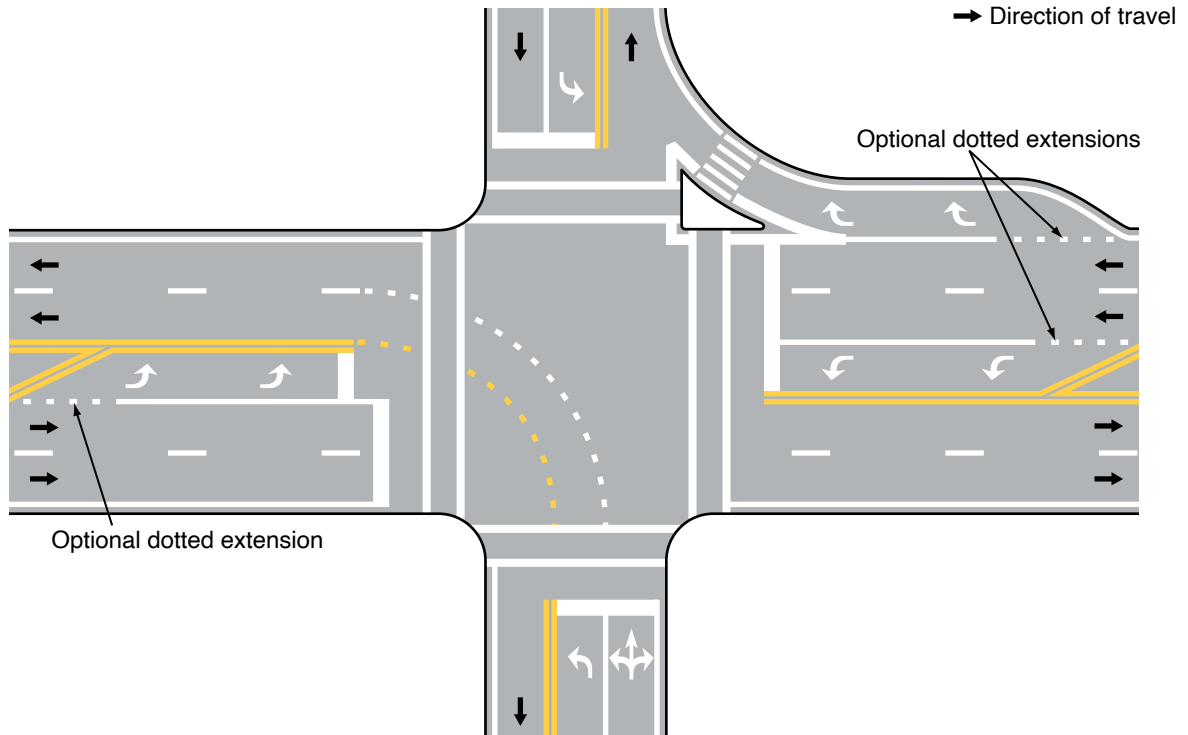


**Figure 3B-13. Examples of Line Extensions through Intersections (Sheet 2 of 2)**

**C – Typical dotted line markings to extend lane line markings into the intersection**



**D – Typical dotted line markings to extend center line and lane line markings into the intersection**





## Section 3B.12 Lane-Reduction Transitions

### Support:

- 01 A lane-reduction is where the number of through lanes is reduced at a location that is not at an interchange or intersection because of narrowing of the roadway or because of a section of on-street parking in what would otherwise be a through lane.
- 02 Section 3B.07 contains information on pavement markings for lane drops and splits.
- 03 Section 2C.47 contains information for warning signing used for lane reductions.

### Standard:

- 04 **Lane-reduction transitions (see Figure 3B-14) shall include the following elements:**
- A. **A no-passing zone (see Section 3B.03) to prohibit passing in the direction of the convergence and through the transition area except where not applicable such as one-way streets, expressways, and freeways; and**
  - B. **An edge line (see Section 3B.09) in the direction of the convergence and through the transition area, except as provided in Paragraph 6 of this Section.**

### Guidance:

- 05 *Except as provided in Paragraph 6 of this Section, the edge line marking should be installed from the location of the Lane Ends warning sign to beyond the beginning of the narrower roadway.*

### Option:

- 06 On roadways with operating speeds less than 25 mph where curbs clearly define the roadway edge in the lane-reduction transition, or where a through lane becomes a parking lane, the edge line may be omitted as determined by engineering judgment.

### Guidance:

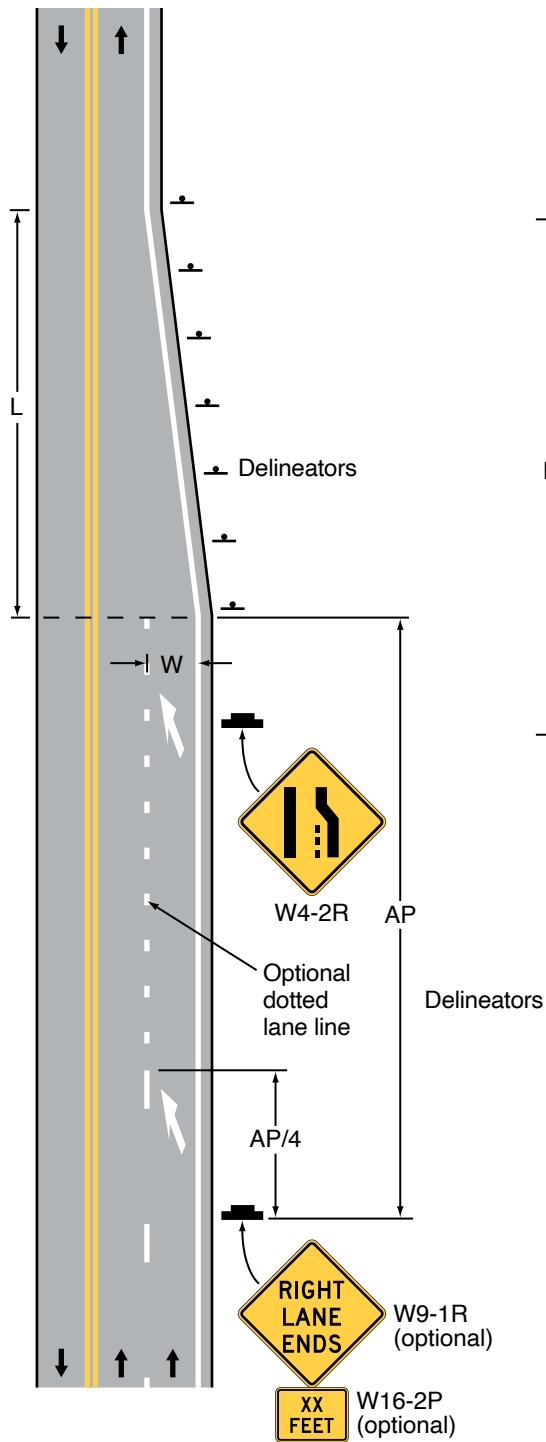
- 07 *Lane-reduction transitions should include the following elements:*
- A. *Delineators installed adjacent to the lane or lanes reduced for the full length of the transition and should be so placed and spaced (see Section 3G.04) to show the reduction except as provided in Paragraph 13 of this Section and except as provided in Paragraph 2 of Section 3G.03 for freeways and expressways,*
  - B. *Lane-reduction arrow markings (see Drawing F in Figure 3B-21) on the roadway with a speed limit of 45 mph or more, and*
  - C. *A termination of the broken white lane line at a point that is ¼ of the advance placement distance (see Section 2C.04) between the Lane Ends sign (see Section 2C.47) and the point where the transition taper begins.*
- 08 *For roadways having a speed limit of 45 mph or greater, the transition taper length for a lane-reduction transition should be computed by the formula  $L = WS$ , where  $L$  equals the taper length in feet,  $W$  equals the width of the offset distance in feet, and  $S$  equals the 85th-percentile speed or the speed limit in mph, whichever is higher. For roadways where the speed limit is less than 45 mph, the formula  $L = WS^2/60$  should be used to compute the taper length.*
- 09 *The minimum lane reduction transition taper length should be 100 feet in urban areas and 200 feet in rural areas.*
- 10 *Where observed speeds exceed speed limits, longer tapers should be used.*

### Option:

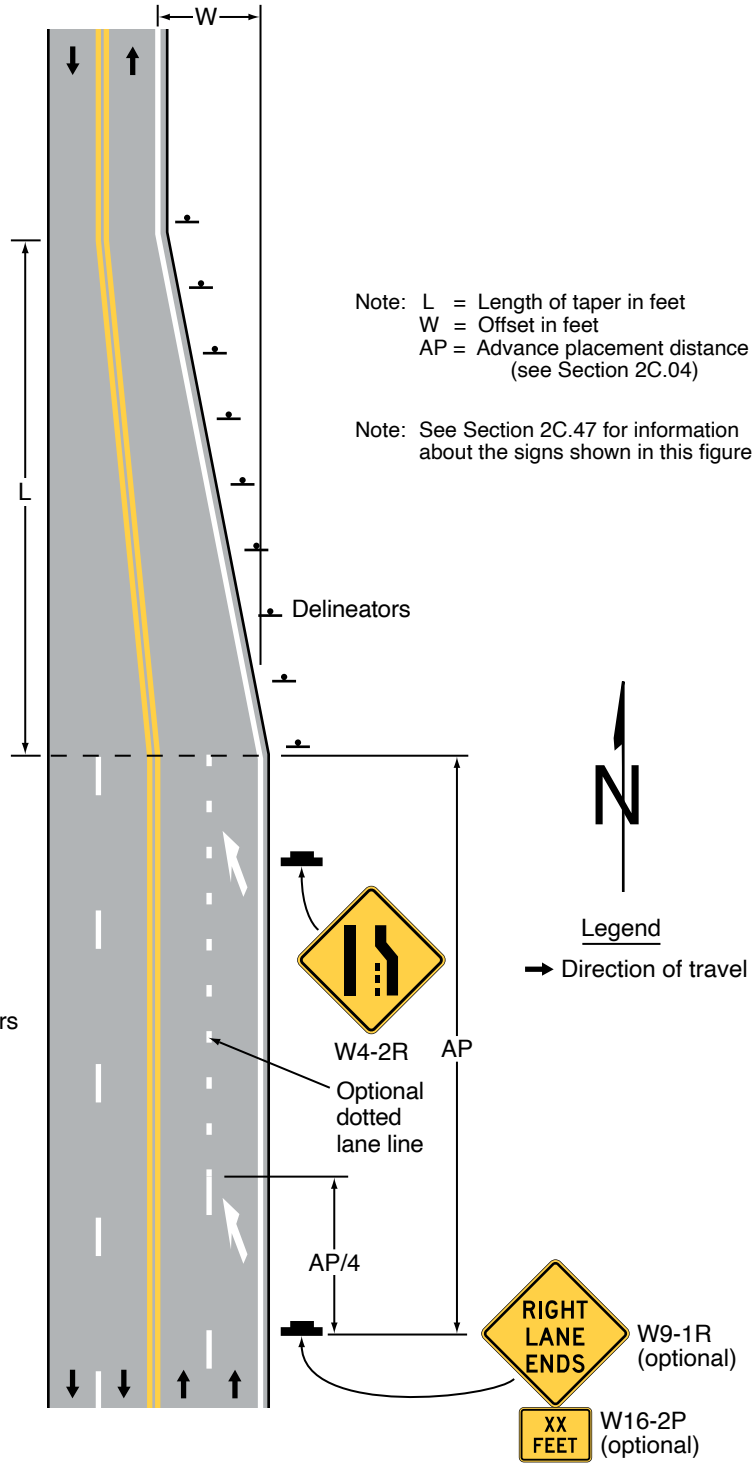
- 11 The minimum taper length may be less than 100 feet on roadways where the operating speed is less than 25 mph.
- 12 On new construction, where no speed limit has been established, the design speed may be used in the transition taper length formula.
- 13 On low-speed urban roadways where curbs clearly define the roadway edge in the lane-reduction transition, or where a through lane becomes a parking lane, delineators may be omitted as determined by engineering judgment.
- 14 Where a lane-reduction transition occurs on a roadway with a speed limit of less than 45 mph, lane-reduction arrow markings may be used.
- 15 Lane-reduction arrow markings may be used in long acceleration lanes based on engineering judgment.
- 16 A dotted white line may be used between the point where the broken white lane line is terminated to the point where the transition taper begins.

**Figure 3B-14. Examples of Applications of Lane-Reduction Transition Markings**

**A – Lane reduction**



**B – Lane reduction with lateral shift to the left**



Note:  $L$  = Length of taper in feet  
 $W$  = Offset in feet  
 $AP$  = Advance placement distance (see Section 2C.04)

Note: See Section 2C.47 for information about the signs shown in this figure



Legend

→ Direction of travel

### Section 3B.13 Approach Markings for Obstructions

#### Standard:

- 01 **Pavement markings shall be used to guide traffic away from fixed obstructions within a paved roadway. Approach markings for bridge supports, refuge islands, median islands, toll plaza islands, and raised channelization islands shall consist of a tapered line or lines extending from the center line or the lane line to a point 1 to 2 feet to the right-hand side, or to both sides, of the approach end of the obstruction (see Figure 3B-15).**

#### Guidance:

- 02 *For roadways having a speed limit of 45 mph or greater, the taper length of the tapered line markings should be computed by the formula  $L = WS$ , where  $L$  equals the taper length in feet,  $W$  equals the width of the offset distance in feet, and  $S$  equals the 85th-percentile speed or the speed limit, whichever is higher. For roadways where the speed limit is less than 45 mph, the formula  $L = WS^2/60$  should be used to compute the taper length.*
- 03 *The minimum taper length should be 100 feet in urban areas and 200 feet in rural areas.*

#### Option:

- 04 The minimum taper length may be less than 100 feet on roadways where the operating speed is less than 25 mph.

#### Standard:

- 05 **If traffic is required to pass only to the right of the obstruction, the markings shall consist of a two-direction no-passing zone marking at least twice the length of the diagonal portion as determined by the appropriate taper formula (see Drawing A in Figure 3B-15).**

#### Option:

- 06 If traffic is required to pass only to the right of the obstruction, yellow diagonal markings (see Section 3B.25) may be placed in the flush median islands (see Section 3J.03) between the no-passing zone markings as shown in Drawings A and B in Figure 3B-15.

#### Standard:

- 07 **If traffic can pass either to the right or left of the obstruction, the markings shall consist of two channelizing lines diverging from the lane line, one to each side of the obstruction. In advance of the point of divergence, a wide solid white line or normal width double solid white line shall be extended in place of the broken lane line for a distance equal to the length of the diverging lines (see Drawing C in Figure 3B-15).**

#### Option:

- 08 If traffic can pass either to the right or left of the obstruction, additional white chevron markings (see Section 3B.25) may be placed in the flush neutral area between the channelizing lines as shown in Drawing C in Figure 3B-15. Other markings, such as white delineators, white channelizing devices, white raised pavement markers, and white crosswalk markings may also be placed in the flush neutral area.

### Section 3B.14 Raised Pavement Markers – General

#### Standard:

- 01 **The color of raised pavement markers under both daylight and nighttime conditions shall conform to the color of the marking for which they serve as a positioning guide, or for which they supplement or substitute.**

#### Option:

- 02 The side of a raised pavement marker that is visible to traffic proceeding in the wrong direction may be red (see Section 3A.03).
- 03 Retroreflective or internally illuminated raised pavement markers may be used in the roadway immediately adjacent to curbed approach ends of raised medians and curbs of islands, or on top of such curbs (see Section 3J.06).

#### Standard:

- 04 **When used, internally illuminated raised pavement markers shall be steadily illuminated and shall not be flashed.**

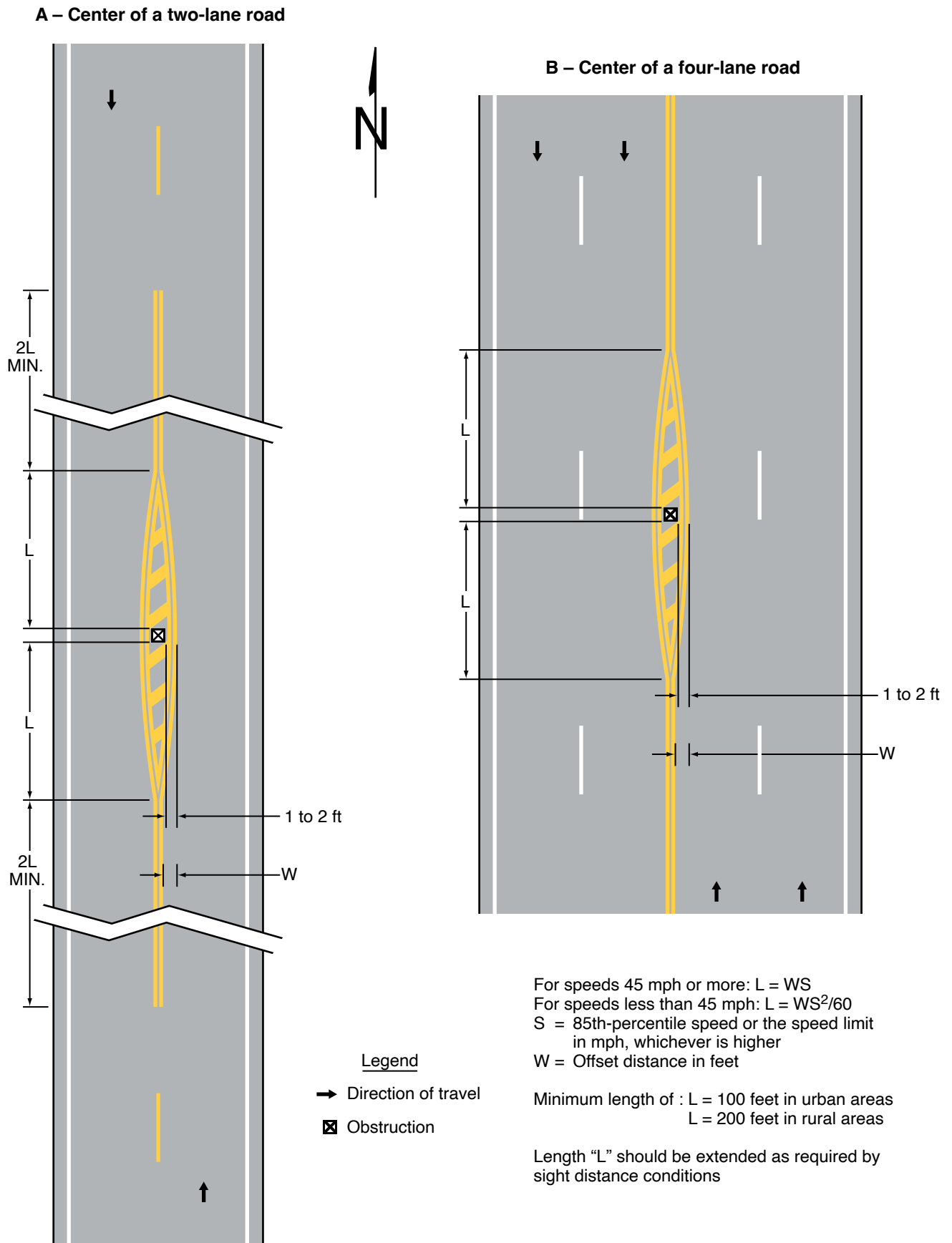
#### Support:

- 05 Flashing raised pavement markers are considered to be In-Roadway Lights (see Chapter 4U).

#### Guidance:

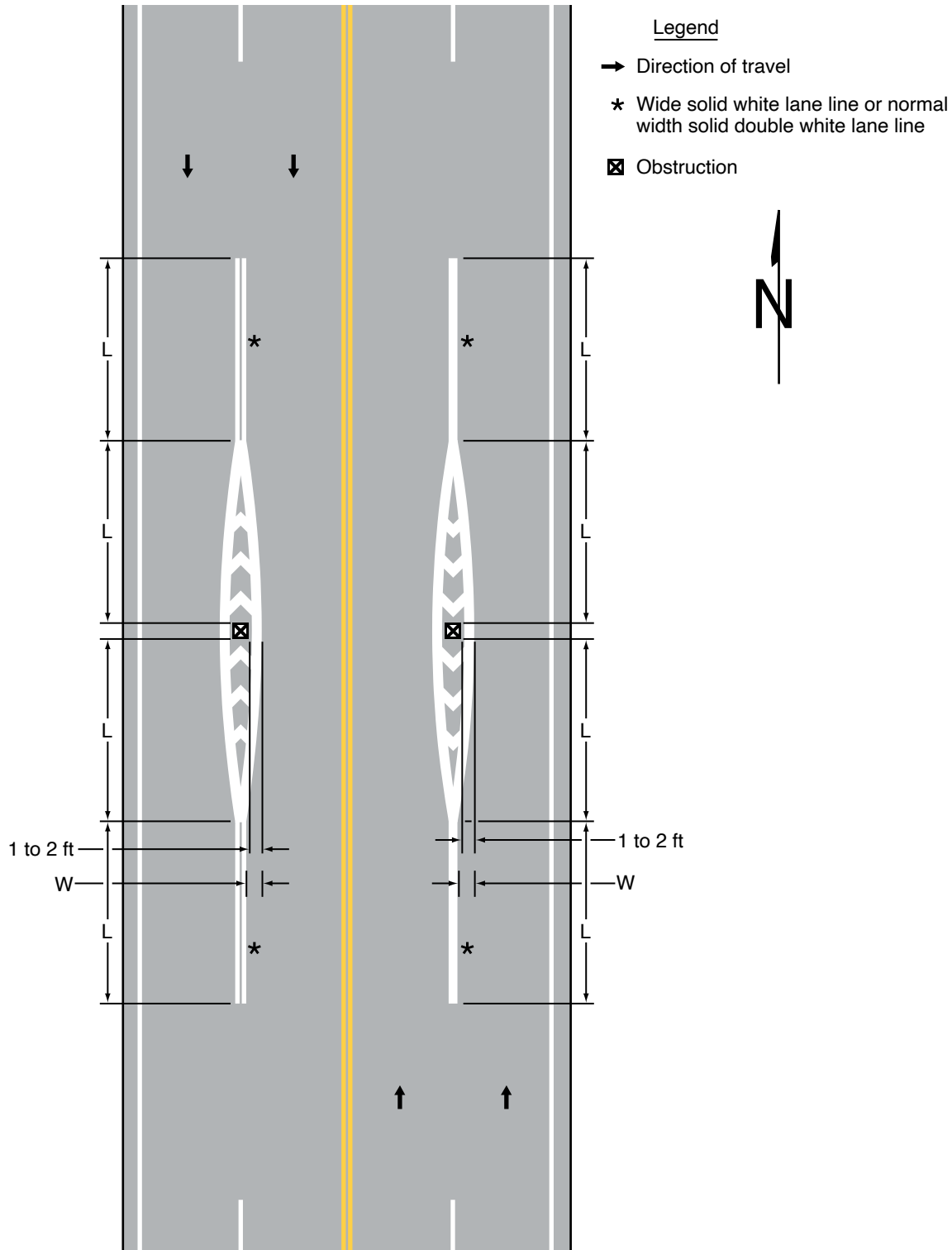
- 06 *The spacing of raised pavement markers used to supplement or substitute for other types of longitudinal markings should correspond with the pattern of broken lines for which the markers supplement or substitute.*

**Figure 3B-15. Examples of Applications of Markings for Obstructions in the Roadway**  
(Sheet 1 of 2)



**Figure 3B-15. Examples of Applications of Markings for Obstructions in the Roadway**  
(Sheet 2 of 2)

**C – Traffic passing in the same direction on both sides of an obstruction**



For speeds of 45 mph or more:  $L = WS$   
 For speeds of less than 45 mph:  $L = WS^2/60$   
 $S$  = 85th-percentile speed or the speed limit  
 in mph, whichever is higher  
 $W$  = Offset distance in feet

Minimum length of:  $L = 100$  feet in urban areas  
 $L = 200$  feet in rural areas

Length "L" should be extended as required by  
 sight distance conditions

**Standard:**

- 07 **The value of N cited in Sections 3B.15 through 3B.17 for the spacing of raised pavement markers shall equal the length of one line segment plus one gap of the broken lines used on the highway.**

## Option:

- 08 For additional emphasis, retroreflective raised pavement markers may be spaced closer than described in Sections 3B.15 through 3B.17, as determined by engineering judgment or engineering study.

## Support:

- 09 Section 9A.03 contains information for the application of raised pavement markers to bicycle facilities.

### **Section 3B.15 Raised Pavement Markers as Vehicle Positioning Guides with Other Longitudinal Markings**

## Option:

- 01 Retroreflective or internally illuminated raised pavement markers may be used as positioning guides with longitudinal line markings without necessarily conveying information to the road user about passing or lane-use restrictions. In such applications, markers may be positioned in line with or immediately adjacent to a single line marking, or positioned between the two lines of a double center line or double lane line marking.

## Guidance:

- 02 *Except as otherwise provided in Paragraphs 3 and 4 of this Section, the spacing for such applications should be 2N (see Section 3B.14).*

## Option:

- 03 Where it is desired to alert the road user to changes in the travel path, such as on sharp curves or on transitions that reduce the number of lanes or that shift traffic laterally, the spacing may be reduced to N or less.
- 04 On freeways and expressways, the spacing may be increased to 3N for relatively straight and level roadway segments where engineering judgment indicates that such spacing will provide adequate delineation under wet night conditions.

### **Section 3B.16 Raised Pavement Markers Supplementing Other Markings**

## Guidance:

- 01 *The use of retroreflective or internally illuminated raised pavement markers for supplementing longitudinal line markings should comply with the following:*
- A. *Lateral Positioning*
    1. *When supplementing double line markings, pairs of raised pavement markers placed laterally in line with or immediately outside of the two lines should be used.*
    2. *When supplementing wide line markings, pairs of raised pavement markers placed laterally adjacent to each other should be used.*
  - B. *Longitudinal Spacing*
    1. *When supplementing solid line markings, raised pavement markers at a spacing no greater than N (see Section 3B.14) should be used, except that when supplementing channelizing lines or edge line markings, a spacing of no greater than N/2 should be used.*
    2. *When supplementing broken line markings, a spacing no greater than 3N should be used. However, when supplementing broken line markings identifying reversible lanes, a spacing of no greater than N should be used.*
    3. *When supplementing dotted lane line markings, a spacing appropriate for the application should be used.*
    4. *When supplementing longitudinal line extension markings through at-grade intersections, one raised pavement marker for each short line segment should be used.*
    5. *When supplementing line extensions through freeway interchanges, a spacing of no greater than N should be used.*
- 02 *Raised pavement markers should not supplement right-hand edge lines unless an engineering study or engineering judgment indicates the benefits of enhanced delineation of a curve or other location would outweigh possible impacts on bicyclists using the shoulder, and the spacing of raised pavement markers on the right-hand edge does not simulate a broken line during wet night conditions.*

## Option:

- 03 Raised pavement markers also may be used to supplement other markings such as channelizing islands, gore areas, approaches to obstructions, or wrong-way arrows.
- 04 To improve the visibility of horizontal curves, center lines may be supplemented with retroreflective or internally illuminated raised pavement markers for the entire curved section as well as for a distance in advance of the curve that approximates 5 seconds of travel time.

### Section 3B.17 Raised Pavement Markers Substituting for Pavement Markings

Option:

- 01 Retroreflective or internally illuminated raised pavement markers, or non-retroreflective raised pavement markers supplemented by retroreflective or internally illuminated markers, may be substituted for markings of other types.

Guidance:

- 02 *If used, the pattern of the raised pavement markers should simulate the pattern of the markings for which they substitute.*

**Standard:**

- 03 **Non-retroreflective raised pavement markers shall not be used alone, without supplemental retroreflective or internally illuminated markers, as a substitute for other types of pavement markings.**

Support:

- 04 Section 6J.02 contains information for flexible temporary pavement markers used during surface treatment paving operations.

**Standard:**

- 05 **If raised pavement markers are used to substitute for broken line markings, a group of three to five markers equally spaced at a distance no greater than N/8 (see Section 3B.14) shall be used. If N is other than 40 feet, the markers shall be equally spaced over the line segment length (at ½ points for three markers, at ⅓ points for four markers, and at ¼ points for five markers). At least one retroreflective or internally illuminated marker per group shall be used or a retroreflective or internally illuminated marker shall be installed midway in each gap between successive groups of non-retroreflective markers.**

- 06 **When raised pavement markers substitute for solid line markings, the markers shall be equally spaced at no greater than N/4, with retroreflective or internally illuminated units at a spacing no greater than N/2.**

Guidance:

- 07 *Raised pavement markers should not substitute for right-hand edge line markings unless an engineering study or engineering judgment indicates the benefits of enhanced delineation of a curve or other location would outweigh possible impacts on bicyclists using the shoulder, and the spacing of raised pavement markers on the right-hand edge line does not simulate a broken line during wet night conditions.*

**Standard:**

- 08 **When raised pavement markers substitute for dotted lines, they shall be spaced at no greater than N/4, with not less than one raised pavement marker per dotted line segment. At least one raised marker every N shall be retroreflective or internally illuminated.**

Option:

- 09 When substituting for wide lines, raised pavement markers may be placed laterally adjacent to each other to simulate the width of the line.

Support:

- 10 Section 5B.02 contains information on raised pavement marker considerations for driving automation systems.

### Section 3B.18 Curb Markings for Parking Regulations

Guidance:

- 01 *Except as provided in Paragraph 4 of this Section, since yellow and white curb markings are frequently used for curb delineation and visibility, parking regulations should be established through the installation of standard signs (see Sections 2B.53 and 2B.54).*

- 02 *Where curbs are marked to convey parking regulations in areas where curb markings are frequently obscured by snow and ice accumulation, signs should be used with the curb markings except as provided in Paragraph 4 of this Section.*

- 03 *Except as provided in Paragraph 4 of this Section, when curb markings are used without signs to convey parking regulations, a legible word marking regarding the regulation (such as “No Parking” or “No Standing”) should be placed on the curb.*

Option:

- 04 Curb markings without word markings or signs may be used to convey a general prohibition by statute of parking within a specified distance of a STOP sign, YIELD sign, driveway, fire hydrant, or crosswalk.

- 05 Local highway agencies may prescribe special colors for curb markings to supplement standard signs for parking regulation.



### Section 3B.19 Stop and Yield Lines

#### Option:

- 01 Stop lines may be used to indicate the point behind which vehicles are required to stop in compliance with a STOP (R1-1) sign, a Stop Here for Pedestrians (R1-5b) sign, a Stop Here for School Crossing (R1-5c) sign, a Stop Here for Trail Crossing (R-5e) sign, or some other traffic control device that requires vehicles to stop, except YIELD signs that are not associated with passive grade crossings.

#### Standard:

- 02 **Stop lines shall consist of solid white lines extending across approach lanes to indicate the point at which the stop is intended or required to be made.**
- 03 **Except as provided in Section 8C.03, stop lines shall not be used at locations where drivers are required to yield in compliance with a YIELD (R1-2) sign, a Yield Here to Pedestrians (R1-5) sign, a Yield Here to School Crossings (R1-5a) sign, a Yield Here to Trail Crossings (R1-5d) sign, or at locations on uncontrolled approaches where drivers or bicyclists are required by State law to yield to pedestrians.**

#### Guidance:

- 04 *Stop lines should be used to indicate the point behind which vehicles are required to stop in compliance with a traffic control signal (see Section 4D.08).*
- 05 *Stop lines should be 12 to 24 inches wide.*

#### Option:

- 06 Stop lines may be omitted at ramp control signals.

#### Support:

- 07 Section 4J.02 contains information regarding the use and application of stop lines in conjunction with a pedestrian hybrid beacon.

#### Standard:

- 08 **If used, a yield line pavement marking shall not be installed without a Yield (R1-2) sign, a Yield Here to Pedestrians (R1-5) sign, a Yield Here to School Crossings (R1-5a) sign, a Yield Here to Trail Crossings (R1-5d) sign, or some other traffic control device that requires vehicles to yield (see Figure 3B-16).**
- 09 **Yield lines shall not be used at locations where drivers are required to stop in compliance with a STOP (R1-1) sign, a Stop Here for Pedestrians (R1-5b) sign, a Stop Here for School Crossing (R1-5c) sign, a Stop Here for Trail Crossing (R1-5e) sign, a traffic control signal, or some other traffic control device.**
- 10 **Yield lines shall consist of a row of solid white isosceles triangles pointing toward approaching vehicles extending across approach lanes to indicate the point at which the yield is intended or required to be made.**

#### Option:

- 11 If a yield line marking is used on a bicycle facility, a Bicycles Yield to Pedestrians (R9-6) sign (see Section 9B-12) may be used.

#### Guidance:

- 12 *The individual triangles comprising the yield line should have a base of 12 to 24 inches wide and a height equal to 1.5 times the base. The space between the triangles should be 3 to 12 inches.*
- 13 *If used, stop and yield lines should be placed a minimum of 4 feet in advance of the nearest crosswalk line at controlled intersections, except for yield lines at roundabouts as provided for in Section 3D.04 and at midblock crosswalks. In the absence of a marked crosswalk, the stop line or yield line should be placed at the desired stopping or yielding point, but should not be placed more than 30 feet or less than 4 feet from the nearest edge of the intersecting traveled way.*

#### Standard:

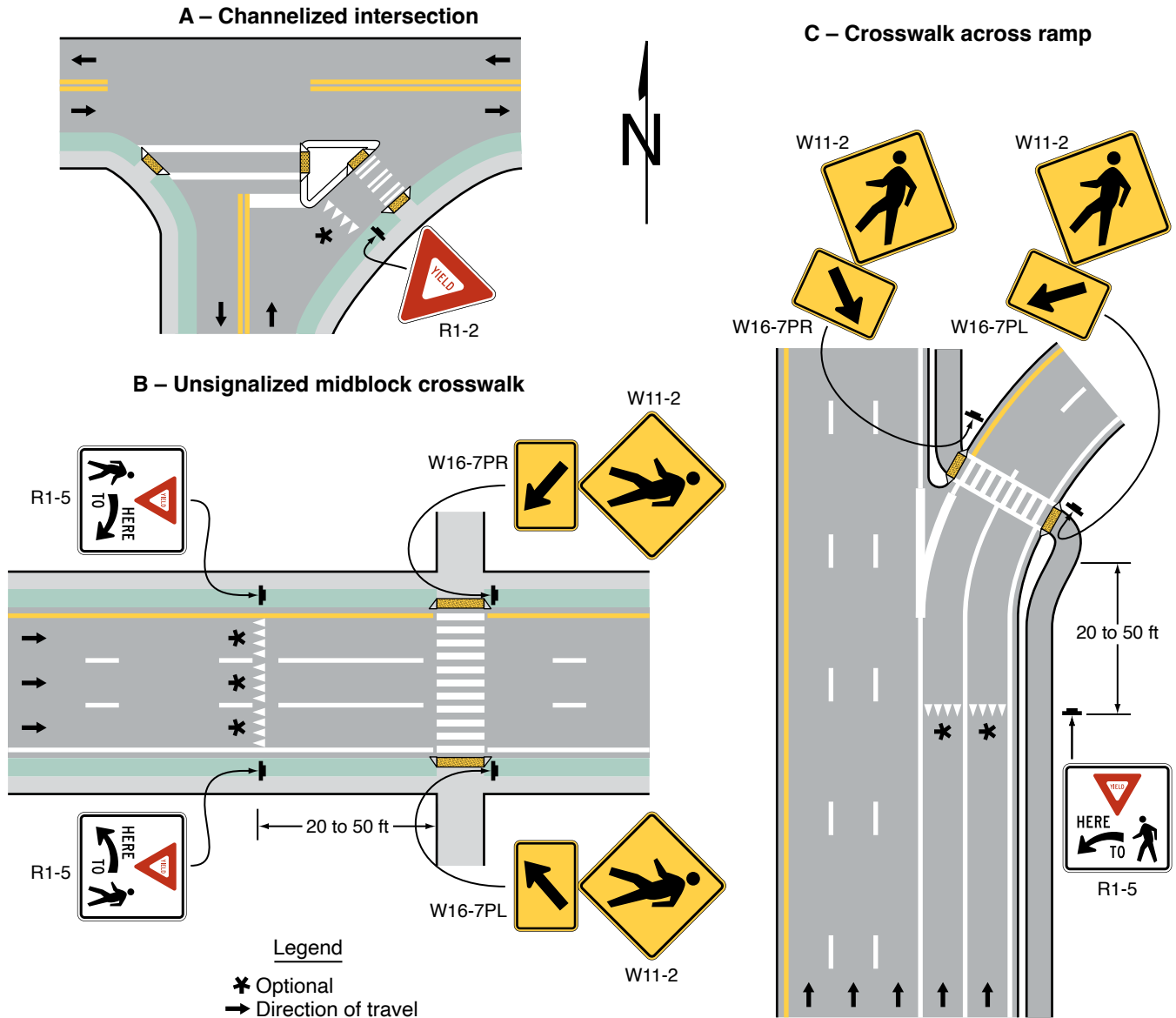
- 14 **If yield (stop) lines are used at a crosswalk that crosses an uncontrolled multi-lane approach, Yield Here to (Stop Here for) Pedestrians (R1-5 series) signs (see Section 2B.19) shall be used.**

#### Guidance:

- 15 *If yield (stop) lines are used at a crosswalk that crosses an uncontrolled multi-lane approach, the yield (stop) line should be placed 20 to 50 feet in advance of the nearest crosswalk line (see Drawing B in Figure 3B-16).*
- 16 *If yield or stop lines are used in advance of a crosswalk that crosses an uncontrolled multi-lane approach, parking should be prohibited in the area between the yield or stop line and the crosswalk.*



**Figure 3B-16. Examples of Yield Line Applications**



Support:

- 17 Section 9B.12 contains information for providing signing applicable to bicyclists also subject to a yielding requirement at a crosswalk that crosses an uncontrolled approach.

Guidance:

- 18 *Yield (stop) lines and Yield Here to (Stop Here for) Pedestrians signs should not be used in advance of crosswalks that cross an approach to or departure from a circular intersection.*

Support:

- 19 Section 8C.03 contains information regarding the use of stop lines and yield lines at grade crossings.

Option:

- 20 Stop and yield lines may be staggered longitudinally on a lane-by-lane basis (see Drawing D in Figure 3B-13).

Support:

- 21 Staggered stop lines and staggered yield lines can improve the driver’s view of pedestrians, provide better sight distance for turning vehicles, and increase the turning radius for left-turning vehicles.

### **Section 3B.20 Word, Symbol, and Arrow Pavement Markings – General**

#### Support:

- 01 Word, symbol, and arrow markings on the pavement are used for the purpose of regulating, warning, or guiding traffic. These pavement markings can be helpful to road users in some locations by supplementing signs and providing additional emphasis for important regulatory, warning, or guidance messages, because the markings do not require diversion of the road user's attention from the roadway surface. Symbol messages are preferable to word messages. Examples of standard word and arrow pavement markings are shown in Figures 3B-17 and 3B-21, respectively.

#### Option:

- 02 Word, symbol, and arrow pavement markings may be used as determined by engineering judgment to supplement signs and/or to provide additional emphasis for regulatory, warning, or guidance messages provided by other devices.

#### Support:

- 03 Section 8C.04 contains information for arrow pavement markings in the vicinity of grade crossings.

#### **Standard:**

- 04 **Word, symbol, and arrow markings shall be white, except as otherwise provided in this Section.**  
 05 **Pavement marking letters, numerals, symbols, and arrows shall be installed in accordance with the design details in the Pavement Markings chapter of the “Standard Highway Signs” publication (see Section 1A.05).**

#### *Guidance:*

- 06 *Word, symbol, and/or arrow markings that are grouped together to formulate one interrelated message should not exceed three lines of information.*  
 07 *Except for the two opposing white arrows of a two-way left-turn lane marking (see Figure 3B-7) and the pavement word marking messages described in Items B and D of Paragraph 2 of Section 3B.26, the longitudinal space between word, symbol, and/or arrow markings that are used together to formulate one interrelated message should be at least four times the height of the characters for low-speed roads, but not more than ten times the height of the characters under any conditions.*  
 08 *Except for the SCHOOL word marking (see Section 7C.02), pavement word, symbol, and arrow markings should be no more than one lane in width.*  
 09 *Pavement word, symbol, and arrow markings should be proportionally scaled to fit within the width of the facility upon which they are applied.*

#### Option:

- 10 On narrow, low-speed shared-use paths, the pavement words, symbols, and arrows may be smaller than suggested, but to the relative scale.  
 11 On roadways where the operating speed is less than 25 mph, word, symbol, and arrow markings may be proportionally reduced by 25 percent.

### **Section 3B.21 Word Pavement Markings**

#### *Guidance:*

- 01 *Letters and numerals should be 6 feet or more in height, except as provided in Section 9E.01 for the BIKE LANE word pavement marking and in Section 9E.15 for a bicycle detector symbol and WAIT HERE FOR GREEN word pavement marking.*  
 02 *If a pavement marking word message consists of more than one line of information, it should read in the direction of travel. The first word of the message should be nearest to the road user.*

#### **Standard:**

- 03 **The word STOP shall not be placed on the pavement in advance of a stop line, unless every vehicle is required to stop at all times.**

*Guidance:*

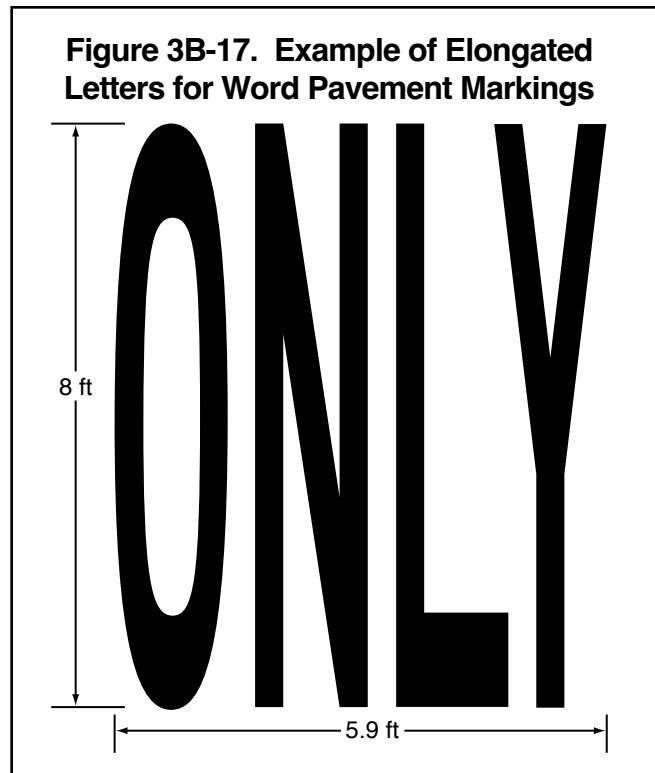
- 04 Where through lanes approaching an intersection become mandatory turn lanes, **ONLY** word pavement markings (see Figure 3B-17) should be used in addition to signs (see Sections 2B.27 and 2B.28) and the required lane-use arrow markings (see Section 3B.23).

*Option:*

- 05 The **ONLY** word marking may be used to supplement the lane-use arrow markings in lanes that are designated for the exclusive use of a single movement such as turn bays.
- 06 The **ONLY** word marking may be used to supplement a preferential lane word or symbol marking (see Section 3E.03).
- 07 On roadways where the operating speed is less than 25 mph, word markings may be proportionally reduced by 25 percent.

**Standard:**

- 08 **The **ONLY** word marking shall not be used in a lane that is shared by more than one movement.**



**Section 3B.22 Symbol Pavement Markings**

*Support:*

- 01 Section 3E.03 contains information on the diamond-shaped symbol for high-occupancy vehicle (HOV) lanes.
- 02 Chapter 9E contains information on symbol markings that can be used for bicycle lanes.

*Option:*

- 03 Pavement markings simulating Interstate, U.S., State, and County route signs (see Figure 2D-4) with appropriate route numbers, but elongated for proper proportioning when viewed as a marking, may be used to guide road users to their destinations (see Figure 3B-18).

*Guidance:*

- 04 If route sign markings are provided to guide road users, those route sign markings should be provided in option lanes if markings are provided in any lanes.
- 05 If two route sign markings are provided in an option lane, they should be placed in sequence and not divided around an optional lane arrow.

**Figure 3B-18. Examples of Elongated Route Shields and Markers Applied as Pavement Markings**

**A – Interstate Shield on dark or light pavement**



**B – U.S. Route Shield on dark pavement**



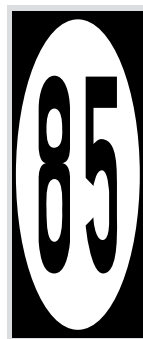
**C – U.S. Route Shield on light pavement**



**D – State Route Marker on dark pavement**



**E – State Route Marker on light pavement**



Note: See the “Standard Highway Signs” publication for sizes and details

Support:

06 Section 3A.03 provides information on route sign colors.

07 Section 9E.14 contains information on route markers for designated bicycle routes that can be used on shared-use paths.

Guidance:

08 *The International Symbol of Accessibility parking space marking (see Figure 3B-19) should be placed in each parking space designated for use by persons with disabilities.*

Option:

09 A blue background with white border may supplement the wheelchair symbol as shown in Figure 3B-19.

10 A yield-ahead triangle symbol or YIELD AHEAD word pavement marking may be used on approaches to intersections where the approaching traffic will encounter a YIELD sign at the intersection.

Standard:

11 **The yield-ahead triangle symbol or YIELD AHEAD word pavement marking shall not be used unless a YIELD sign (see Section 2B.05) is in place at the intersection. The yield-ahead triangle symbol marking shall be as shown in Figure 3B-20.**

Option:

12 A pedestrian symbol pavement marking may be used on portions of facilities that are reserved exclusively for pedestrian use, such as where a shared-use path transitions to become separate facilities for different types of users.

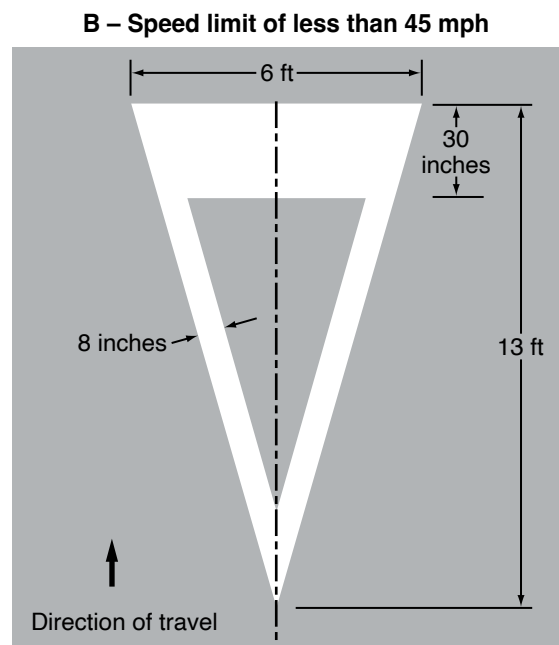
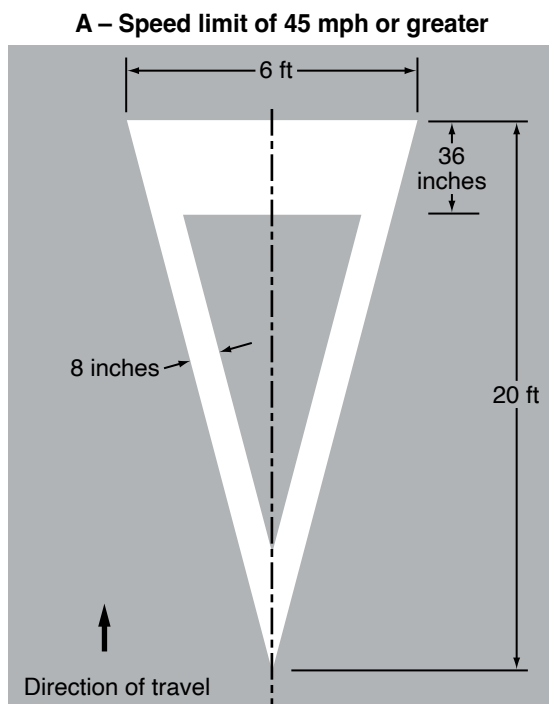
**Figure 3B-19. International Symbol of Accessibility Parking Space Marking**



Notes:

1. See the "Standard Highway Signs" publication for sizes and details
2. The blue-colored background with white border is optional

**Figure 3B-20. Yield Ahead Triangle Symbols**



### Section 3B.23 Lane-Use Arrows

#### Support:

- 01 Lane-use arrow markings (see Figure 3B-21) are used to indicate the mandatory or permissible movements in certain lanes (see Figure 3B-22) and in two-way left-turn lanes (see Figure 3B-7).
- 02 Section 8C.04 contains information about the placement of lane-use arrow markings in the vicinity of grade crossings.

#### Guidance:

- 03 *Lane-use arrow markings should be used in lanes and turn bays designated for the exclusive use of a turning movement, except where engineering judgment determines that physical conditions or other markings (such as a dotted extension of the lane line through the taper into the turn bay) clearly discourage unintentional use of a turn bay by through vehicles. Lane-use arrow markings should also be used in lanes from which movements are allowed that are contrary to the normal rules of the road (see Drawing B in Figure 3B-13).*
- 04 *When used in turn lanes, at least two arrows should be used, one at or near the upstream end of the full-width turn lane and one an appropriate distance upstream from the stop line or intersection (see Drawing A in Figure 3B-12).*
- 05 *Where opposing offset channelized left-turn lanes exist, lane-use arrow markings should be placed near the downstream terminus of the offset left-turn lanes to reduce wrong-way movements (see Figure 2B-20).*

#### Option:

- 06 An additional arrow or arrows may be used in a turn lane. When arrows are used for a short turn lane, the second (downstream) arrow may be omitted based on engineering judgment.

#### Support:

- 07 An arrow at the downstream end of a turn lane can help to prevent wrong-way movements.

#### Standard:

- 08 **Where through lanes approaching an intersection become mandatory turn lanes, turn lane-use arrow markings (see Drawing A in Figure 3B-12 and Figure 3B-21) shall be used and shall be accompanied by standard signs (see Section 2B.28).**

#### Guidance:

- 09 *Where through lanes approaching an intersection become mandatory turn lanes, ONLY word markings (see Figure 3B-17) should be used in addition to signs (see Sections 2B.27 and 2B.28) and the required turn lane-use arrow markings. These signs and markings should be placed well in advance of the turn and should be repeated as necessary to provide the through motorist advance notification to vacate the lane prior to reaching a point where roadway geometrics or a queue of waiting vehicles forces the motorist to make an unintended turn.*

#### Option:

- 10 On freeways or expressways where a through lane becomes a mandatory exit lane, lane-use arrow markings may be used on the approach to the exit in the dropped lane and in an adjacent optional through-or-exit lane if one exists.

### Section 3B.24 Wrong-Way Arrows

#### Guidance:

- 01 *Where crossroad channelization or ramp geometrics do not make wrong-way movements difficult, the appropriate lane-use arrow should be placed in each lane of an exit ramp near the crossroad terminal where it will be clearly visible to a potential wrong-way road user (see Figure 2B-15).*

#### Option:

- 02 The wrong-way arrow markings shown in Drawing G in Figure 3B-21 may be placed near the downstream terminus of a ramp as shown in Figure 2B-15 and in Drawing A in Figure 2B-16, or at other locations where lane-use arrows are not appropriate, to indicate the correct direction of traffic flow and to discourage drivers from traveling in the wrong direction.

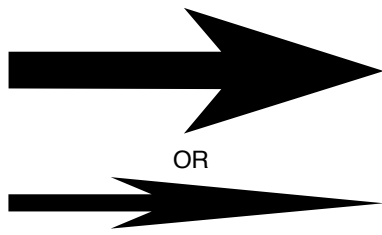
### Section 3B.25 Chevron and Diagonal Markings

#### Support:

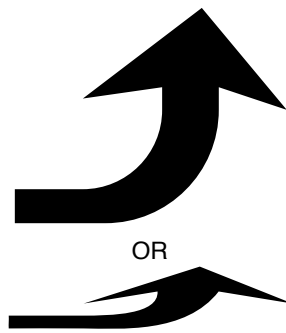
- 01 Chevron or diagonal markings are used to discourage travel on certain paved areas, such as shoulders, neutral areas, and flush median islands.

Figure 3B-21. Examples of Standard Arrows for Pavement Markings

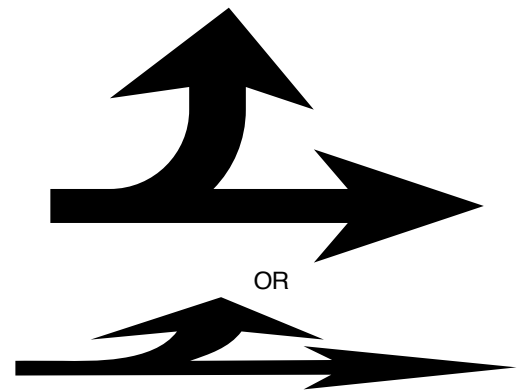
A – Through lane-use arrow



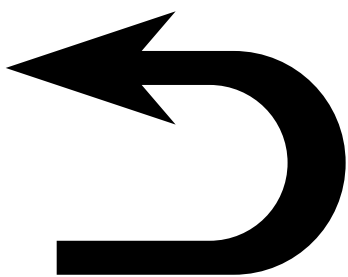
B – Turn lane-use arrow



C – Turn and through lane-use arrow



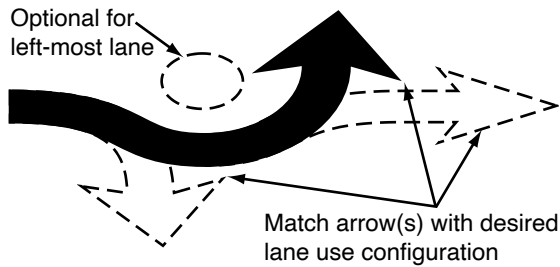
D – U-Turn lane-use arrow



E – U-Turn and through lane-use arrow



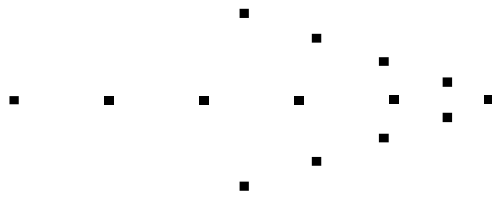
F – Curved-stem lane-use arrows



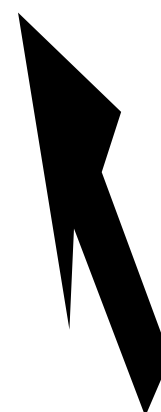
G – Wrong-way arrow



H – Wrong-way arrow using retroreflective raised pavement markers

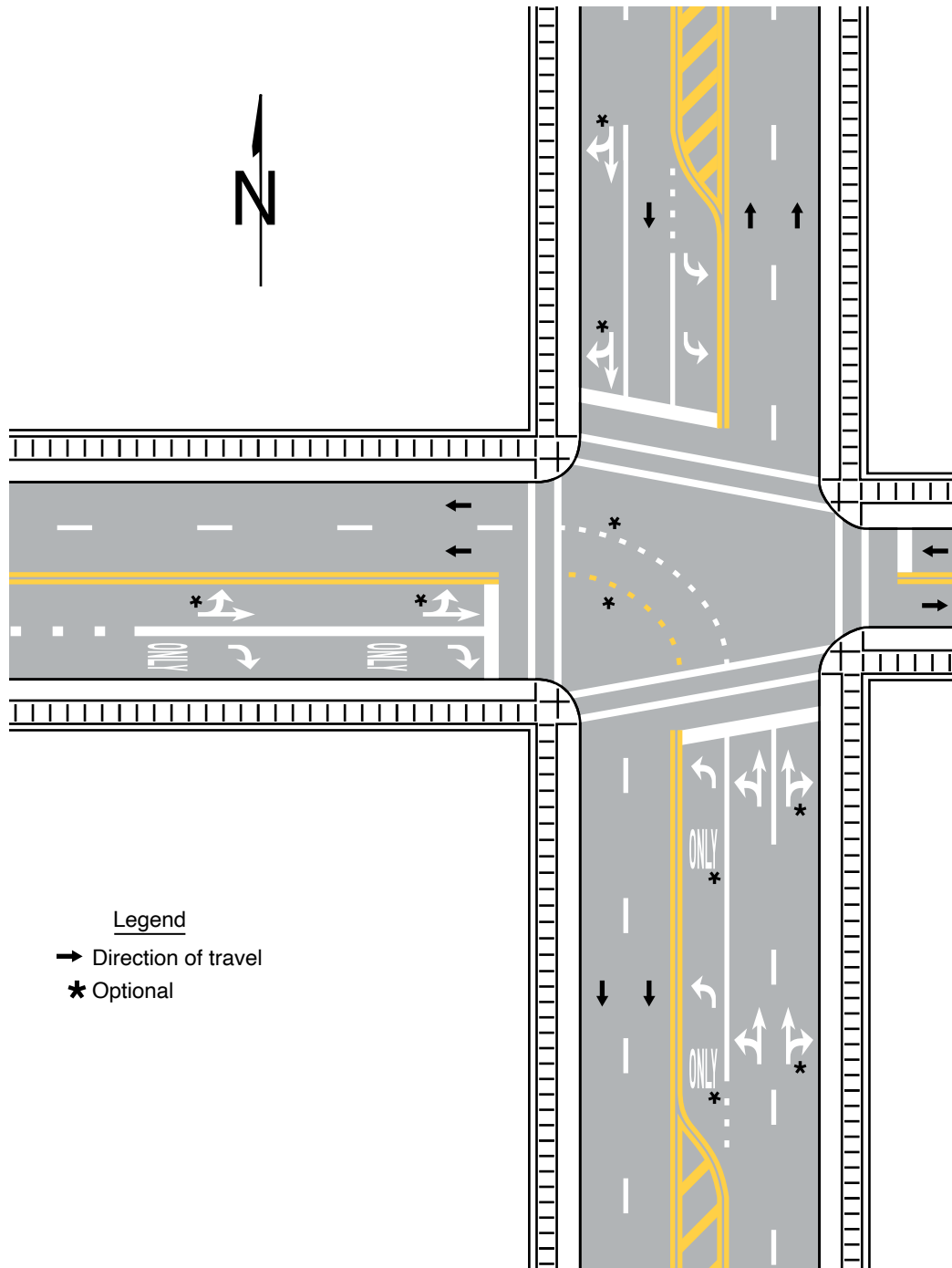


I – Lane-reduction arrow



Notes:

1. See the "Standard Highway Signs" publication for sizes and details
2. Refer to Section 3B.20 for guidance and options for proportionally scaling the arrows

**Figure 3B-22. Examples of Lane-Use Control Word and Arrow Pavement Markings****Option:**

- 02 Chevron and diagonal markings may be used:
- A. On approaches to obstructions in the roadway (see Sheet 2 of Figure 3B-15),
  - B. For channelized travel paths on approaches to intersections,
  - C. In buffer spaces between preferential lanes and general-purpose lanes (see Drawing A in Figure 3E-2),
  - D. In the neutral area gores (see Figures 3B-9 through 3B-11),
  - E. In the neutral area of bifurcations created from open-road tolling lanes that bypass a conventional toll plaza,
  - F. In the neutral areas at access and egress points to and from a managed-lane facility (see Figures 2G-8, 2G-10, 2G-22, and 2G-23), and
  - G. In the neutral areas of islands.

- 03 Chevron markings may be supplemented with white retroreflective or internally illuminated raised pavement markers (see Section 3B.16) for enhanced nighttime visibility.

Support:

- 04 Section 5B.02 contains information on chevron markings for driving automation system considerations.

**Standard:**

- 05 **Chevron markings shall be white, with the point of each chevron facing toward approaching traffic, as shown in Figures 3B-9 through 3B-11, and Drawing C in Figure 3B-15.**

Option:

- 06 Diagonal markings for opposing directions of traffic may be used:
- A. On approaches to obstructions in the roadway (see Drawings A and B in Figure 3B-15),
  - B. In flush median islands between double solid yellow center line markings (see Figure 3B-5), and
  - C. In buffer spaces between preferential lanes and general-purpose lanes (see Drawing D in Figure 3E-4).
- 07 Diagonal markings may be used on paved shoulders or in no-parking zones, or other locations for special emphasis.

**Standard:**

- 08 **When diagonal markings are used between opposing directions of traffic or on the left shoulder of a one-way or divided roadway, they shall be yellow and slant away from traffic in the adjacent travel lanes, as shown in Figures 3B-2 and 3B-5, and Drawings A and B in Figure 3B-15.**
- 09 **When diagonal markings are used on the right shoulder or in no-parking zones (see Figure 3B-23), they shall be white and slant away from traffic in the adjacent travel lane.**

*Guidance:*

- 10 *Except as provided in Paragraph 11 of this Section, chevrons and diagonal markings should be at least 12 inches wide for roadways having a speed limit of 45 mph or greater, and at least 8 inches wide for roadways having a speed limit of less than 45 mph. The longitudinal spacing of the chevrons or diagonal lines should be determined by engineering judgment considering factors such as speeds and desired visual impacts. The chevrons and diagonal lines should form an angle of approximately 30 to 45 degrees with the longitudinal lines that they intersect.*

Option:

- 11 Diagonal markings used in no-parking zones or on roadways with operating speeds of less than 25 mph may be 4 inches wide (see Figure 3B-23).

### **Section 3B.26 Do Not Block Intersection Markings**

Option:

- 01 Do Not Block Intersection markings may be used to mark the edges of an intersection area that is in close proximity to a signalized intersection, railroad crossing, or other nearby traffic control that might cause vehicles to stop within the intersection and impede other traffic entering the intersection. If authorized by law, Do Not Block Intersection markings with appropriate signs may also be used at other locations.

**Standard:**

- 02 **If used, Do Not Block Intersection markings (see Figure 3B-24) shall consist of one of the following alternatives:**
- A. **Wide solid white lines that outline the intersection area that vehicles must not block;**
  - B. **Wide solid white lines that outline the intersection area that vehicles must not block and a white word message such as DO NOT BLOCK or KEEP CLEAR;**
  - C. **Wide solid white lines that outline the intersection area that vehicles must not block and white cross-hatching within the intersection area; or**
  - D. **A white word message, such as DO NOT BLOCK or KEEP CLEAR, within the intersection area that vehicles must not block.**
- 03 **DO NOT BLOCK INTERSECTION markings shall be accompanied by one or more DO NOT BLOCK INTERSECTION (DRIVEWAY) (CROSSING) (R10-7) signs (see Section 2B.59), one or more DO NOT STOP ON TRACKS (R8-8) signs (see Section 8B.07), or one or more similar signs.**

### **Section 3B.27 Parking Space Markings**

**Standard:**

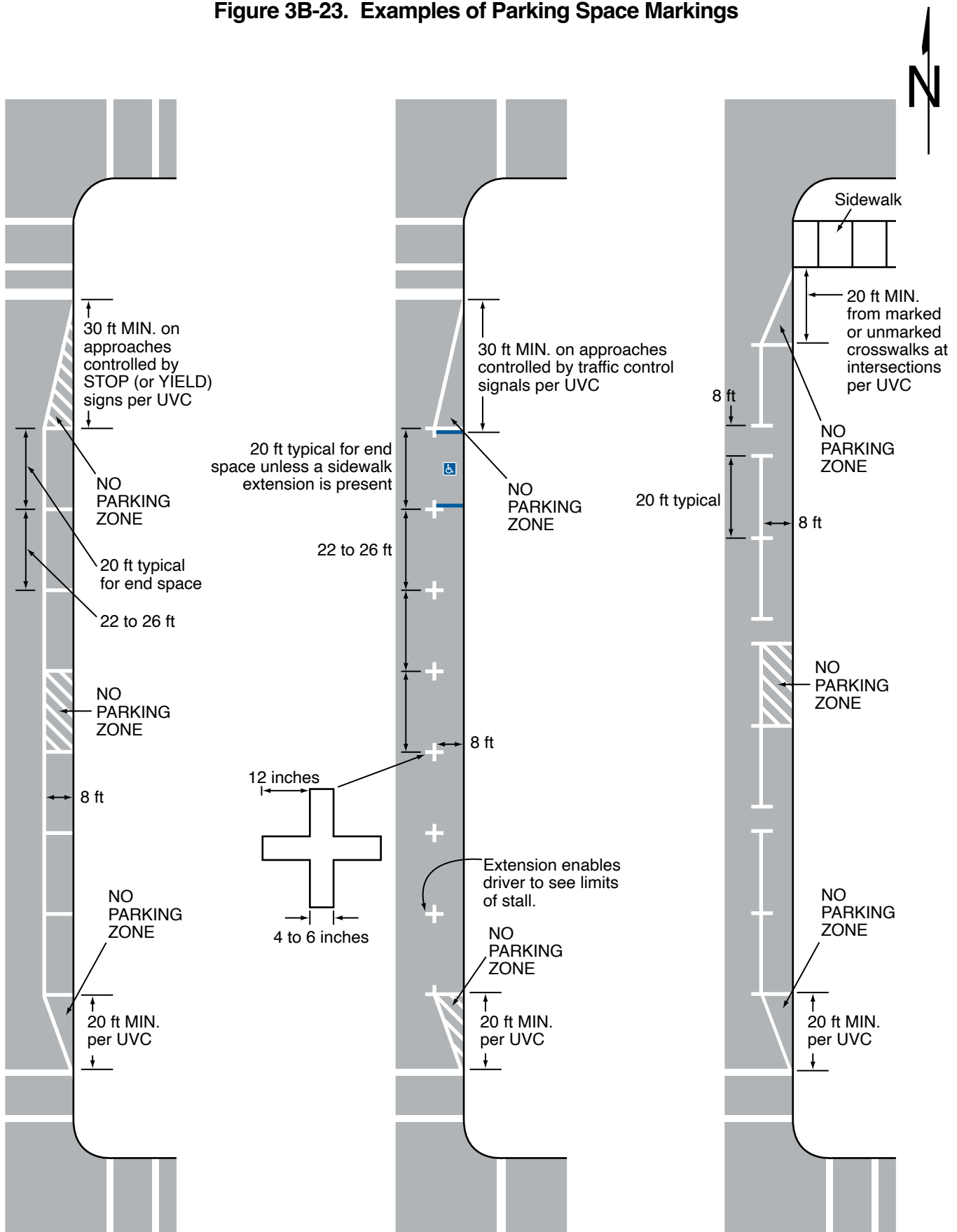
- 01 **On-street parking space markings shall be white.**

Support:

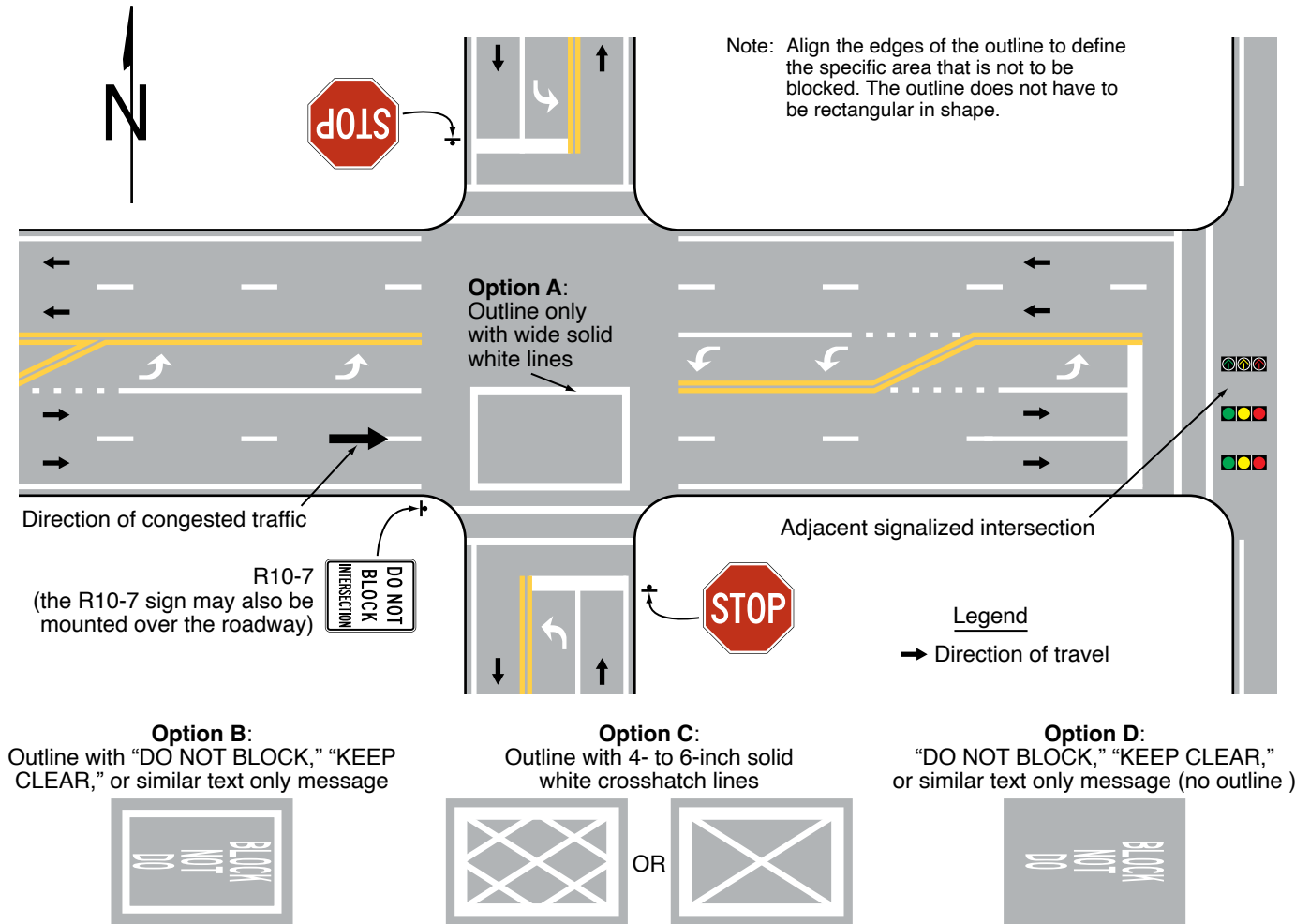
- 02 Examples of on-street parking space markings are shown in Figure 3B-23.



Figure 3B-23. Examples of Parking Space Markings



**Figure 3B-24. Do Not Block Intersection Markings**



Option:

- 03 Blue lines may supplement white parking space markings of each parking space designated for use only by persons with disabilities (see Figure 3B-23).

Support:

- 04 Additional parking space markings for the purpose of designating spaces for use only by persons with disabilities are discussed in Section 3B.22 and illustrated in Figure 3B-19.

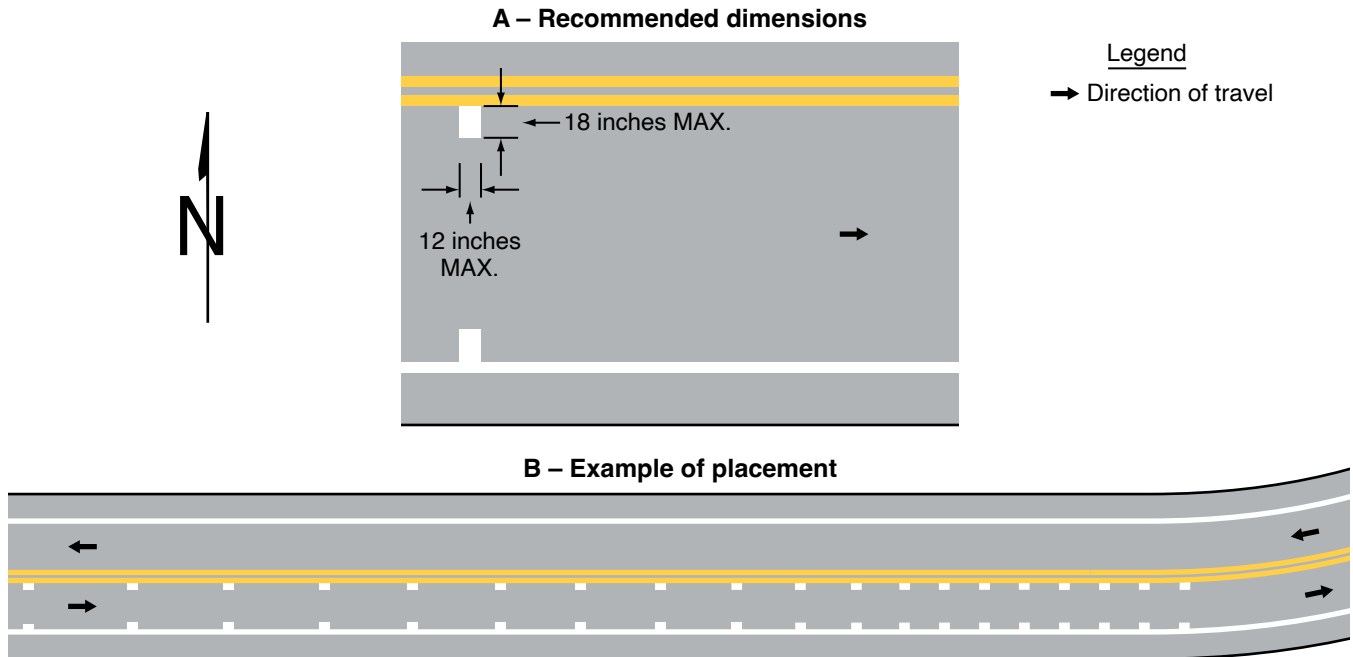
**Section 3B.28 Speed Reduction Markings**

Support:

- 01 Speed reduction markings (see Figure 3B-25) are transverse markings that are placed on the roadway within a lane (along both edges of the lane) in a pattern of progressively reduced spacing to give drivers the impression that their speed is increasing.
- 02 Speed reduction markings have been shown to enhance safety around curves and locations with a history of run-off-the-road crashes when applied in combination with horizontal alignment warning signs (see Section 2C.05).

Option:

- 03 Speed reduction markings may be placed in advance of an unexpectedly severe horizontal or vertical curve or other roadway feature where drivers need to decelerate prior to reaching the feature and where the desired reduction in speeds has not been achieved by the installation of warning signs and/or other traffic control devices.

**Figure 3B-25. Example of the Application of Speed Reduction Markings***Guidance:*

- 04 *If used, speed reduction markings should be reserved for unexpected curves or other usages based on engineering judgment. Speed reduction markings should not be used on long tangent sections of roadway or in areas frequented mainly by local or familiar drivers, such as school zones. If used, speed reduction markings should supplement the appropriate warning signs and other traffic control devices and should not substitute for these devices.*

**Standard:**

- 05 **Speed reduction markings shall be a series of white transverse lines on both sides of the lane that are perpendicular to the center line, edge line, or lane line.**

*Guidance:*

- 06 *The longitudinal spacing between the markings should be progressively reduced from the upstream to the downstream end of the marked portion of the lane.*
- 07 *Speed reduction markings should not be greater than 12 inches in width, and should not extend more than 18 inches into the lane.*

**Standard:**

- 08 **Speed reduction markings shall be used only in lanes that have a longitudinal line (center line, edge line, or lane line) on both sides of the lane.**

**Section 3B.29 Speed Hump and Speed Table Markings****Standard:**

- 01 **If speed hump markings are used, they shall be a series of white markings placed on a speed hump to identify its location. If markings are used for a speed hump that does not also function as a crosswalk or speed table, the markings shall comply with Option A, B, or C shown in Figure 3B-26. If markings are used for a speed hump that also functions as a crosswalk or speed table, the markings shall comply with Option A or B shown in Figure 3B-27.**

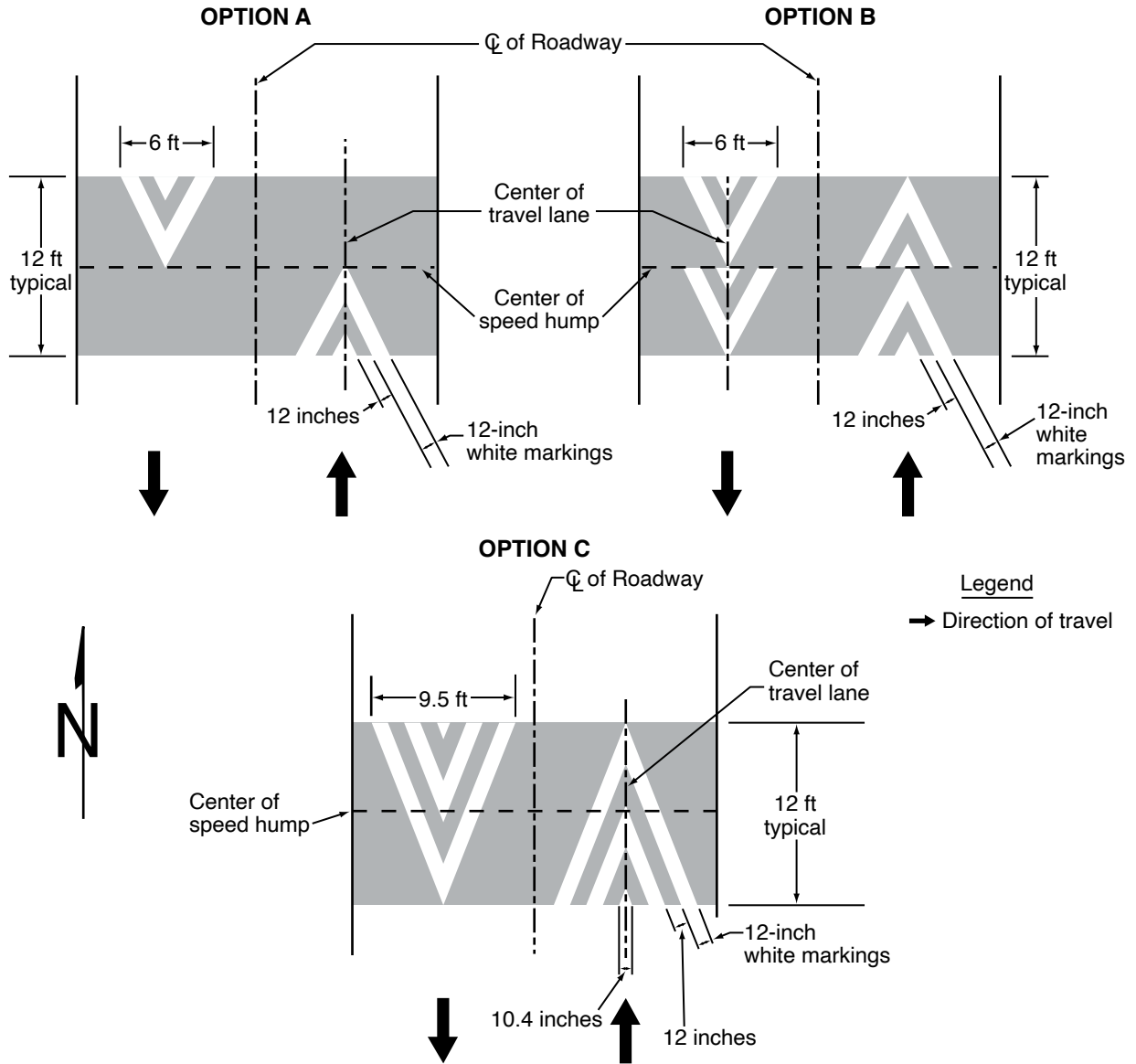
*Option:*

- 02 *Where used, center line markings, lane line markings, and edge lines may be discontinued on the profile of the speed hump.*

**Standard:**

- 03 **Where a speed hump or a speed table specifically incorporates a crossing movement for pedestrians, bicyclists, or equestrians, and functions as a raised crosswalk, crosswalk markings (see Chapter 3C) shall be provided.**

**Figure 3B-26. Pavement Markings for Speed Humps without Crosswalks**



**Section 3B.30 Advance Speed Hump and Speed Table Markings**

Option:

- 01 Advance speed hump markings (see Figure 3B-28) may be used in advance of speed humps or other engineered vertical roadway deflections such as dips where added visibility is desired or where such deflection is not expected.
- 02 Advance word pavement markings such as BUMP or HUMP (see Section 3B.20) may be used on the approach to a speed hump either alone or in conjunction with advance speed hump markings. Appropriate advance warning signs may be used in compliance with Section 2C.27.

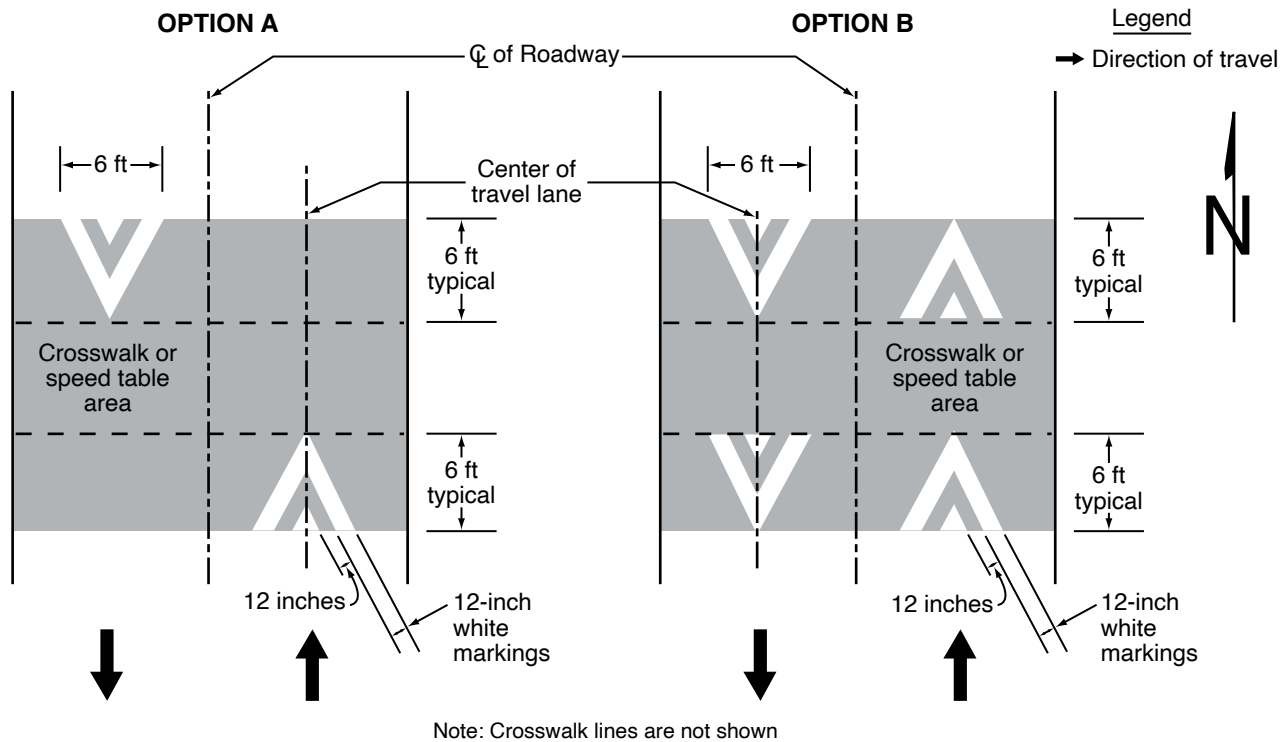
**Standard:**

- 03 **If advance speed hump or speed table markings are used, they shall be a series of eight white 12-inch transverse lines that become longer and are spaced closer together as the vehicle approaches the speed hump or other deflection. If advance markings are used, they shall comply with the detailed design shown in Figure 3B-28.**

*Guidance:*

- 04 *If used, advance speed hump markings should be installed in each approach lane.*

**Figure 3B-27. Pavement Markings for Speed Tables or Speed Humps with Crosswalks**



**Section 3B.31 Markings for a Diamond Interchange with a Transposed Alignment Crossroad**

Support:

01 Markings used in a diverging diamond interchange with a transposed alignment crossroad can be advantageous for minimizing wrong-way movements. The potential for wrong-way movements is greatest at the crossover intersections where the alignment becomes transposed.

**Standard:**

02 **On the transposed alignment, each direction shall be considered a one-way roadway whereas the edge line convention shall be in accordance with Section 3B.09. Both yellow and white lines shall be used.**

03 **A lane-use arrow (see Section 3B.23) shall be used in each approach lane at the crossover intersection.**

Support:

04 Section 3C.11 contains information on crosswalks and pedestrian movements for diverging diamond interchanges with a transposed alignment crossroad.

**Standard:**

05 **Flush median islands (see Section 3J.03) shall not be used to divide the inverted flow of traffic.**

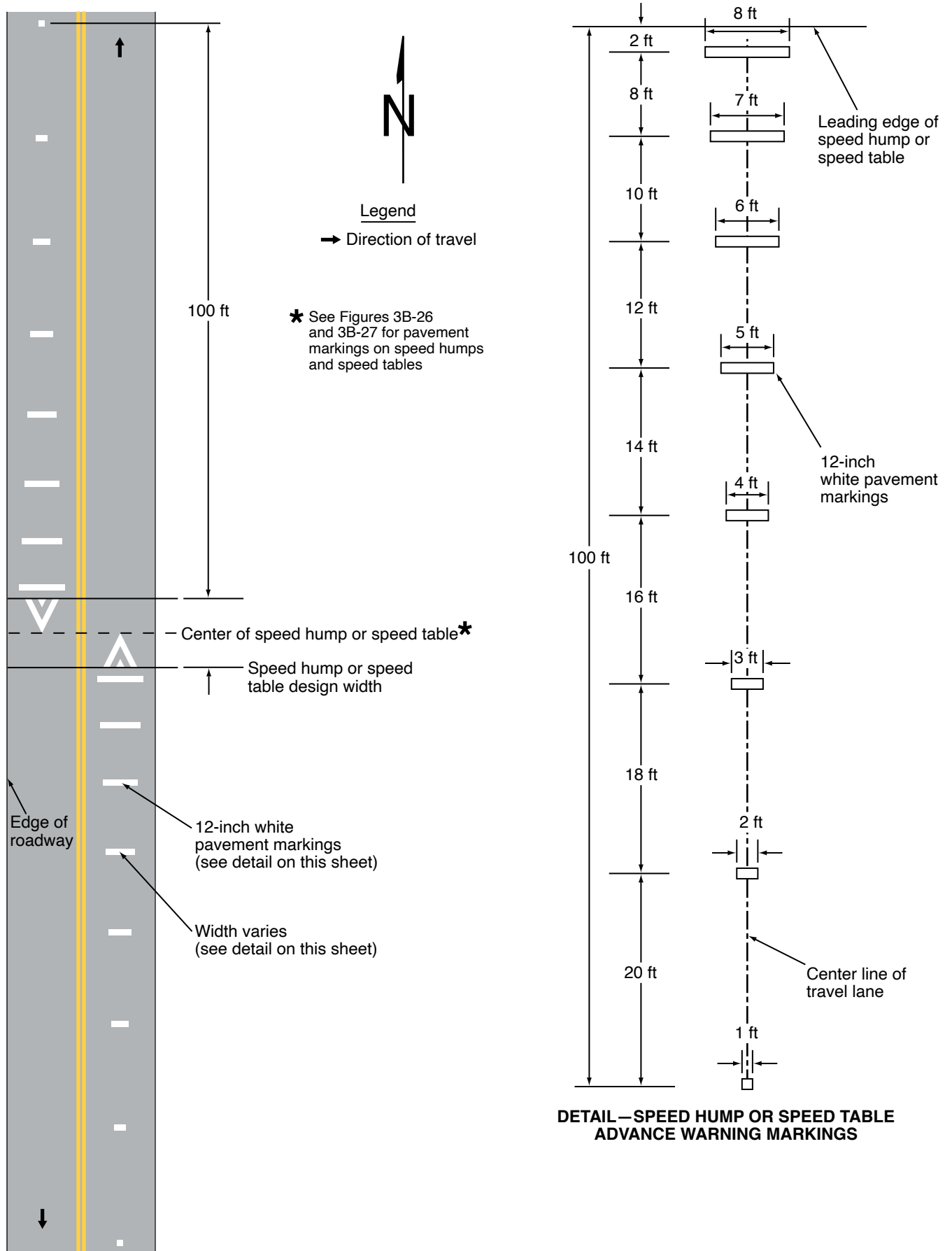
Guidance:

06 *Edge line and lane line extensions (see Section 3B.11) should be provided through the crossing points.*

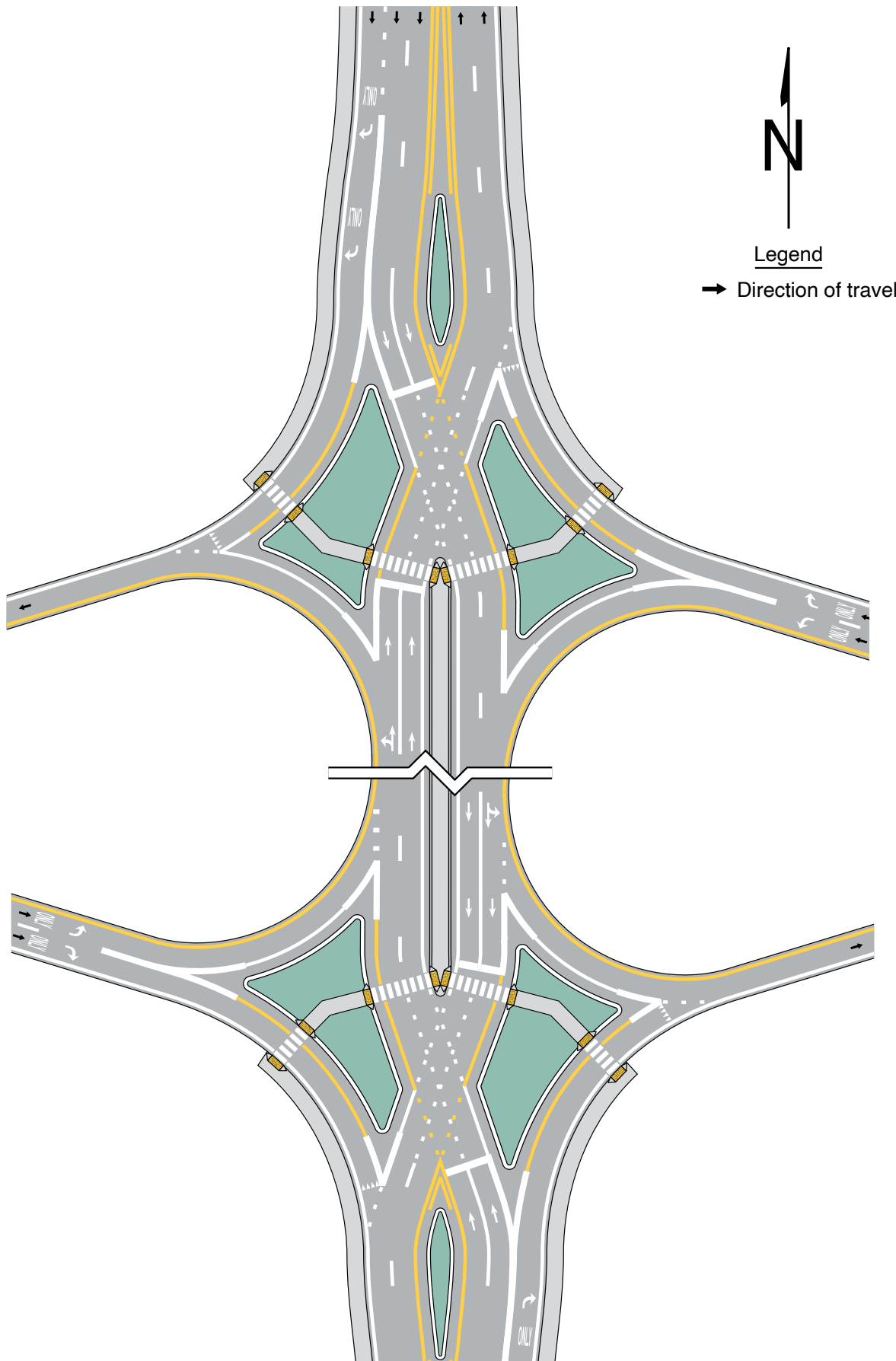
Support:

07 Figure 3B-29 illustrates an example of pavement markings for a diverging diamond interchange with a transposed alignment crossroad.

**Figure 3B-28. Advance Warning Markings for Speed Humps or Speed Tables**



**Figure 3B-29. Example of Pavement Markings for a Diamond Interchange with a Transposed Alignment Crossroad**



## CHAPTER 3C. CROSSWALK MARKINGS

### Section 3C.01 General

Support:

- 01 Crosswalk markings provide guidance for pedestrians who are crossing roadways by defining and delineating paths on approaches to and within signalized intersections, and on approaches to other intersections where traffic stops.
- 02 In conjunction with signs and other measures, crosswalk markings help to alert road users of a designated pedestrian crossing point across roadways at locations that are not controlled by traffic control signals or STOP or YIELD signs.
- 03 At non-intersection locations, crosswalk markings legally establish the crosswalk.
- 04 Detectable warning surfaces mark boundaries between pedestrian and vehicular ways where there is no raised curb. Detectable warning surfaces are typically installed where curb ramps are constructed at the junction of sidewalks and the roadway or shoulder, for marked and unmarked crosswalks. Detectable warning surfaces contrast visually with adjacent walking surfaces, either light-on-dark, or dark-on-light. The U.S. Department of Justice 2010 ADA Standards for Accessible Design, September 15, 2010, 28 CFR 35 and 36, Americans with Disabilities Act of 1990 contains specifications for the design of detectable warning surfaces.

### Section 3C.02 Application of Crosswalk Markings

Guidance:

- 01 *At locations controlled by traffic control signals, crosswalk markings should be installed.*

Option:

- 02 Crosswalk markings may be omitted if engineering judgment indicates they are not needed to direct pedestrians to the proper crossing path(s).

Guidance:

- 03 *On approaches controlled by STOP or YIELD signs, crosswalk markings should be installed where engineering judgment indicates they are needed to direct pedestrians to the proper crossing path(s).*
- 04 *At uncontrolled approaches, an engineering study should be performed before a marked crosswalk is installed. The following criteria should be considered:*
  - A. *Total number of approach lanes,*
  - B. *The presence of a median,*
  - C. *The distance from adjacent signalized intersections or other controlled crossings,*
  - D. *Projected pedestrian and bicyclist volumes,*
  - E. *Pedestrian and bicyclist paths of travel,*
  - F. *Pedestrian ages and abilities,*
  - G. *Pedestrian and bicyclist delays,*
  - H. *Location or frequency of public transit stops,*
  - I. *Average daily traffic (ADT),*
  - J. *Speed limit or the 85th-percentile speed,*
  - K. *The horizontal and vertical geometry of the crossing location,*
  - L. *The possible consolidation of multiple crossing points,*
  - M. *The availability of street lighting, and*
  - N. *Other appropriate factors.*

**Standard:**

- 05 **Crosswalk markings shall be provided at legally established crosswalks at non-intersection locations.**

Guidance:

- 06 *The installation of other traffic control devices and other measures designed to reduce traffic speeds, shorten crossing distances, enhance driver awareness of the crossing, and/or provide active warning of pedestrian presence, should be considered in addition to a new marked crosswalk and signs across an uncontrolled roadway where any of the following conditions exist:*
  - A. *The roadway has four or more lanes of travel without a raised median or pedestrian refuge island and an ADT of 12,000 vehicles per day or greater; or*
  - B. *The roadway has four or more lanes of travel with a raised median or pedestrian refuge island and an ADT of 15,000 vehicles per day or greater, or*
  - C. *The posted speed limit is 40 mph or greater, or*
  - D. *A crash study reveals that multiple-threat crashes are the predominant crash type on a multi-lane approach, or*
  - E. *When adequate visibility cannot be provided by parking prohibitions.*



Support:

- 07 Chapter 4J contains information on pedestrian hybrid beacons.
- 08 Chapter 4L contains information on rectangular rapid flashing beacons.
- 09 Section 4S.03 contains information regarding Warning Beacons to provide active warning of a pedestrian's presence.
- 10 Section 4U.02 contains information regarding In-Roadway Warning Lights at crosswalks.
- 11 Chapter 7C contains information on school crosswalks.
- 12 Chapter 7D contains information regarding school crossing supervision.
- 13 Section 9E.13 contains information on crosswalk markings for shared-use path crossings.

**Section 3C.03 Design of Crosswalk Markings**

Support:

- 01 Section 3B.19 contains information regarding placement of stop line markings and yield line markings near crosswalk markings.
- 02 Crosswalk markings are classified as either transverse line or high-visibility. Transverse crosswalk markings consist of two transverse lines. High-visibility markings consist of longitudinal lines parallel to traffic flow with or without transverse lines. Figure 3C-1 presents crosswalk marking designs.

**Standard:**

- 03 **Crosswalk markings shall be white. When used, transverse lines shall not be less than 6 inches or greater than 24 inches in width.**

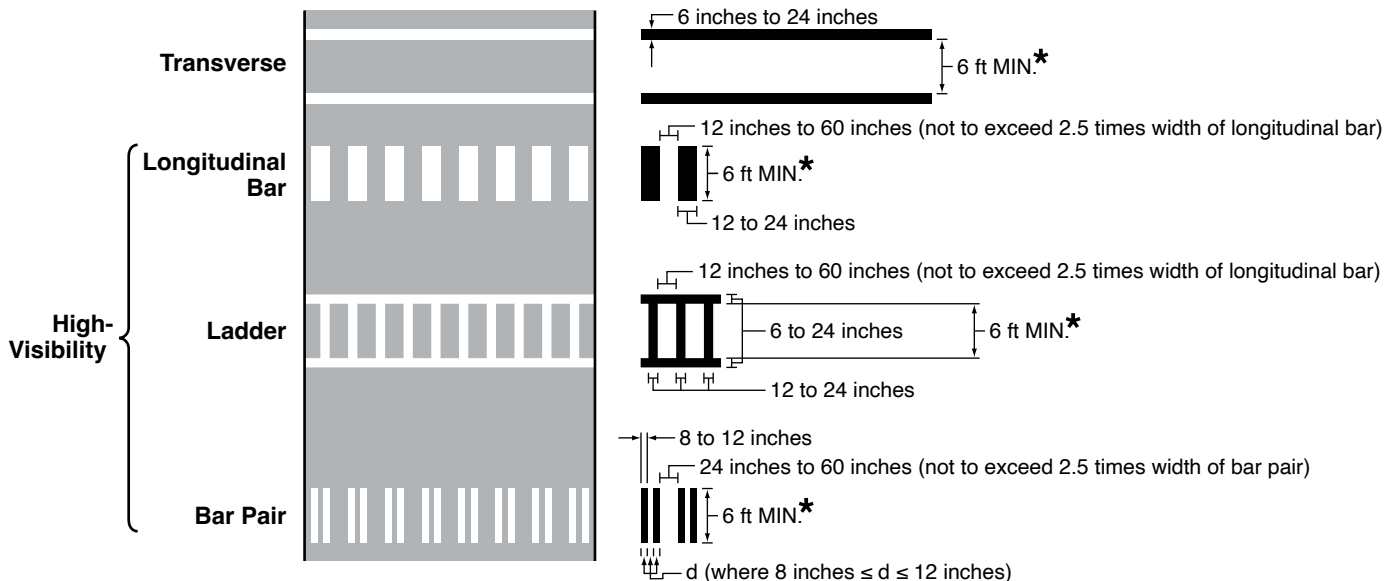
Support:

- 04 The allowable upper limit approaching 24 inches for the width of the transverse lines is normally applied where no stop or yield line is used in advance of the crosswalk or when approach speeds exceed 35 miles per hour.

**Standard:**

- 05 **Except as provided in Paragraph 6 of this Section, the minimum width of a marked crosswalk shall be 6 feet.**
- 06 **At a non-intersection crosswalk where the posted speed limit is 40 mph or greater, the minimum width of the crosswalk shall be 8 feet.**

**Figure 3C-1. Crosswalk Markings**



\* Minimum crosswalk width shall be 8 feet where the posted speed limit is 40 mph or greater at a non-intersection crosswalk.

*Guidance:*

- 07 *High-visibility crosswalk markings (such as shown in Figure 3C-1) and warning signs (see Section 2C.55) should be installed for all crosswalks at non-intersection locations.*
- 08 *Added visibility should be provided by parking prohibitions on the approach to marked crosswalks at non-intersection locations.*

**Standard:**

- 09 **Where curb ramps are provided, crosswalk markings shall be located so that the curb ramps are within the extension of the crosswalk markings.**

*Guidance:*

- 10 *Transverse line crosswalk markings should extend across the full width of pavement or to the edge of the intersecting crosswalk to discourage diagonal walking between crosswalks.*

## Support:

- 11 Provisions for aesthetic treatments for the interior portion of a legally-established crosswalk are contained in Section 3H.03.

**Standard:**

- 12 **If paving materials are used to function as the white transverse lines to establish a marked crosswalk, white additives shall be part of the mixture to produce a white surface. The white paving materials shall be retroreflective.**

**Section 3C.04 Transverse Line Crosswalks***Guidance:*

- 01 *Transverse line crosswalk markings should be limited to locations controlled by traffic control signals or on approaches controlled by STOP or YIELD signs.*

## Support:

- 02 Transverse line crosswalk marking design consists of two parallel transverse lines (see Figure 3C-1).
- 03 Transverse line crosswalk markings can provide benefits to crosswalk operations including:
- A. Define where the channelization of pedestrians or other non-motorized users is necessary to facilitate crossing the roadway.
  - B. Alert motorists to the location of where pedestrians and other non-motorized users might be expected when crossing the roadway.
  - C. Emphasize a crosswalk at a controlled intersection.
  - D. Fulfill a legal need to mark the crosswalk.

**Section 3C.05 High-Visibility Crosswalks**

## Option:

- 01 High-visibility crosswalk markings may be used where additional conspicuity is desired for a crosswalk over transverse line crosswalk markings.

## Support:

- 02 High-visibility crosswalk markings include the longitudinal bar, ladder, and bar pair designs (see Figure 3C-1).
- 03 High-visibility crosswalk markings can provide benefits to crosswalk operations including:
- A. Providing greater detection distances for the approaching motorist.
  - B. Emphasizing a crosswalk where substantial numbers of pedestrians cross without any other traffic control device.
  - C. Emphasizing a crosswalk at an uncontrolled approach.
  - D. Emphasizing the location where a high number of conflicts between turning motorists and users of the crosswalk are expected.
  - E. Improving visibility of the crosswalk location for otherwise difficult-to-detect pedestrians or other non-motorized users of the crosswalk.
  - F. Emphasizing a school crossing.

**Standard:**

- 04 **The minimum number of individual longitudinal elements to establish a high-visibility crosswalk shall be three. For the bar pair crosswalk design (see Section 3C.08), a coupling set of two longitudinal bars shall be considered to be one individual longitudinal element.**

*Guidance:*

- 05 *The dimensions of the individual longitudinal element and the lateral spacing between subsequent individual longitudinal elements for a high-visibility crosswalk should be uniform when establishing the crosswalk.*
- 06 *The dimensions of the individual longitudinal element and the lateral spacing between subsequent individual longitudinal elements for a high-visibility crosswalk should be uniform when establishing separate crosswalks on multiple approaches to the same intersection and on both sides of a median refuge if one is present.*
- 07 *The individual longitudinal elements of a high-visibility crosswalk should be angled such that they are parallel to the travel path of approaching traffic.*

## Option:

- 08 The lateral spacing between longitudinal elements may be staggered to avoid wheel paths, center lines, and lane lines.

**Section 3C.06 Longitudinal Bar Crosswalks**

## Support:

- 01 The longitudinal bar crosswalk marking design (see Figure 3C-1) provides for improved detection and recognition over the transverse line crosswalk for people with low vision and cognitive impairments.

**Standard:**

- 02 **The width of an individual longitudinal bar shall not be less than 12 inches or greater than 24 inches.**
- 03 **The lateral spacing between subsequent longitudinal bars shall not be less than 12 inches or greater than 60 inches. The lateral spacing of the longitudinal bars shall not exceed 2.5 times the width of a longitudinal bar.**

**Section 3C.07 Ladder Crosswalks**

## Support:

- 01 Ladder crosswalks (see Figure 3C-1) implement a pattern where interior longitudinal bars and transverse lines are used to define the limits of the crosswalk.
- 02 The ladder crosswalk marking design provides for improved detection and recognition over the transverse crosswalk for people with low vision and cognitive impairments.
- 03 Since the longitudinal component of the ladder crosswalk marking design is similar to the benefits provided by the longitudinal bar crosswalk design, the ladder crosswalk design is normally used to discourage or prohibit diagonal walking between crosswalks.

**Standard:**

- 04 **The transverse lines used to establish the limits of the ladder crosswalk shall not be less than 6 inches or greater than 24 inches in width.**
- 05 **The width of an individual interior longitudinal bar shall not be less than 12 inches or greater than 24 inches.**
- 06 **The lateral spacing between subsequent interior longitudinal bars shall not be less than 12 inches or greater than 60 inches. The lateral spacing of the interior longitudinal bars shall not exceed 2.5 times the width of an interior longitudinal bar.**

## Option:

- 07 Where it might be necessary to alleviate a parallax phenomenon due to approaching roadway geometry that curves or to accommodate low approach angles of the approaching motorist, the interior longitudinal bars may be rotated up to 45 degrees to the transverse lines to remain parallel to approaching traffic.

**Section 3C.08 Bar Pair Crosswalks**

## Support:

- 01 Bar pair crosswalks (see Figure 3C-1) can provide the same benefits as other high-visibility crosswalk designs with the opportunity for less maintenance.
- 02 Bar pair crosswalks can be useful in locations that are susceptible to slip and fall incidents exacerbated by extreme or inclement weather, or in locations where high motorcycle or bicycle use is expected, in order to maximize wheel traction with the road surface.

**Standard:**

- 03 The width of an individual longitudinal bar that establishes one-half of the bar pair shall not be less than 8 inches or greater than 12 inches. The lateral spacing between successive individual longitudinal bars within the same bar pair shall be equal to the width of one longitudinal bar.
- 04 The lateral spacing between subsequent longitudinal bar pairs shall not be less than 24 inches or greater than 60 inches, or 2.5 times the width of the total width of a bar pair.
- 05 Longitudinal bar pair crosswalks shall not be installed with accompanying transverse lines.

**Section 3C.09 Crosswalk Markings at Circular Intersections****Standard:**

- 01 Crosswalk markings shall not be provided to or from the central island of a roundabout.

*Guidance:*

- 02 If pedestrian facilities are provided, crosswalks should be marked across roundabout entrances and exits to indicate where pedestrians are intended to cross.
- 03 On an approach to a circular intersection controlled by a YIELD sign and at uncontrolled exits, crosswalks should be a minimum of 20 feet from the edge of the circulatory roadway.

*Support:*

- 04 Chapter 3D provides figures that illustrate examples of crosswalk markings for roundabouts.

**Section 3C.10 Crosswalks for Exclusive Pedestrian Phases that Permit Diagonal Crossings***Option:*

- 01 When an exclusive pedestrian phase that permits diagonal crossing of an intersection is provided at a traffic control signal, a marking as shown in Figure 3C-2 may be used for the crosswalk.

*Guidance:*

- 02 The segments of the crosswalk marking that facilitate the diagonal crossing should not use high-visibility crosswalk markings.

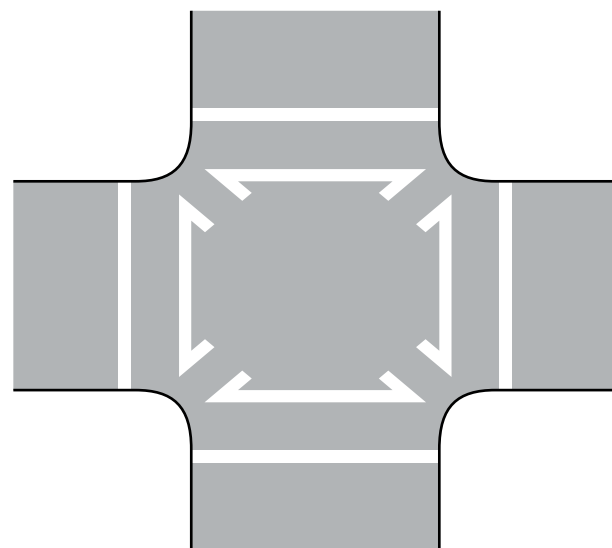
**Section 3C.11 Crosswalks at Diamond Interchanges with a Transposed Alignment Crossroad***Support:*

- 01 Diverging diamond interchanges, also known as double-crossover diamond interchanges, include directional crossovers on either side of the interchange that transpose the crossroad which results in vehicles traveling on the left-hand side of the street or highway between the crossover intersections. The potential for altered travel paths for pedestrians and the associated, unique, operational aspects such as traffic approaching from unexpected directions and unfamiliar signal phasing schemes are important considerations.

*Guidance:*

- 02 If pedestrian facilities are provided, pedestrian crossing movements of the crossroads at a diverging diamond interchange should be marked at the crossover intersections where motor vehicle traffic becomes transposed.
- 03 If pedestrian facilities are provided, crosswalks should be marked across ramp terminals at diverging diamond interchanges to indicate where pedestrians are intended to cross.
- 04 Crosswalks across diverging diamond interchange ramps with yield-controlled vehicle movements should be located a minimum of 20 feet from the edge of an intersecting ramp.

**Figure 3C-2. Example of Crosswalk Markings for an Exclusive Pedestrian Phase that Permits Diagonal Crossings**



Note: High-visibility crosswalks can be used for the crosswalks around the perimeter of the intersection

## Support:

- 05 Section 3B.31 contains information on markings, such as edge lines, lane lines, and lane-use arrows, for diverging diamond interchanges.
- 06 Figure 3B-29 shows an example of pedestrian crossing locations at a diverging diamond interchange.

**Section 3C.12 Pedestrian Islands and Medians**

## Support:

- 01 Raised islands or raised medians of sufficient width that are placed in the center area of a street or highway can serve as a place of refuge for pedestrians who are attempting to cross at a midblock or intersection location. Center islands or medians allow pedestrians to find an adequate gap in one direction of traffic at a time, as the pedestrians are able to stop, if necessary, in the center island or median area and wait for an adequate gap in the other direction of traffic before crossing the second half of the street or highway. The U.S. Department of Justice 2010 ADA Standards for Accessible Design, September 15, 2010, 28 CFR 35 and 36, Americans with Disabilities Act of 1990 contains specifications for the design of detectable warning surfaces and provides technical requirements that can be used to determine the minimum width for accessible refuge islands.

## CHAPTER 3D. CIRCULAR INTERSECTION MARKINGS

### Section 3D.01 General

#### Guidance:

- 01 *Pavement markings and signing for a circular intersection should be integrally designed to correspond to the geometric design and intended lane use of a circular intersection.*
- 02 *Markings on the approaches to a circular intersection and on the circulatory roadway should be compatible with each other to provide a consistent message to road users. The markings should supplement the signing, both conveying the optional and mandatory movements such that road users will know to choose the proper lane in the approach to the circular intersection and remain in that lane throughout departure from the circulatory roadway.*

#### Support:

- 03 Common circular intersection types include roundabouts, rotaries, and traffic circles (see definitions in Section 1C.02). Traffic circles and rotaries are often much larger than roundabouts. Modern roundabouts feature channelized, curved approaches that reduce vehicle speed. Traffic calming circles are smaller and are typically used on urban or suburban neighborhood streets.
- 04 Figure 3D-1 provides an example of the pavement markings for approach and circulatory roadways at a roundabout. Figures 3D-2 through 3D-8 illustrate examples of markings for roundabouts of various geometric and lane-use configurations.
- 05 Actuated LED pedestrian warning signs (see Section 2A.12), traffic control signals, pedestrian hybrid beacons, and rectangular rapid flashing beacons (see Part 4) are sometimes used at roundabouts to facilitate the crossing of pedestrians or to meter traffic.
- 06 Section 8A.12 provides information about circular intersections that contain or are in close proximity to grade crossings.
- 07 Section 9E.05 contains information regarding bicycle lane markings at circular intersections.
- 08 Section 3C.09 contains information regarding crosswalks at circular intersections.

### Section 3D.02 White Lane Line Pavement Markings for Roundabouts

#### Standard:

- 01 **Multi-lane approaches to roundabouts shall have lane lines.**
- 02 **A through lane on a roadway that becomes a dropped lane (mandatory left-turn or right-turn lane) at a roundabout shall be marked with a dotted white lane line in accordance with Section 3B.07.**

#### Guidance:

- 03 *Multi-lane roundabouts should have lane line markings within the circulatory roadway to continuously channelize traffic in the circulatory roadway and through the departure movement.*

#### Standard:

- 04 **Continuous concentric lane lines shall not be used within the circulatory roadway of a roundabout.**

#### Option:

- 05 Channelizing lines (see Section 3B.08) and chevron and diagonal markings (see Section 3B.25) may be used on the approaches to and within the circulatory roadway of multi-lane roundabouts to separate traffic lanes, discourage lane changing, and/or compensate for off-tracking of larger trucks and vehicles.

#### Support:

- 06 Reducing the spacing between lines of a broken lane line allows better delineation of the lower-radius curves typically found in circular intersections.

### Section 3D.03 Edge Line Pavement Markings for Roundabout Circulatory Roadways

#### Guidance:

- 01 *A white edge line should be used on the outer (right-hand) edge of the circulatory roadway.*
- 02 *Where a white edge line is used for the circulatory roadway, it should be as follows (see Figure 3D-1):*
- A. *A solid line adjacent to the splitter island, and*
  - B. *A wide dotted line across the lane(s) entering the roundabout.*

#### Standard:

- 03 **Edge lines and edge line extensions shall not be placed across the exits from the circulatory roadway at roundabouts.**

#### Option:

- 04 A yellow edge line may be placed around the inner (left-hand) edge of the circulatory roadway (see Figure 3D-1) and may be used to channelize traffic (see Drawing B in Figure 3D-3).

**Figure 3D-1. Example of Markings for Approach and Circulatory Roadways at a Roundabout**

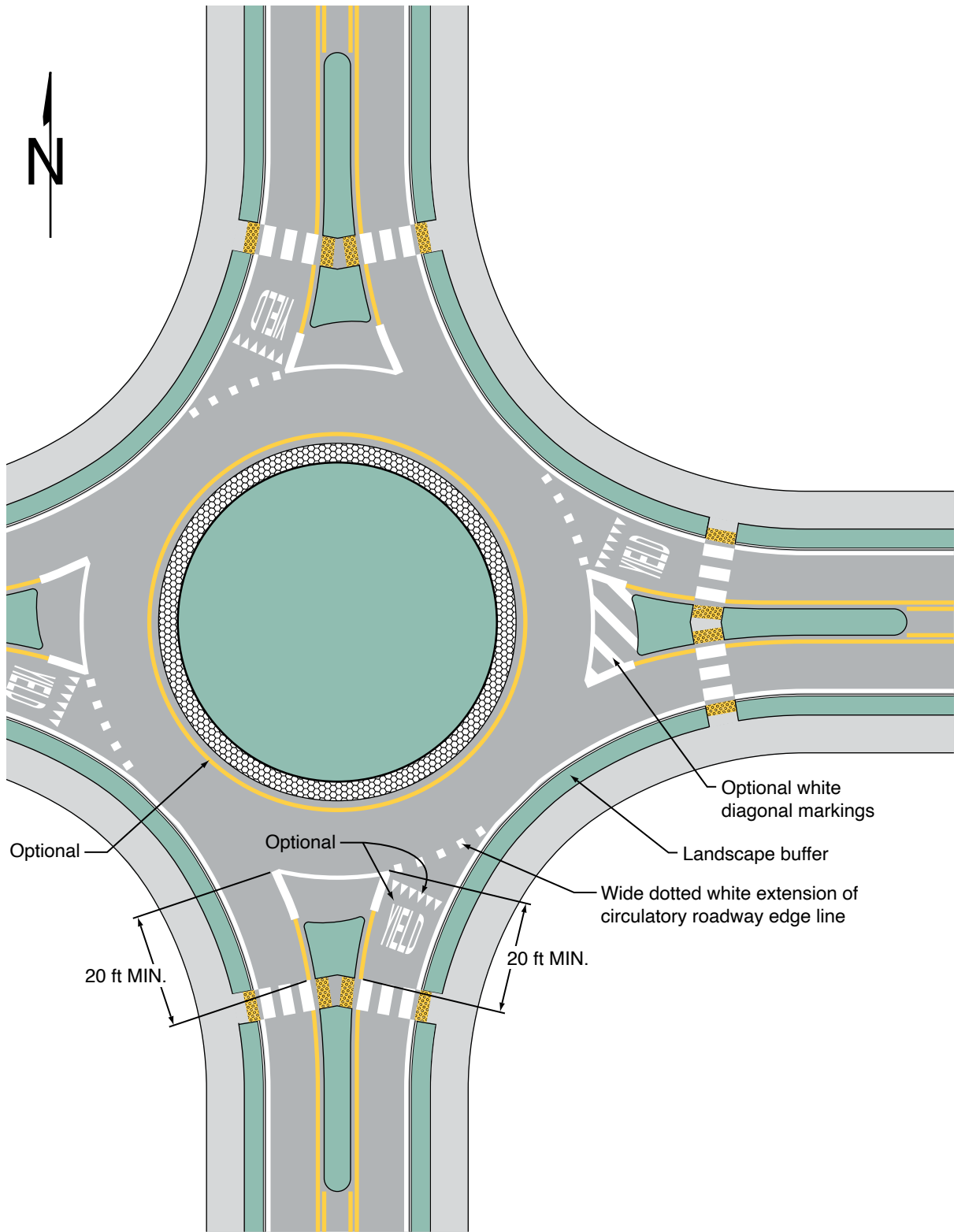
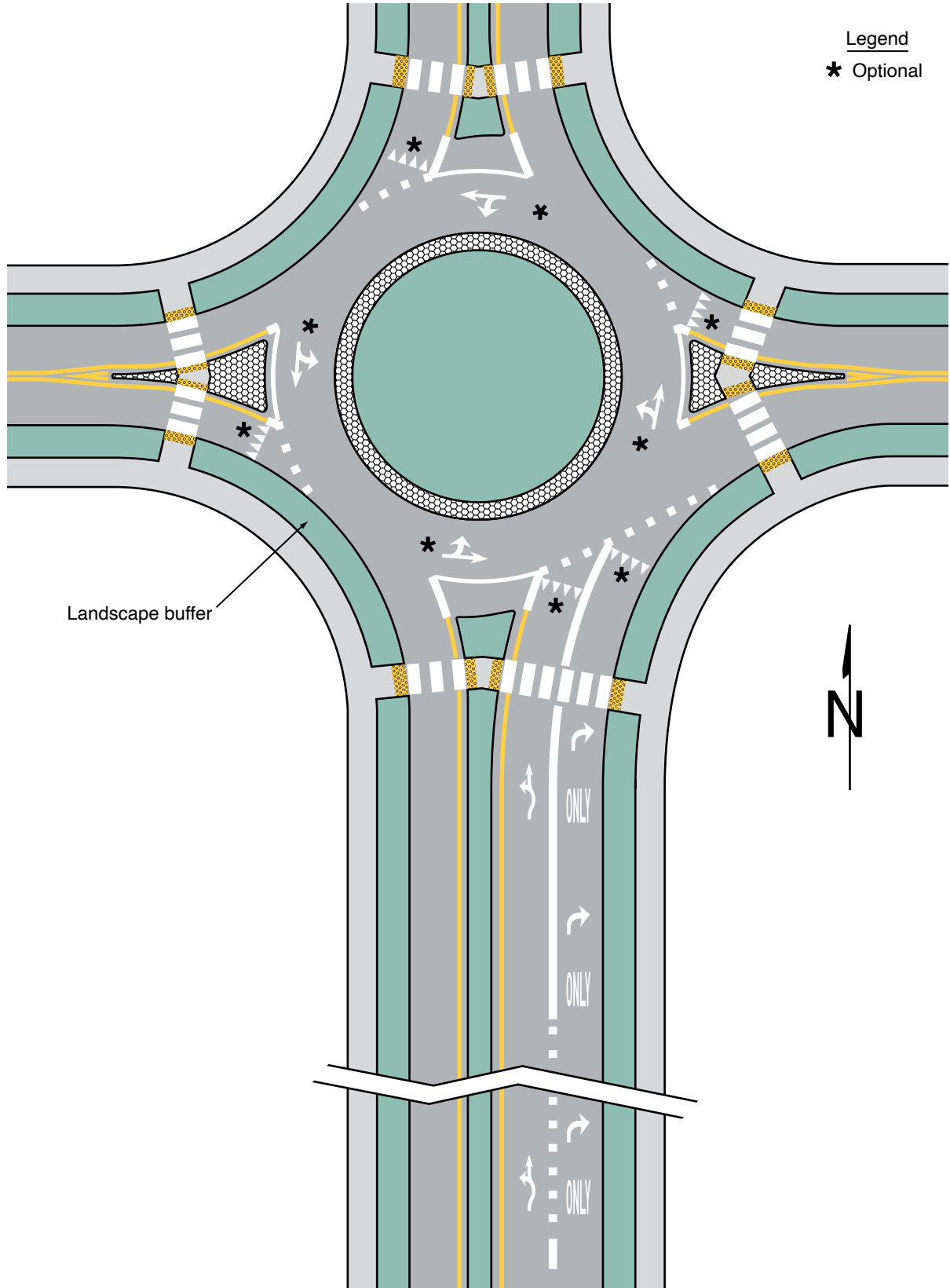


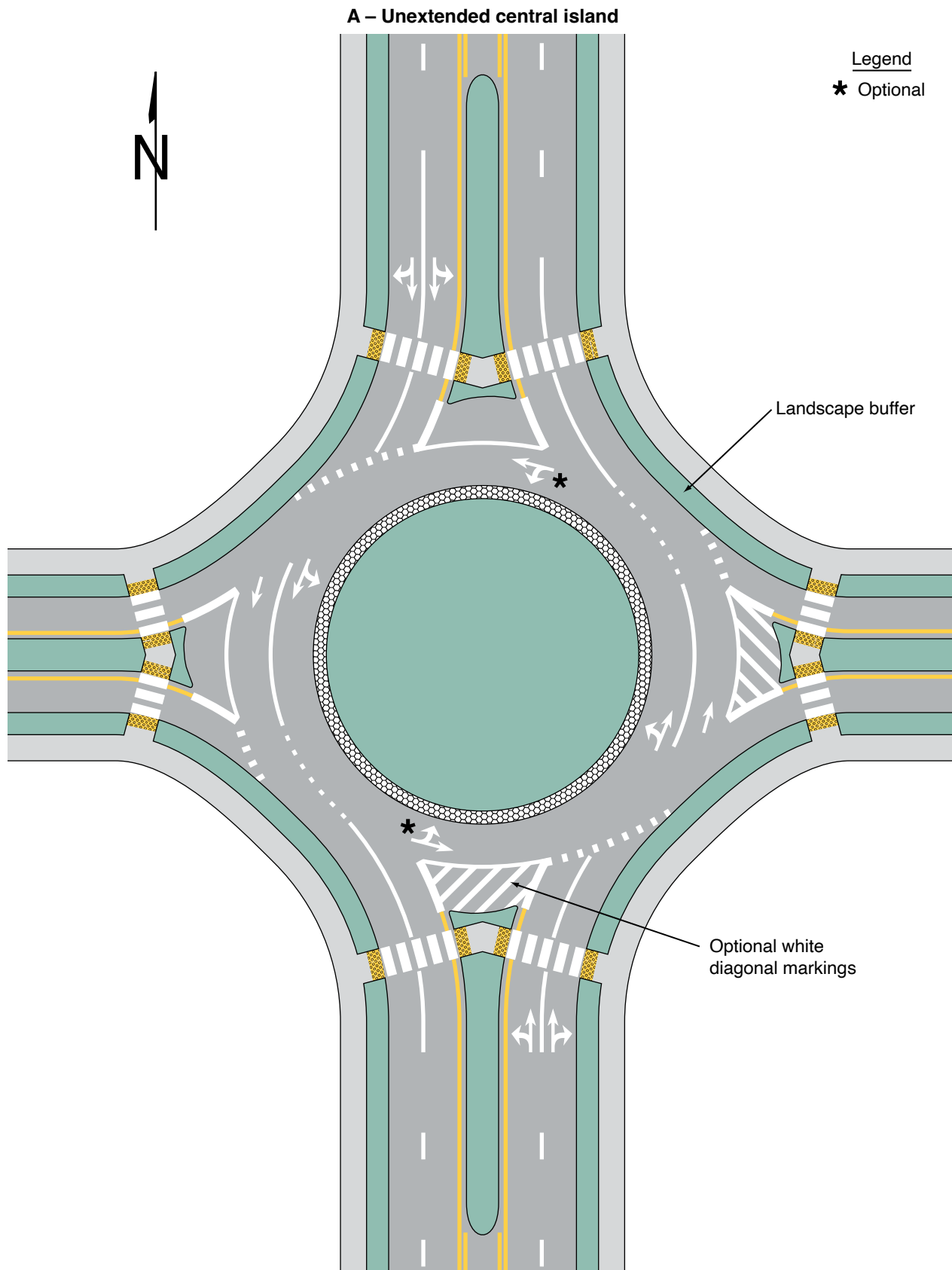


Figure 3D-2. Example of Markings for a One-Lane Roundabout



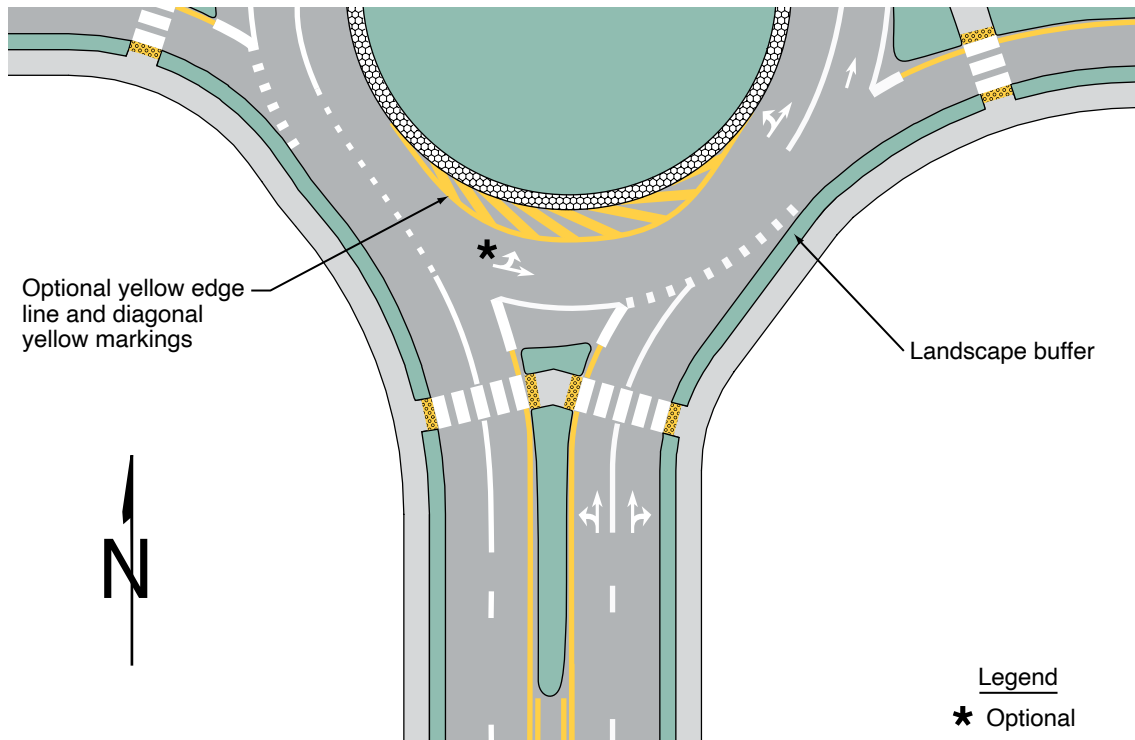


**Figure 3D-3. Example of Markings for a Two-Lane Roundabout with One-Lane and Two-Lane Approaches (Sheet 1 of 2)**

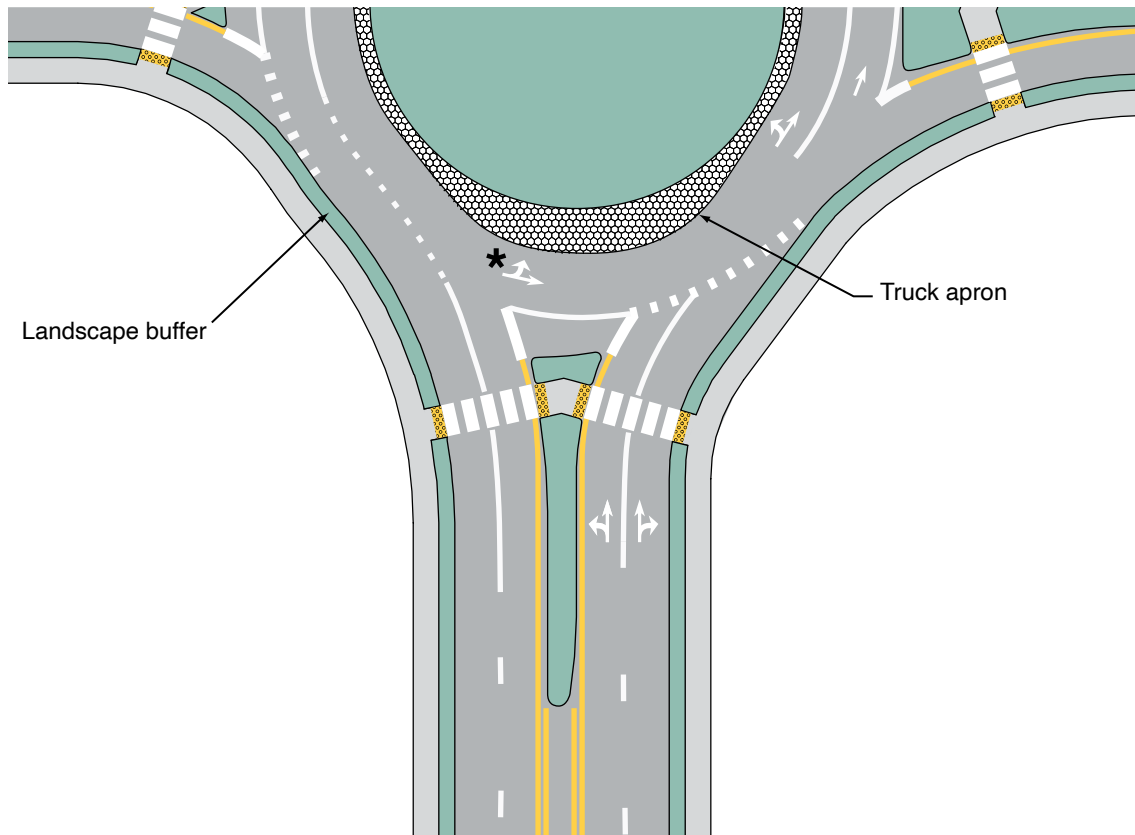


**Figure 3D-3. Example of Markings for a Two-Lane Roundabout with One-Lane and Two-Lane Approaches (Sheet 2 of 2)**

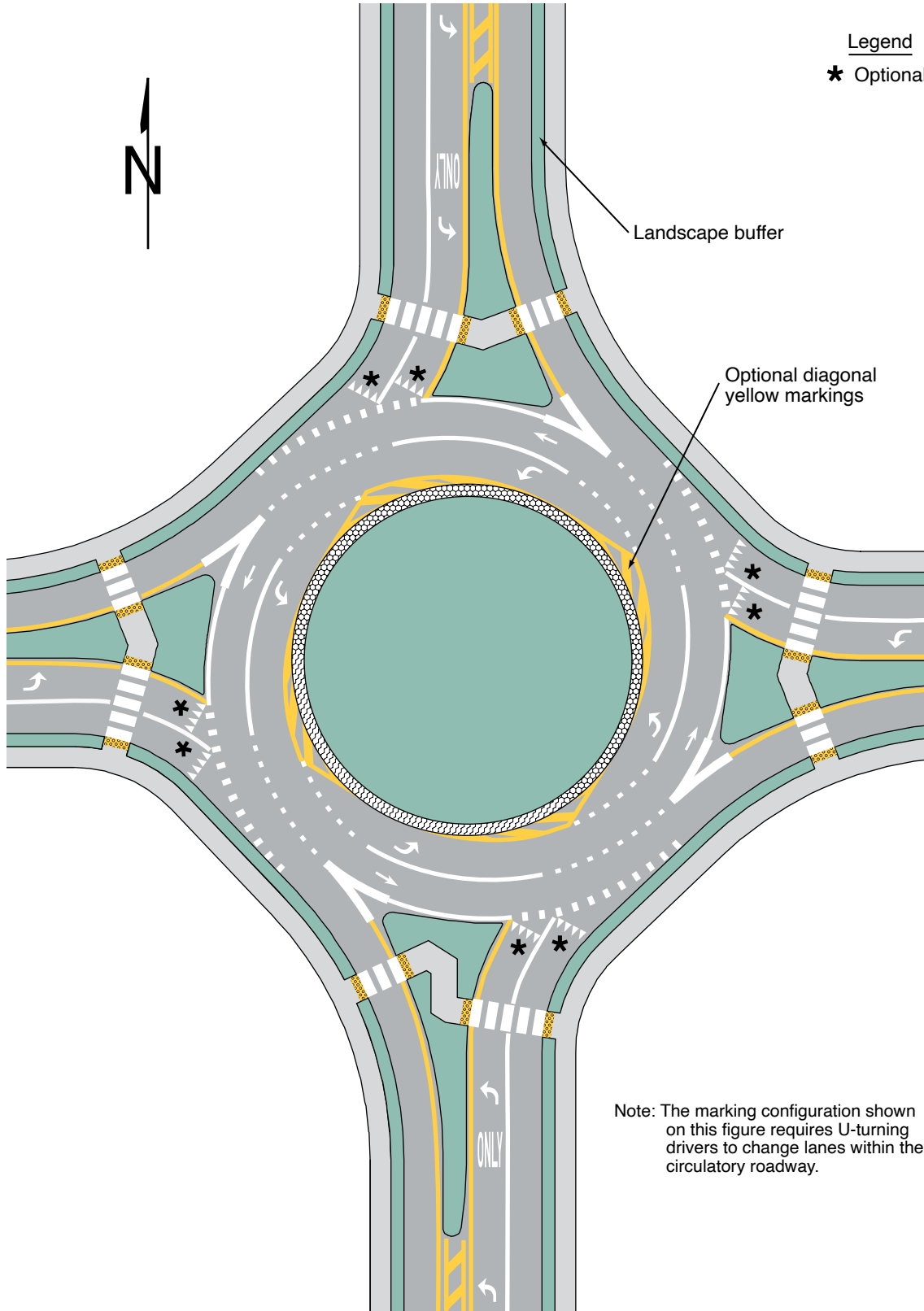
**B – Central island extended by pavement markings**



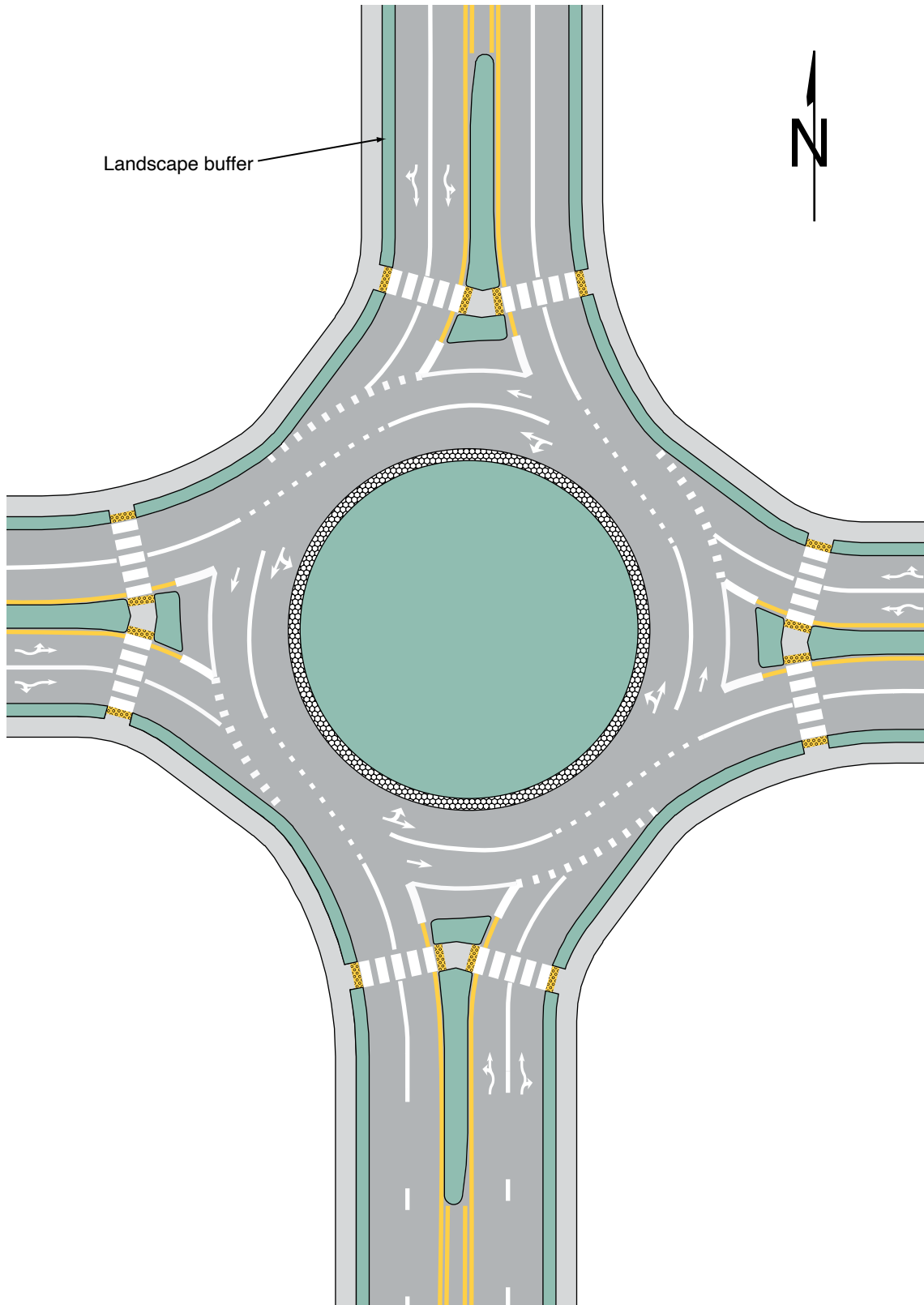
**C – Central island extended by a truck apron**



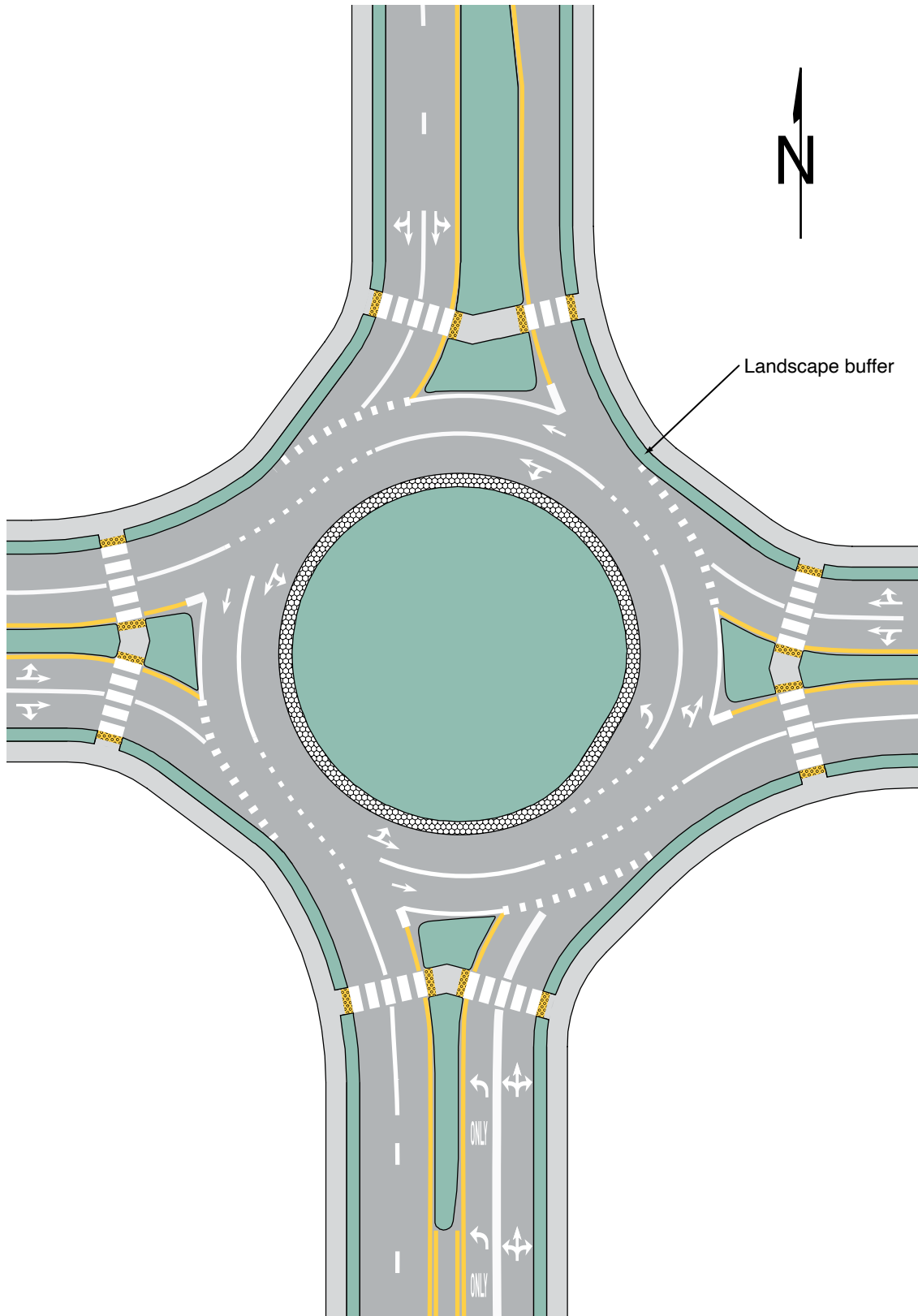
**Figure 3D-4. Example of Markings for a Two-Lane Roundabout with One-Lane Exits**



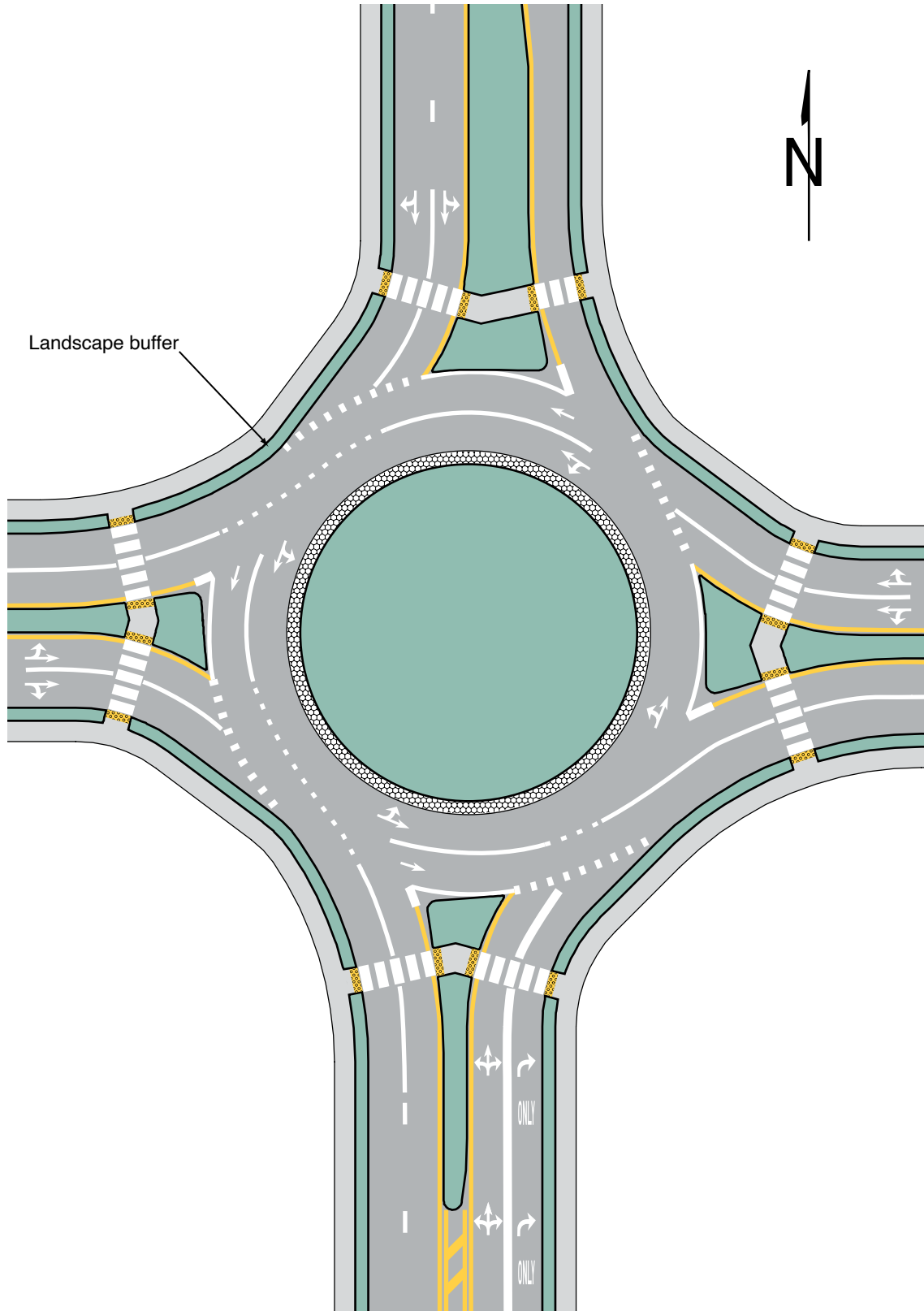
**Figure 3D-5. Example of Markings for a Two-Lane Roundabout with Two-Lane Exits**



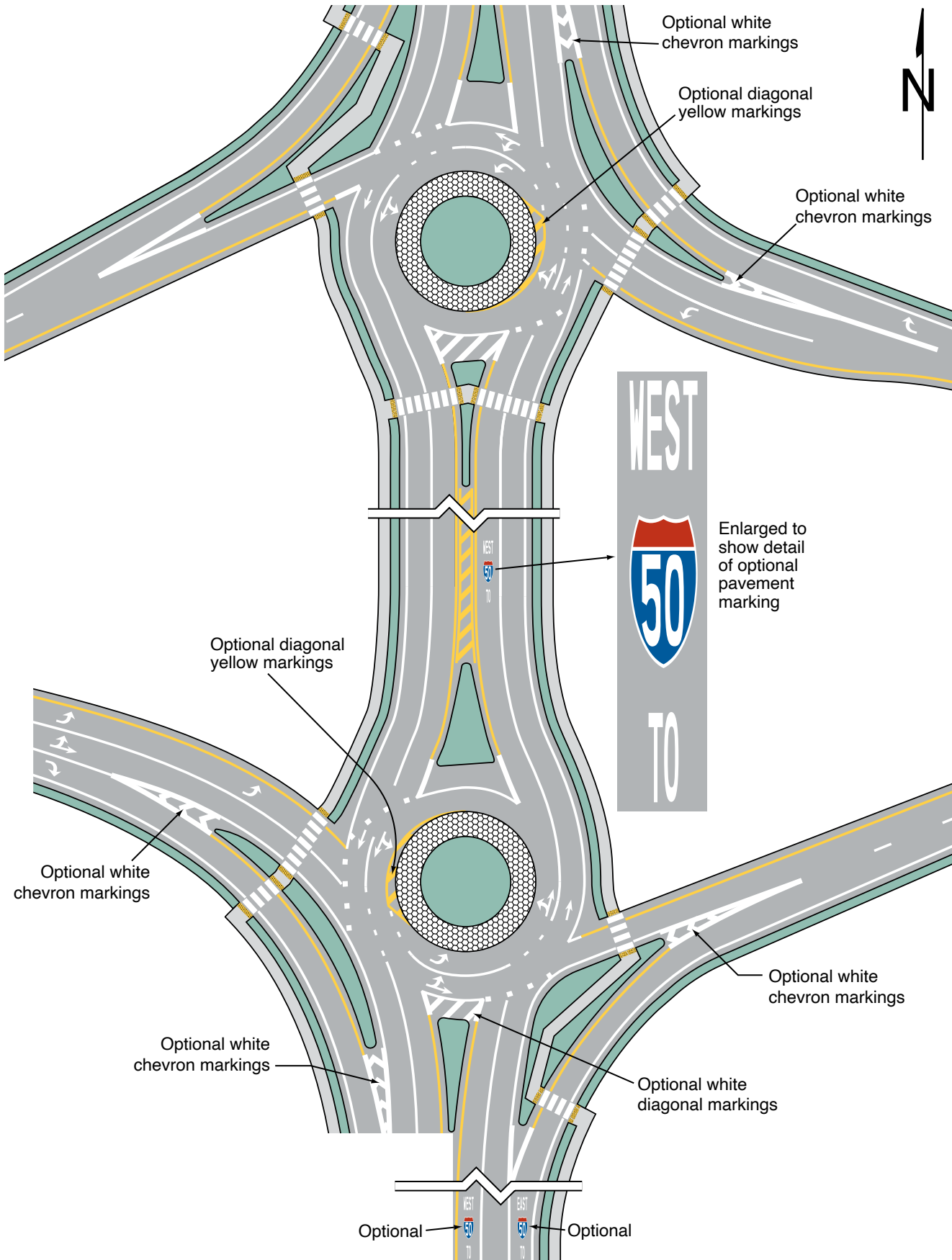
**Figure 3D-6. Example of Markings for a Two-Lane Roundabout with a Double Left Turn**



**Figure 3D-7. Example of Markings for a Two-Lane Roundabout with a Double Right Turn**



**Figure 3D-8. Example of Markings for a Diamond Interchange with Two Circular-Shaped Roundabout Ramp Terminals**



**Section 3D.04 Yield Lines for Roundabouts**

## Support:

- 01 Section 2B.18 contains information regarding the TO ALL LANES (R1-2cP) plaque that can be used beneath the YIELD sign.

## Option:

- 02 A yield line (see Section 3B.19) may be used to indicate the point behind which vehicles are required to yield at the entrance to a roundabout (see Figures 3D-1 and 3D-2).

**Section 3D.05 Word and Symbol Pavement Markings for Roundabouts**

## Option:

- 01 YIELD (word) (see Figure 3D-1) and YIELD AHEAD (symbol or word) pavement markings may be used on approaches to roundabouts.
- 02 Word and/or route shield pavement markings may be used on an approach to or within the circulatory roadway of a roundabout to provide route and/or destination guidance information to road users (see Figure 3D-8).

**Section 3D.06 Arrow Pavement Markings for Roundabouts***Guidance:*

- 01 *Lane-use arrow pavement markings should not be used on single-lane approaches to circular intersections.*
- 02 *Lane-use arrows should be used on approaches to circular intersections with double left or double right turns.*

**Standard:**

- 03 **Lane-use arrow pavement markings shall not be provided between a crosswalk and a wide dotted line across the lane(s) entering the circular roadway.**

## Option:

- 04 Where lane-use arrows are used on the approaches to a roundabout, they may be either normal or curved-stem (see Drawing F in Figure 3B-21).
- 05 An oval or circle may be used with the lane-use arrows to symbolize the central island (see Drawing F in Figure 3B-21).

*Guidance:*

- 06 *If lane-use arrows are used on the approaches to a roundabout, the style used should match the style of the lane-use arrows (normal or curved-stem) used on the regulatory lane-use signs on the approach.*
- 07 *If lane-use arrow pavement markings are used within the circulatory roadway of multi-lane roundabouts, normal lane-use arrows (see Section 3B.23 and Figure 3B-21) should be used.*

## Support:

- 08 Details and sizes of the standard and curved-stem arrows that can be used for circular intersections are contained in the “Standard Highway Signs” publication (see Section 1A.05).

**Section 3D.07 Markings for Other Circular Intersections**

## Option:

- 01 The markings shown in this Chapter may be used at other circular intersections if engineering judgment indicates that their presence will benefit drivers, pedestrians, or other road users. Figure 2B-21 provides an example of markings at a mini-roundabout.



## CHAPTER 3E. PREFERENTIAL LANE MARKINGS FOR MOTOR VEHICLES

### Section 3E.01 General

Support:

- 01 Preferential lanes are established for one or more of a wide variety of special uses, including, but not limited to, high-occupancy vehicle (HOV) lanes, electronic toll collection (ETC) lanes, price-managed lanes, bus only lanes, taxi only lanes, and light rail transit only lanes.
- 02 This Chapter contains the pavement marking provisions for preferential lanes used by motor vehicles and light rail transit. Part 9 contains information for pavement markings for bicycle lanes.
- 03 Chapter 3H contains information for the use and application of colored pavement that can be used in preferential lanes to supplement the pavement markings described in this Chapter.

### Section 3E.02 Longitudinal Markings

Support:

- 01 Preferential lanes can take many forms depending on the level of usage and the design of the facility. They might be barrier-separated or buffer-separated from the adjacent general-purpose lanes, or they might be contiguous with the adjacent general-purpose lanes. Barrier-separated preferential lanes might be operated in a constant direction or be operated as reversible lanes. Some reversible preferential lanes on a divided highway might be operated counter-flow to the direction of traffic on the immediately adjacent general-purpose lanes. Section 1C.02 contains definitions of these terms.
- 02 Preferential lanes might be operated full-time (24 hours per day on all days), for extended periods of the day, part-time (restricted usage during specific hours on specified days), or on a variable basis (such as a strategy for a managed lane).

**Standard:**

- 03 **The left-hand and right-hand edge lines and lane lines used for preferential lanes that are adjacent to general-purpose lanes where traffic is flowing in the same direction shall be in accordance with Table 3E-1.**
- 04 **If there are two or more preferential lanes for traffic moving in the same direction, the lane lines between the preferential lanes shall be normal width broken white lines.**
- 05 **Preferential lanes for motor vehicles shall have appropriate regulatory signs in accordance with Sections 2G.03 through 2G.07.**

Support:

- 06 Figure 3E-1 illustrates pavement markings used for barrier-separated preferential lanes. Figure 3E-2 illustrates pavement markings used for buffer-separated preferential lanes. Figure 3E-3 illustrates pavement markings used for contiguous preferential lanes.

*Guidance:*

- 07 *Engineering judgment should determine the need for supplemental devices such as tubular markers, traffic cones, or other channelizing devices (see Chapter 3I).*
- 08 *Where preferential lanes and other travel lanes are separated by a buffer space wider than 4 feet and crossing the buffer space is prohibited, chevron markings (see Section 3B.25) should be placed in the buffer area (see Drawing A in Figure 3E-2).*
- 09 *The buffer space for a conventional road should be designed so that it is not misinterpreted as on-street parking, a bicycle lane, or any other type of lane.*

Option:

- 10 If a full-time or part-time contiguous preferential lane is separated from the other travel lanes by a wide broken single white line (see Drawing C in Figure 3E-3), the spacing or skip pattern of the line may be reduced and the width of the line may be increased.

Support:

**Standard:**

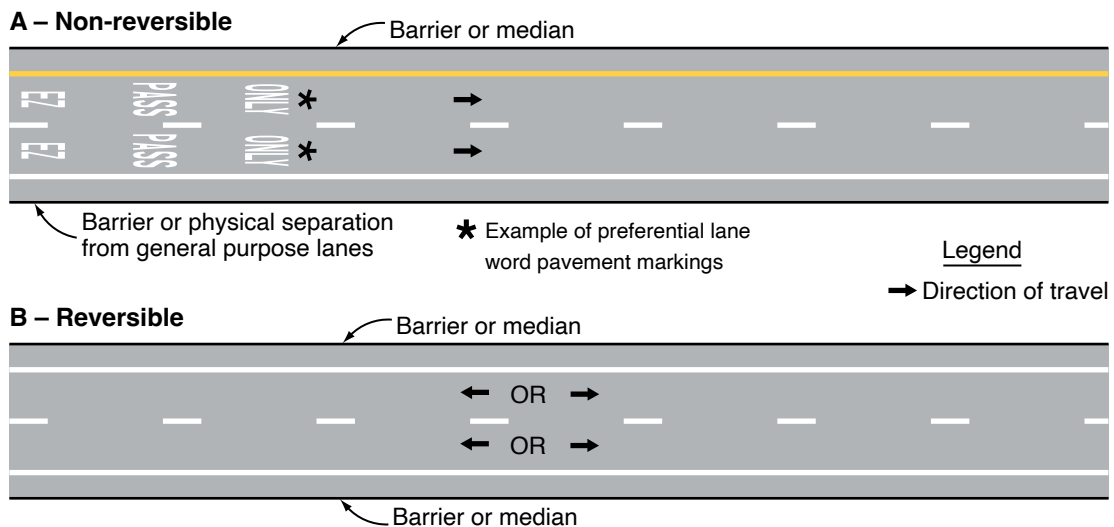
- 11 **At direct exits from a preferential lane, dotted white line markings shall be used to separate the tapered or parallel deceleration lane for the direct exit (including the taper) from the adjacent continuing preferential through lane, to reduce the chance of unintended exit maneuvers.**
- 12 **Signs (see Section 2B.34), lane-use control signals (see Chapter 4T), or both shall be used to supplement the reversible lane markings on a divided highway where a part-time counter-flow preferential lane is present.**

**Table 3E-1. Standard Edge Line and Lane Line Markings for Preferential Lanes**

| Type of Preferential Lane         | Left-Hand Line   | Right-Hand Line  |
|-----------------------------------|--|--|
| Barrier-Separated, Non-Reversible | A normal solid single yellow edge line   | A normal solid single white edge line (see Drawing A in Figure 3E-1)   |
| Barrier-Separated, Reversible     | A normal solid single white edge line  | A normal solid single white edge line (see Drawing B in Figure 3E-1)   |
| Buffer-Separated, Left-Hand Side  | A normal solid single yellow edge line   | A wide solid double white line along both edges of the buffer space where crossing is prohibited (see Drawing A in Figure 3E-2)<br>A wide solid single white line along both edges of the buffer space where crossing is discouraged (see Drawing B in Figure 3E-2)<br>A wide broken single white line along both edges of the buffer space, or a wide broken single white line within the buffer space (resulting in wider lanes), where crossing is permitted (see Drawing C in Figure 3E-2) |
| Buffer-Separated, Right-Hand Side | A wide solid double white line along both edges of the buffer space where crossing is prohibited, or a wide solid single white line along both edges of the buffer space where crossing is discouraged (see Drawing D in Figure 3E-2)<br>A wide broken single white line along both edges of the buffer space, or a wide broken single white line within the buffer space (resulting in wider lanes), where crossing is permitted (see Drawing D in Figure 3E-2)<br>A wide dotted single white line within the buffer space (resulting in wider lanes) where crossing is permitted for any vehicle to perform a right-turn maneuver (see Drawing D in Figure 3E-2) | A normal solid single white edge line (if warranted)   |
| Contiguous, Left-Hand Side        | A normal solid single yellow edge line   | A wide solid double white lane line where crossing is prohibited (see Drawing A in Figure 3E-3)<br>A wide solid single white lane line where crossing is discouraged (see Drawing B in Figure 3E-3)<br>A wide broken single white lane line where crossing is permitted (see Drawing C in Figure 3E-3)   |
| Contiguous, Right-Hand Side       | A wide solid double white lane line where crossing is prohibited (see Drawing D in Figure 3E-3)<br>A wide solid single white lane line where crossing is discouraged (see Drawing D in Figure 3E-3)<br>A wide broken single white lane line where crossing is permitted (see Drawing D in Figure 3E-3)<br>A wide dotted single white lane line where crossing is permitted for any vehicle to perform a right-turn maneuver (see Drawing D in Figure 3E-3)   | A normal solid single white lane line (if warranted)   |

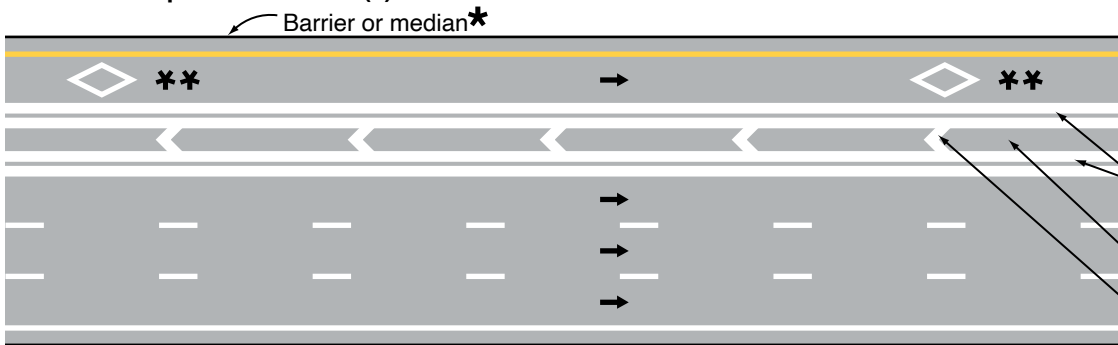
Notes: 1. If there are two or more preferential lanes, the lane lines between the preferential lanes shall be normal broken white lines.  
2. The standard lane markings listed in this table are provided in a tabular format for reference.

**Figure 3E-1. Markings for Barrier-Separated Preferential Lanes**

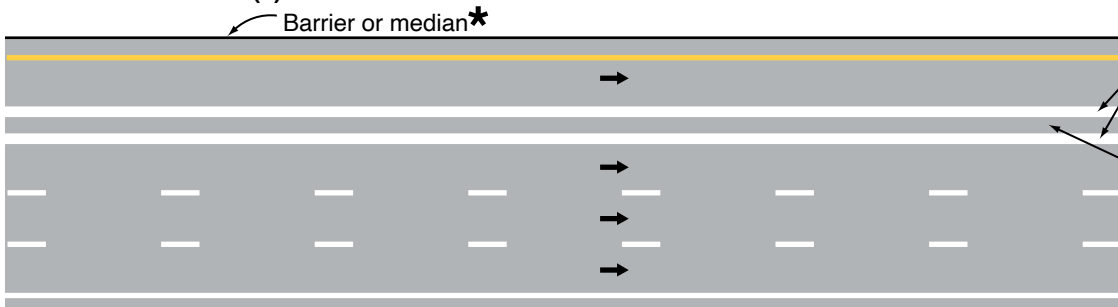


**Figure 3E-2. Markings for Buffer-Separated Preferential Lanes (Sheet 1 of 2)**

**A – Full-time preferential lane(s) where enter/exit movements are PROHIBITED**



**B – Preferential lane(s) where enter/exit movements are DISCOURAGED**



Wide solid double white lane lines  
Buffer space  
White chevron markings if buffer space is wider than 4 feet

Wide solid single white lane lines  
Buffer space

- Legend**
- ➔ Direction of travel
  - ★ If no barrier or median is present and the left-hand side of the lane is the center line of a two-way roadway, use a double yellow center line
  - ★★ Example of HOV only lane symbol markings. Space at 1/4-mile intervals or as determined by engineering judgment (see Section 3E.03)

13 **The longitudinal pavement markings used for preferential lanes that are adjacent to general-purpose lanes where traffic is flowing in the opposite direction (see Figure 3E-4) shall be in accordance with Table 3E-2.**

Support:

14 Figure 3E-4 illustrates pavement markings used for counter-flow preferential lanes on divided highways or on transitions to and from other divided highways such as bridges and crossovers.

Option:

15 Cones, tubular markers, or other channelizing devices (see Chapter 3I) may also be used in addition to longitudinal markings to separate the opposing lanes when a counter-flow preferential lane operation is in effect.

**Section 3E.03 Preferential Lane Word and Symbol Markings**

Support:

01 Sections 3B.20 through 3B.22 contain information on general applications of word and symbol markings.

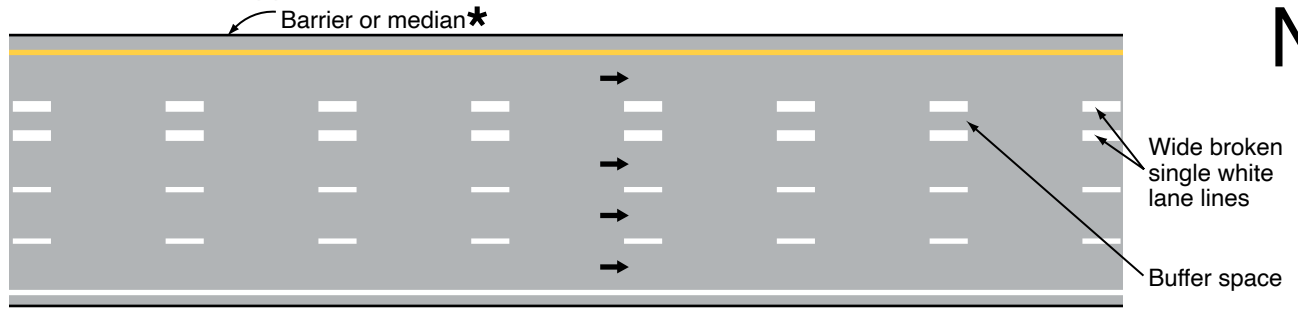
**Standard:**

02 **When a preferential lane is established, the preferential lane shall be marked with one or more of the following word or symbol markings for the preferential lane use specified:**

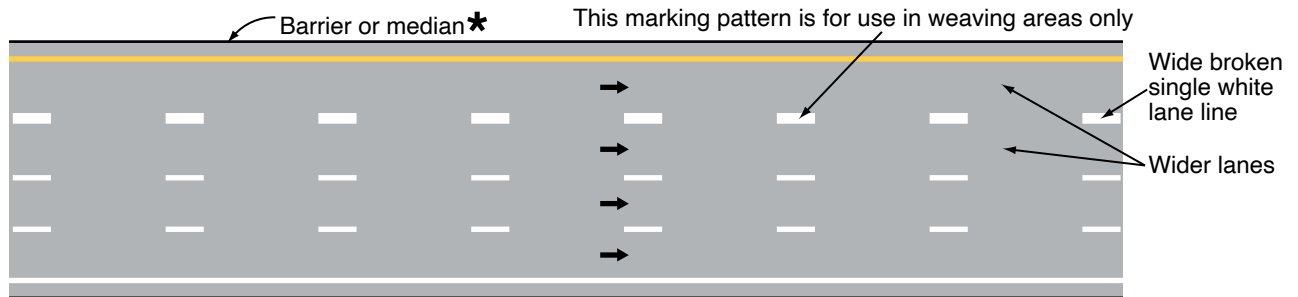
- A. **HOV lane**—white lines formed in a diamond-shaped symbol or the word message HOV. The diamond shall be at least 2.5 feet wide and 12 feet in length. The lines shall be at least 6 inches in width.
- B. **ETC Account-Only lane**—except as provided in Paragraph 8 of this Section, a word marking or pictograph using the name of the ETC payment system required for use of the lane, such as E-Z PASS ONLY.
- C. **Price-managed lane**—the word marking EXPRESS or EXPRESS LANE(S) (see Section 2G.17).
- D. **Bus only lane or bus stop**—the word marking BUS ONLY or BUS STOP.
- E. **Taxi only lane or taxi stand** —the word marking TAXI ONLY or TAXI STAND.
- F. **Light rail transit lane**—the word marking LRT ONLY.
- G. **Other type of preferential lane**—a word marking appropriate to the restriction.

**Figure 3E-2. Markings for Buffer-Separated Preferential Lanes (Sheet 2 of 2)**

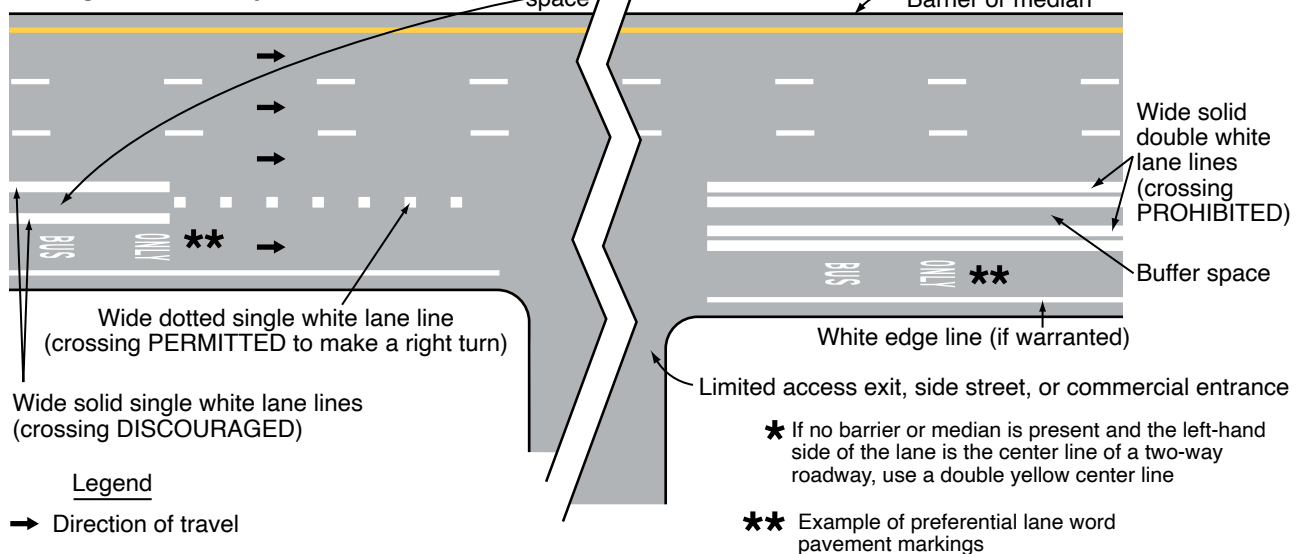
**C – Preferential lane(s) where enter/exit movements are PERMITTED**



OR



**D – Right-hand side preferential lane(s)**



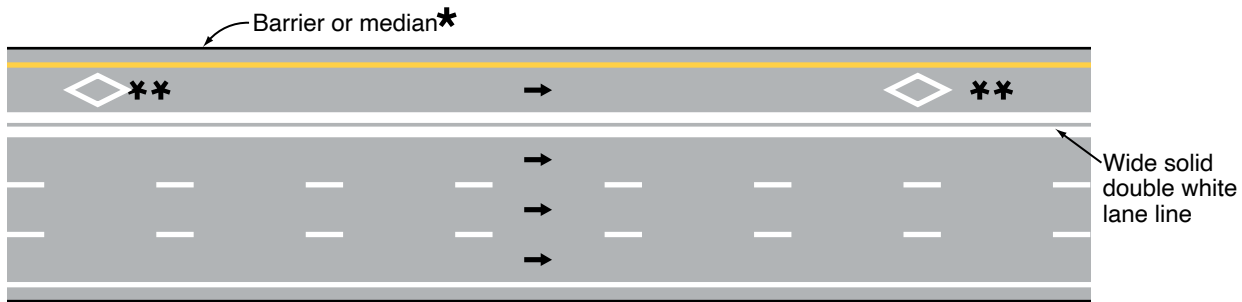
**Table 3E-2. Standard Center Line and Edge Line Markings for Counter-Flow Preferential Lanes on Divided Highways**

| Type of Preferential Lane  | Center Line on Left-Hand Side   | Edge Line on Left-Hand Side                     |
|----------------------------|---|---|
| Part-Time Contiguous       | A normal width broken double yellow line                                      | A normal solid single white line (if warranted) |
| Part-Time Buffer-Separated | A normal width broken double yellow line along both edges of the buffer space | A normal solid single white line (if warranted) |
| Full-Time Contiguous       | A normal width solid double yellow line                                       | A normal solid single white line (if warranted) |
| Full-Time Buffer-Separated | A normal width solid double yellow line along both edges of the buffer space  | A normal solid single white line (if warranted) |

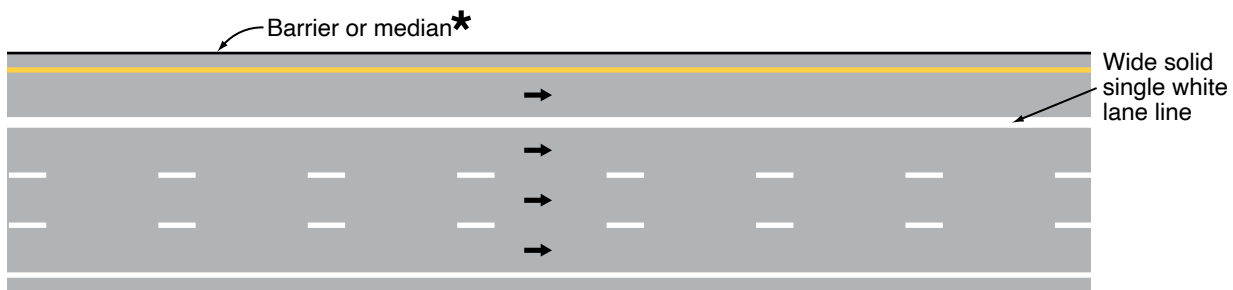
**Figure 3E-3. Markings for Contiguous Preferential Lanes**



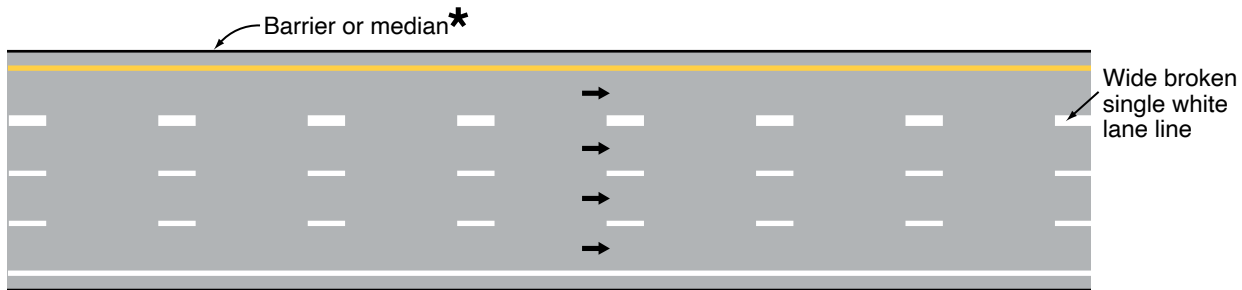
**A – Full-time preferential lane(s) where enter/exit movements are PROHIBITED**



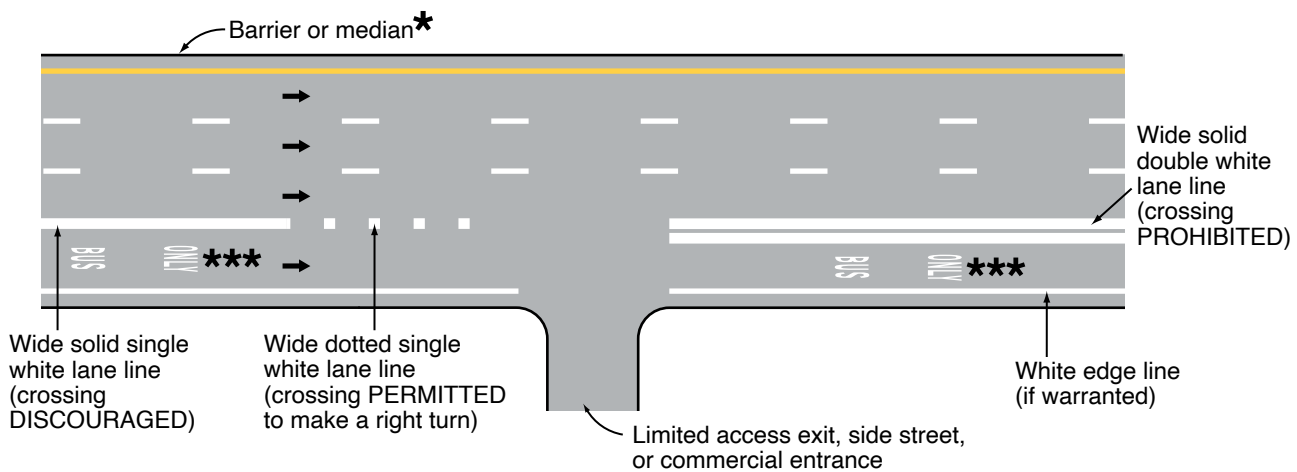
**B – Preferential lane(s) where enter/exit movements are DISCOURAGED**



**C – Preferential lane(s) where enter/exit movements are PERMITTED**



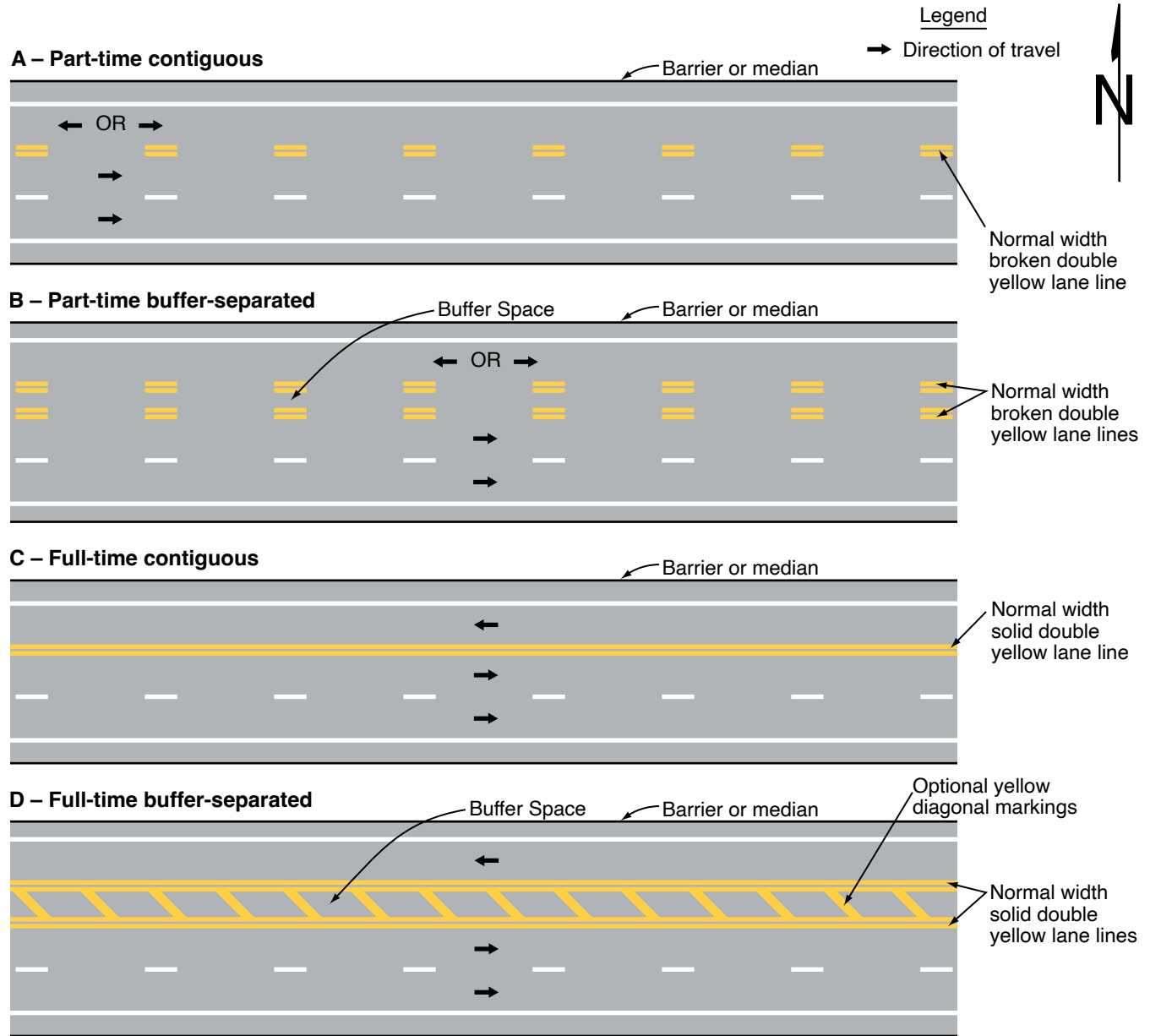
**D – Right-hand side preferential lane(s)**



- \* If no barrier or median is present and the left-hand side of the lane is the center line of a two-way roadway, use a double yellow center line
- \*\* Example of HOV only lane symbol markings. Space at 1/4-mile intervals or as determined by engineering judgment (see Section 3E.03)
- \*\*\* Example of preferential lane word pavement markings

Legend  
 → Direction of travel

**Figure 3E-4. Markings for Contra-Flow Preferential Lanes on Divided Highways**



*Guidance:*

03 *If multiple preferential lane uses are allowed in a single lane, the word or symbol marking for each preferential lane should be used.*

**Standard:**

04 **Pavement word or symbol markings for motorcycles and Inherently Low Emission Vehicles (ILEV) shall not be used to mark the preferential lane if motorcycles and ILEVs are allowed to use the preferential lane.**

**Support:**

05 Motorcycles and Inherently Low Emission Vehicles (ILEV) that are allowed to use a preferential lane are granted an exception such as through an established High-Occupancy Vehicle (HOV) regulation. Communicating that motorcycles and ILEVs are allowed to use the preferential lane is accomplished through regulatory signing (see Sections 2G.03 and 2G.04) that complements HOV signing.

**Standard:**

06 **Static or changeable message regulatory signs (see Sections 2G.03 through 2G.07) shall be used with preferential lane word or symbol markings.**

07 **All preferential lane word and symbol markings shall be white and shall be positioned laterally in the approximate center of the preferential lane.**

Option:

08 Preferential lane-use symbol or word markings may be omitted at toll plazas where physical conditions preclude the use of the markings.

09 Lane-use arrow markings may be placed on the curb lanes on approaches to intersections to signify non-preferential road users can use the lane for turning movements.

Guidance:

10 *All longitudinal pavement markings, as well as word and symbol pavement markings, associated with a preferential lane should end at approximately where the Preferential Lane Ends (R3-12a or R3-12c) sign (see Section 2G.07) designating the downstream end of the preferential only lane restriction is installed.*

11 *The spacing of the markings should be based on engineering judgment that considers the operating speed, block lengths, distance from intersections, and other factors that affect clear communication to the road user.*

12 *In addition to a regular spacing interval, the preferential lane marking should be placed at strategic locations such as major decision points, direct exit ramp departures from the preferential lane, and along access openings to and from adjacent general-purpose lanes. At decision points, the preferential lane marking should be placed on all applicable lanes and should be visible to approaching traffic for all available departures. At direct exits from preferential lanes where extra emphasis is needed, the use of word markings (such as "EXIT" or "EXIT ONLY") in the deceleration lane for the direct exit and/or on the direct exit ramp itself just beyond the exit gore should be considered.*

Option:

13 A numeral indicating the vehicle occupancy requirements established for a high-occupancy vehicle lane may be included in sequence after the diamond symbol or HOV word message.

### **Section 3E.04 Markings for Part-Time Travel on a Shoulder**

Support:

01 Shoulders are sometimes used to add capacity to a roadway in peak hour conditions to provide for transit or HOV priority or to provide higher throughput when open to all traffic.

02 A shoulder that has been opened to travel on a permanent, rather than a part-time basis is considered to be a travel lane and is signed and marked in accordance with other provisions of this Manual.

**Standard:**

03 **When part-time travel on a shoulder is open to all traffic, pavement word and symbol markings shall not be used in the shoulder.**

04 **When a shoulder is assigned part-time to a particular class or classes of vehicles, the shoulder shall be marked with one or more pavement word markings that identify the special use of the shoulder such as BUS ONLY, TRANSIT ONLY, HOV, or instead of the HOV pavement word marking, white lines formed in a diamond-shaped symbol (see Section 3E.03). A pavement word or symbol marking shall be provided in the shoulder immediately after exit and entry ramps (see Figure 3E-5) or immediately departing an intersection at the full-width shoulder (see Figure 3E-6). Appropriate regulatory signing (see Section 2G.03) shall be installed with the pavement word or symbol markings.**

05 **The channelizing line emanating from the entrance ramp shall be a wide dotted line through the intersecting alignment of the shoulder to the theoretical gore (see Drawings A and B in Figure 3E-5). At exit ramps, the channelizing line proceeding from the theoretical gore across the intersecting alignment of the shoulder shall be a wide dotted line (see Figure 3E-5).**

06 **If used, the extension of the channelizing line at entrance ramps proceeding from the theoretical gore across the opening of the on-ramp alignment shall be a wide dotted line (see Drawing C in Figure 3E-5) where it is demonstrated that traffic entering from an on-ramp stops or yields to traffic on the shoulder of the highway mainline.**

07 **An additional outside solid edge line shall be provided on the shoulder in accordance with Sections 3B.09 and 3B.10.**

Guidance:

08 *Changes in edge line pattern or direction should occur at appropriate regulatory signs.*

Option:

09 At locations where traffic is allowed to enter, exit, or merge with the shoulder, a dotted edge line may be used either in a continuous manner or angled to the pavement edge (see Figure 3E-6).

10 Red-colored pavement (see Section 3H.07) may be used on shoulders that allow only transit vehicles.

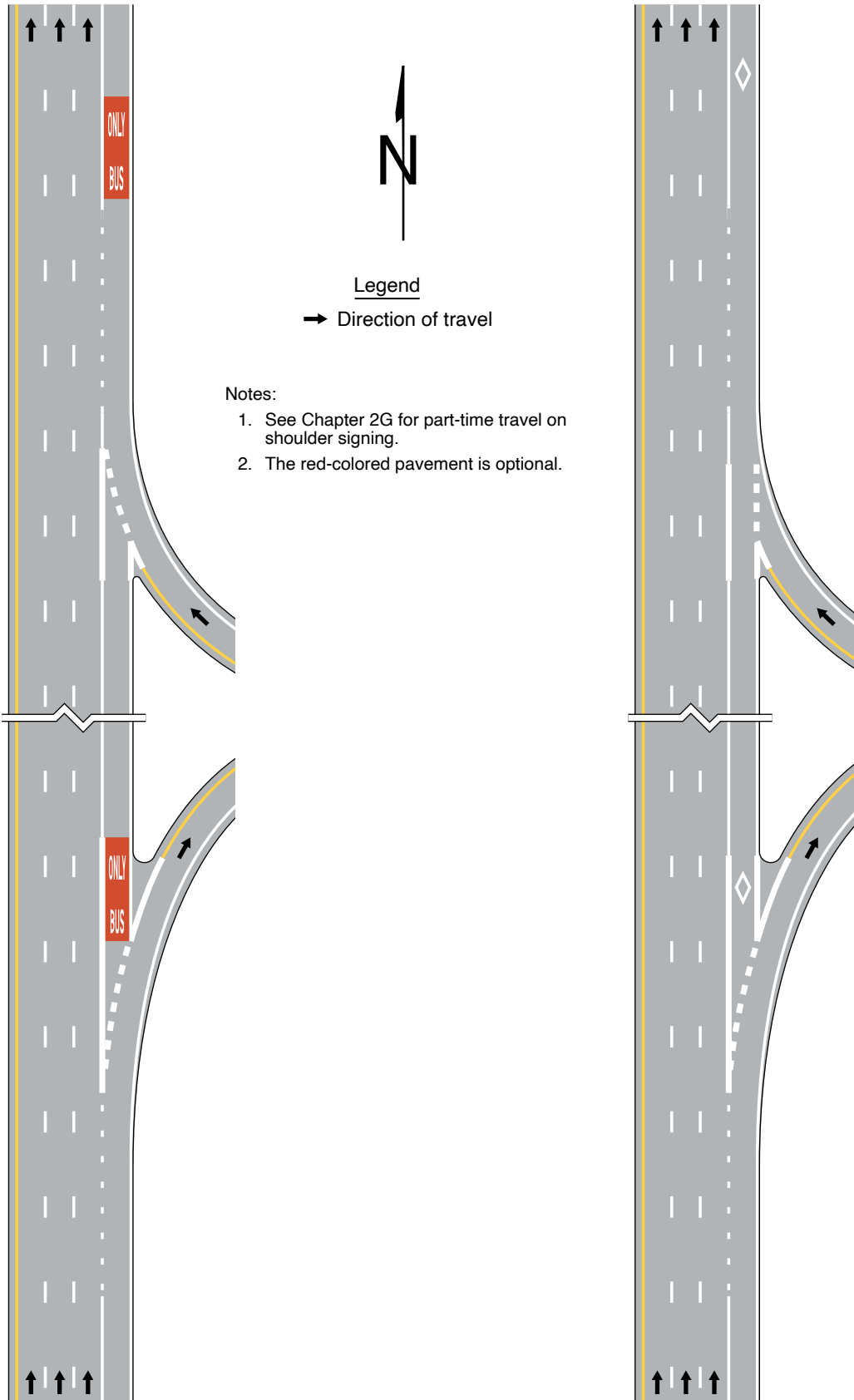
**Standard:**

11 **If used, red-colored pavement shall be discontinued on the shoulder through the influence area of the ramp (see Figure 3E-5).**

**Figure 3E-5. Markings for Part-Time Travel on Shoulder and Application of Pavement Word Markings (Sheet 1 of 3)**

**A – Right-hand shoulder - transit use only**

**B – Right-hand shoulder - HOV allowed**

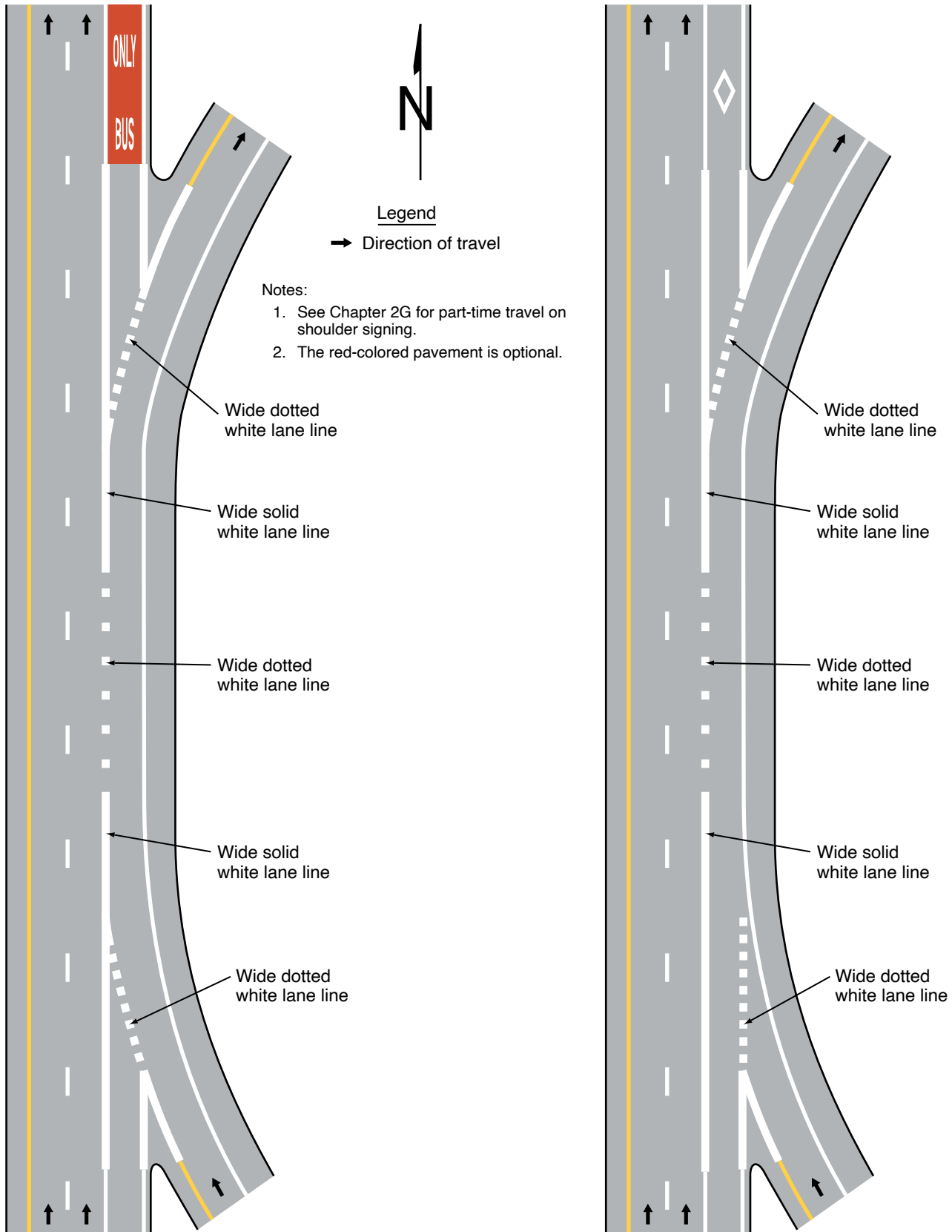




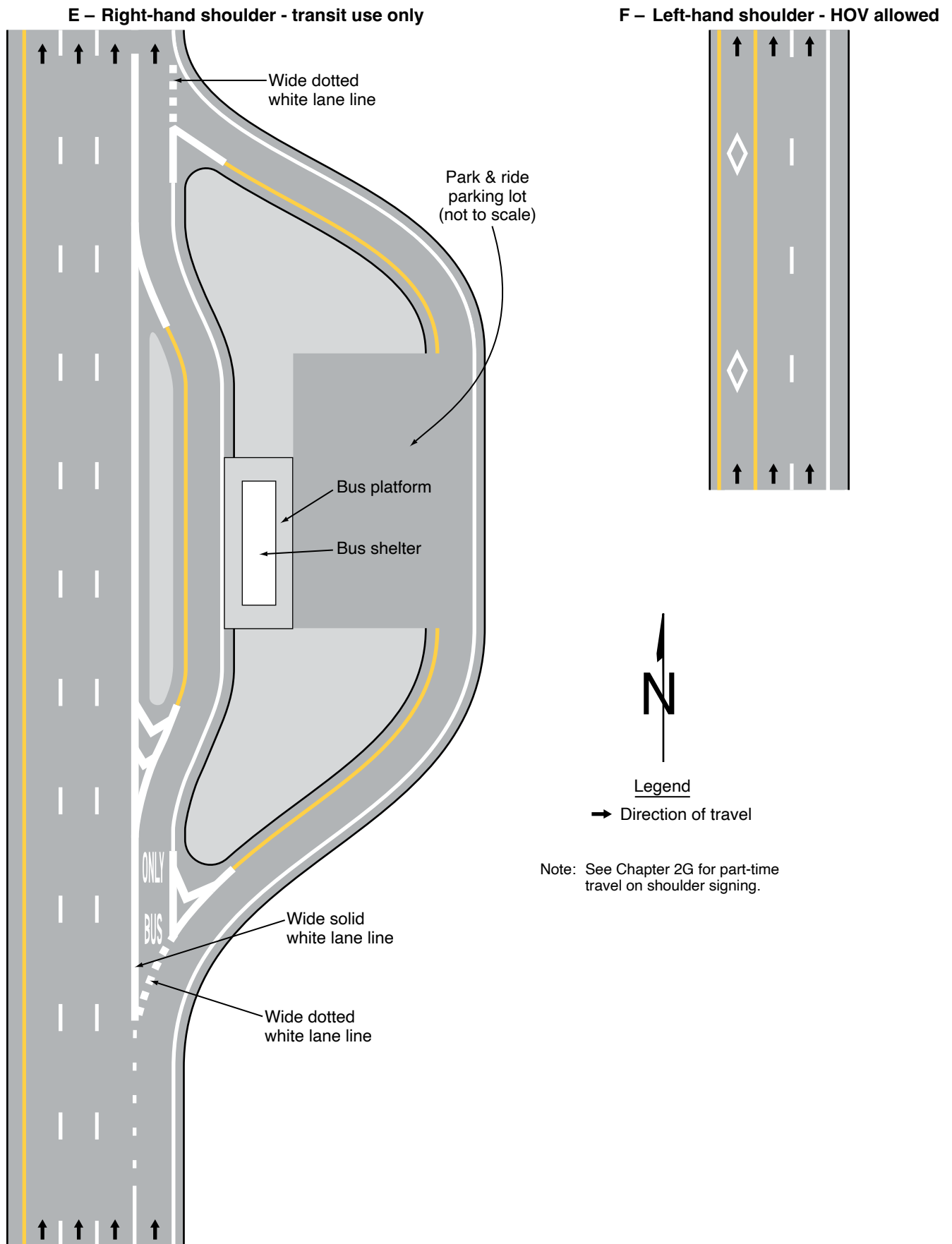
**Figure 3E-5. Markings for Part-Time Travel on Shoulder and Application of Pavement Word Markings (Sheet 2 of 3)**

**C – Right-hand shoulder - transit use only**

**D – Right-hand shoulder - HOV allowed**



**Figure 3E-5. Markings for Part-Time Travel on Shoulder and Application of Pavement Word Markings (Sheet 3 of 3)**





## CHAPTER 3F. MARKINGS FOR TOLL PLAZAS

### Section 3F.01 General

Support:

- 01 At toll plazas, pavement markings help road users identify the proper lane(s) to use for the type of toll payment they plan to use, to channelize movements into the various lanes, and to delineate obstructions in the roadway.
- 02 Section 3H.08 contains information on the use and application of purple-colored pavement at toll plazas for vehicles with registered electronic toll collection (ETC) accounts.

### Section 3F.02 Longitudinal Markings

Guidance:

- 01 *Solid white lane line markings should be used to separate toll lanes, payment methods, or to channelize movements at toll plazas.*
- 02 *Solid white lane line markings should begin at the upstream end of the full-width toll lane and be continued to the toll plaza.*

Option:

- 03 For a toll plaza approach lane that is restricted to use only by vehicles with registered ETC accounts, the solid white lane line or edge line on the right-hand side of the ETC Account-Only lane and the solid white lane line or solid yellow edge line on the left-hand side of the ETC Account-Only lane may be supplemented with purple solid longitudinal markings placed contiguous to the inside edges of the lines defining the lane.

**Standard:**

- 04 **If the purple solid longitudinal markings described in Paragraph 3 of this Section are used, the purple markings shall be at least 3 inches wide.**

Guidance:

- 05 *If the purple solid longitudinal markings described in Paragraph 3 of this Section are used, the purple markings should not be wider than the line they supplement.*

**Standard:**

- 06 **Toll booths and the islands on which they are located are considered to be obstructions in the roadway and they shall be provided with markings that comply with the provisions of Section 3B.13 and Chapter 3J.**

Option:

- 07 Longitudinal pavement markings may be omitted alongside toll booth islands between the approach markings and any departure markings.

### Section 3F.03 Pavement Word and Symbol Markings

Support:

- 01 Section 3E.03 contains information on the use of pavement word and symbol markings for ETC Account-Only lanes not specific to toll plazas.

**Standard:**

- 02 **Except as provided in Paragraph 4 of this Section, when a lane on the approach to a toll plaza is restricted to use only by vehicles with registered ETC accounts, the ETC Account-Only lane word markings or pictograph described in Section 3E.03 shall be used (see Drawing A in Figure 3H-6).**

- 03 **When one or more open-road tolling (ORT) lanes that are restricted to use only by vehicles with registered ETC accounts bypass a mainline toll plaza on a separate alignment, pavement word markings or pictographs shall be used on the approach to the point where the ORT lanes diverge from the lanes destined for the mainline toll plaza (see Drawings B and C in Figure 3H-6).**

Option:

- 04 Preferential lane-use markings may be omitted at toll plazas where physical conditions preclude the use of the markings.

Guidance:

- 05 *If an ORT lane that is immediately adjacent to a mainline toll plaza is not separated from adjacent cash payment toll plaza lanes by a curb or barrier, then channelizing devices (see Section 3I.01), and/or longitudinal pavement markings that discourage or prohibit lane changing should be used to separate the ORT lane from the adjacent cash payment lane. This separation should begin on the approach to the mainline toll plaza at approximately the point where the vehicle speeds in the adjacent cash lanes drop below 30 mph during off-peak periods and should extend downstream beyond the toll plaza approximately to the point where the vehicles departing the toll plaza in the adjacent cash lanes have accelerated to 30 mph.*

## CHAPTER 3G. DELINEATORS

### Section 3G.01 General

Support:

- 01 Delineators are particularly beneficial at locations where the alignment might be confusing or unexpected, such as at lane-reduction transitions and curves. Delineators are effective guidance devices at night and during adverse weather. An important advantage of delineators in certain locations is that they remain visible when the roadway is wet or covered by snow.
- 02 Delineators are considered guidance devices to help road users navigate the roadway alignment, rather than warning devices.

Option:

- 03 Delineators may be used on long continuous sections of highway or through short stretches where there are changes in horizontal alignment.

### Section 3G.02 Design

Standard:

- 01 **Delineators shall consist of retroreflective devices that are capable of clearly retroreflecting light under normal atmospheric conditions from a distance of 1,000 feet when illuminated by the high beams of standard automobile lights. They shall be mounted on crashworthy (see definition in Section 1C.02) supports.**
- 02 **Retroreflective elements for delineators shall have a minimum vertical and horizontal dimension of 3 inches, or a minimum diameter dimension of 3 inches when circular.**

Support:

- 03 Within a series of delineators along a roadway, delineators for a given direction of travel at a specific location are referred to as single delineators if they have one retroreflective element for that direction, double delineators if they have two identical retroreflective elements for that direction mounted together, or vertically-elongated delineators if they have a single retroreflective element with an elongated vertical dimension to approximate the vertical dimension of two separate single delineators.

Option:

- 04 A vertically-elongated delineator of appropriate size may be used in place of a double delineator.

### Section 3G.03 Application

Standard:

- 01 **The color of delineators shall comply with the color of edge lines stipulated in Sections 3A.03 and 3B.09.**
- 02 **A series of single delineators shall be provided on the right-hand side of freeways and expressways and on at least one side of interchange ramps, except when either Condition A or Condition B is met, as follows:**
- A. On tangent sections of freeways and expressways when both of the following conditions are met:**
1. **Raised pavement markers are used continuously on lane lines throughout all curves and on all tangents to supplement pavement markings, and**
  2. **Roadside delineators are used to lead into all curves, or**
- B. On sections of roadways where continuous lighting is in operation between interchanges.**

Option:

- 03 Delineators may be provided on other classes of roads.
- 04 A series of single delineators may be provided on the left-hand side of roadways.
- 05 Chevron Alignment (W1-8) signs may be used instead of or in addition to standard delineators, as provided in Section 2C.08.

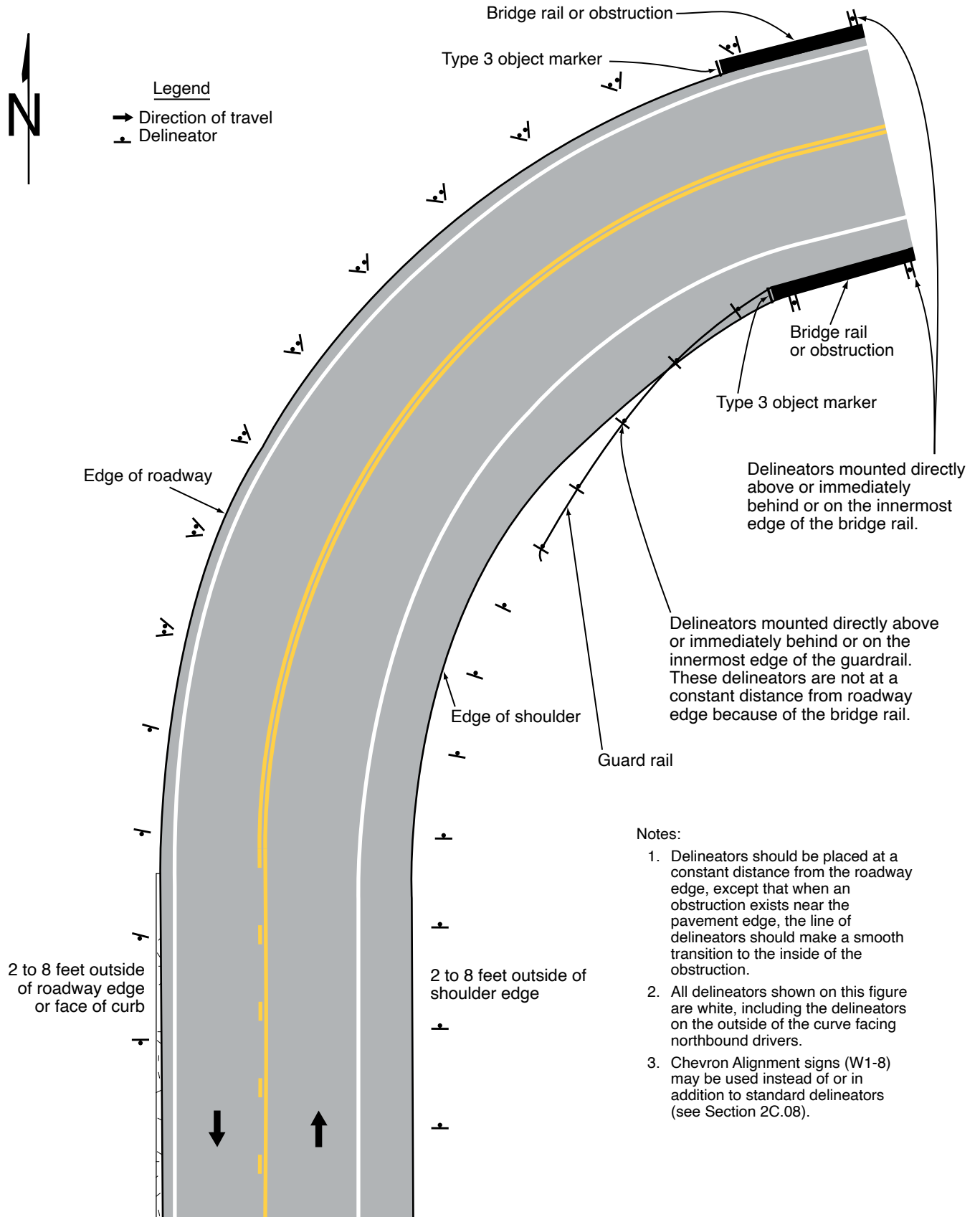
Standard:

- 06 **Delineators on the left-hand side of a two-way roadway shall be white (see Figure 3G-1).**

Guidance:

- 07 *A series of single delineators should be provided on the outside of curves on interchange ramps.*
- 08 *Where median crossovers are provided for official or emergency use on divided highways and where these crossovers are to be marked with pavement markings, a double yellow delineator should be placed on the left-hand side of the through roadway on the far side of the crossover for each roadway.*

Figure 3G-1. Examples of Delineator Placement



09 *Double or vertically-elongated delineators should be installed at approximately 100-foot intervals along acceleration and deceleration lanes.*

10 *A series of delineators should be used wherever guardrail or other longitudinal barriers are present along a roadway or ramp.*

Option:

11 *Red delineators may be used on the reverse side of any delineator where it would be viewed by a road user traveling in the wrong direction on that particular ramp or roadway.*

Guidance:

12 *Except as provided in Paragraph 13 of Section 3B.12, delineators of the appropriate color should be used to indicate a lane-reduction transition where either an outside or inside lane merges into an adjacent lane.*

13 *When used for lane-reduction transitions, the delineators should be installed adjacent to the lane or lanes reduced for the full length of the transition and should be so placed and spaced to show the reduction (see Section 3B.12 and Figure 3B-14).*

14 *On a highway with continuous delineation on either or both sides, delineators should be carried through transitions.*

**Standard:**

15 **When used on a truck escape ramp, delineators shall be red.**

Guidance:

16 *Red delineators should be placed on both sides of truck escape ramps.*

### **Section 3G.04 Placement and Spacing**

Guidance:

01 *Except as provided in Paragraph 2 of this Section, delineators should be mounted at a height, measured vertically from the bottom of the lowest retroreflective device to the elevation of the near edge of the roadway, of approximately 4 feet.*

Option:

02 *When mounted on the face of or on top of guardrails or other longitudinal barriers, delineators may be mounted at a lower elevation than the normal delineator height recommended in Paragraph 1 of this Section.*

Guidance:

03 *Delineators should be placed 2 to 8 feet outside the outer edge of the shoulder, or if appropriate, in line with the roadside barrier that is 8 feet or less outside the outer edge of the shoulder.*

04 *Delineators should be placed at a constant distance from the edge of the roadway, except that where an obstruction intrudes into the space between the pavement edge and the extension of the line of the delineators, the delineators should be transitioned to be in line with or inside the innermost edge of the obstruction. If the obstruction is a guardrail or other longitudinal barrier, the delineators should be transitioned to be just behind, directly above (in line with), or on the innermost edge of the guardrail or longitudinal barrier.*

05 *Delineators should not present a vertical or horizontal clearance obstacle for pedestrians.*

06 *Delineators should be spaced 200 to 530 feet apart on mainline tangent sections. Delineators should be spaced 100 feet apart on ramp tangent sections.*

Option:

07 *On a highway with continuous delineation on either or both sides, the spacing between a series of delineators may be closer.*

08 *When uniform spacing is interrupted by such features as driveways and intersections, delineators which would ordinarily be located within the features may be relocated in either direction for a distance not exceeding ¼ of the uniform spacing. Delineators still falling within such features may be eliminated.*

09 *Delineators may be transitioned in advance of a lane transition or obstruction as a guide for oncoming traffic.*

Guidance:

10 *The spacing of delineators should be adjusted on approaches to and throughout horizontal curves so that several delineators are always simultaneously visible to the road user. The approximate spacing shown in Table 3G-1 should be used.*

11 *The spacing between red delineators that are placed on both sides of a truck escape ramp should not exceed 50 feet for a distance that is sufficient to identify the ramp entrance. The spacing between red delineators that are placed beyond the ramp entrance should be such that adequate guidance is provided based on the length and design of the escape ramp.*

Option:

- 12 When needed for special conditions, delineators of the appropriate color may be mounted in a closely-spaced manner on the face of or on top of guardrails or other longitudinal barriers to form a continuous or nearly-continuous “ribbon” of delineation.

Support:

- 13 Examples of delineator installations are shown in Figure 3G-1.

**Table 3G-1. Approximate Spacing for Delineators on Horizontal Curves**

| Radius (R) of Curve | Approximate Spacing (S) on Curve |
|---------------------|----------------------------------|
| 50 feet             | 20 feet                          |
| 115 feet            | 25 feet                          |
| 180 feet            | 35 feet                          |
| 250 feet            | 40 feet                          |
| 300 feet            | 50 feet                          |
| 400 feet            | 55 feet                          |
| 500 feet            | 65 feet                          |
| 600 feet            | 70 feet                          |
| 700 feet            | 75 feet                          |
| 800 feet            | 80 feet                          |
| 900 feet            | 85 feet                          |
| 1,000 feet          | 90 feet                          |

- Notes:
1. Spacing for specific radii may be interpolated from table.
  2. The minimum spacing should be 20 feet.
  3. The spacing on curves should not exceed 300 feet.
  4. In advance of or beyond a curve, and proceeding away from the end of the curve, the spacing of the first delineator is 2S, the second 3S, and the third 6S, but not to exceed 300 feet.
  5. S refers to the delineator spacing for specific radii computed from the formula  $S=3\sqrt{R-50}$ .
  6. The distances for S shown in the table above were rounded to the nearest 5 feet.



## CHAPTER 3H. COLORED PAVEMENT

### Section 3H.01 Standardization of Application

Support:

- 01 Colored pavements consist of differently-colored road paving materials, such as colored asphalt or concrete. Other surface treatments can be applied to the surface of a road, island, or area outside the traveled way to simulate a colored pavement.
- 02 If non-retroreflective colored pavement is used as a purely aesthetic surface treatment (see Section 3H.03) within the provisions of this Chapter and are not intended to communicate regulations, warnings, guidance, or other information to road users, the colored pavement is not considered to be a traffic control device, even if it is located between the lines of a crosswalk.

**Standard:**

- 03 **If colored pavement is used within the traveled way, on flush or raised islands, or on shoulders to communicate regulations, warnings, guidance, or other information to road users, or if retroreflectivity is used, the colored pavement shall be considered a traffic control device and shall be limited to the colors and applications specified in this Chapter.**
- 04 **Except as provided in Paragraph 5 of Section 3H.07, colored pavement shall only be used if the corresponding regulations, warnings, or guidance are applicable at all times.**

*Guidance:*

- 05 *Colored pavements used as traffic control devices should only be used where the color pavement contrasts significantly with adjoining paved areas.*

Support:

- 06 The chromaticity coordinates that define the ranges of acceptable colors for traffic control devices are found in the Appendix to Subpart F of 23 CFR 655.

**Standard:**

- 07 **If used, colored pavement shall only be used to supplement other markings as provided in this Manual.**

Support:

- 08 Longitudinal pavement markings, crosswalks, pavement marking symbols, and elongated route markers are not considered colored pavements.

### Section 3H.02 Materials

Option:

- 01 Colored pavements may be either retroreflective or non-retroreflective, in accordance with the provisions of this Chapter for specific applications.

*Guidance:*

- 02 *If surface treatments are applied to the surface of a road, island, or other area outside the traveled way to simulate a colored pavement, pavement marking materials should be selected that will minimize loss of traction for road users (see Paragraph 2 of Section 3A.02).*

Support:

- 03 Providing for retroreflectivity, such as incorporating glass beads, can affect the skid resistance of pavement markings.
- 04 Installation of colored pavement to one lane or an area or portion of a multi-lane traveled way can create differentials in skid resistance values between the areas of colored pavement and non-colored pavement that might be unexpected by the road user.

### Section 3H.03 Aesthetic Surface Treatments

Support:

- 01 Aesthetic surface treatments are sometimes used between the transverse lines within a crosswalk, in islands, in medians, in shoulders, within sidewalk extensions designated by pavement markings, or in other areas outside of the traveled way.
- 02 Common examples of materials used as aesthetic surface treatments include brick, paving bricks, paving stones, or other materials designed to simulate such paving. Some examples of geometries for aesthetic surface treatments include honeycomb, lattice, mesh, grid, and regular polygon patterns.
- 03 Surfaces with individual units laid out of plane and those that are heavily-textured, rough, or chamfered, could increase rolling resistance and subject pedestrians who use wheelchairs to the effects of vibration; it is desirable to minimize surface discontinuities.

04 Common examples of colors for aesthetic surface treatments incorporated into the material or geometry are brick red, rust, brown, burgundy, clay, tan, or similar earth-tone equivalents (see Figure 3H-1).

**Standard:**

- 05 **Aesthetic surface treatments shall not interfere with traffic control devices.**
- 06 **Aesthetic surface treatments shall not be of a surface that can confuse pedestrians with vision disabilities that rely on tactile treatments or cues for navigation.**
- 07 **Colors used for aesthetic surface treatments shall be outside the chromaticity coordinates that define the ranges of acceptable colors for traffic control devices.**
- 08 **Patterns that constitute a purely aesthetic surface treatment shall be devoid of advertising and shall not contain elements of retroreflectivity.**
- 09 **Patterns that constitute a purely aesthetic surface treatment for the interior area of a crosswalk shall not be designed to encourage road users to remain in the crosswalk, engage or interact with the pattern, or otherwise inhibit users from crossing the street in a safe and efficient manner.**

*Guidance:*

- 10 *Aesthetic surface treatments should not use colors or patterns that degrade the contrast of markings used to delineate an area, or that might be mistaken by road users as a traffic control application.*
- 11 *To provide contrast, a gap of at least one-half the width of the white transverse line used to establish the crosswalk, but not less than 6 inches, should be used between the white crosswalk lines and the aesthetic surface treatment, such as unmarked pavement or a black contrast line (see Section 3A.03).*
- 12 *To provide contrast, a gap of at least the width of the longitudinal line used to establish the area should be used between the longitudinal line and the aesthetic surface treatment, such as unmarked pavement or a black contrast line (see Section 3A.03). If the longitudinal line is a double line, the gap should be at least the width of one of the lines that makes up the double line.*
- 13 *Aesthetic surface treatments should not contain pictographs, illustrations, or symbols.*

**Section 3H.04 Yellow-Colored Pavement**

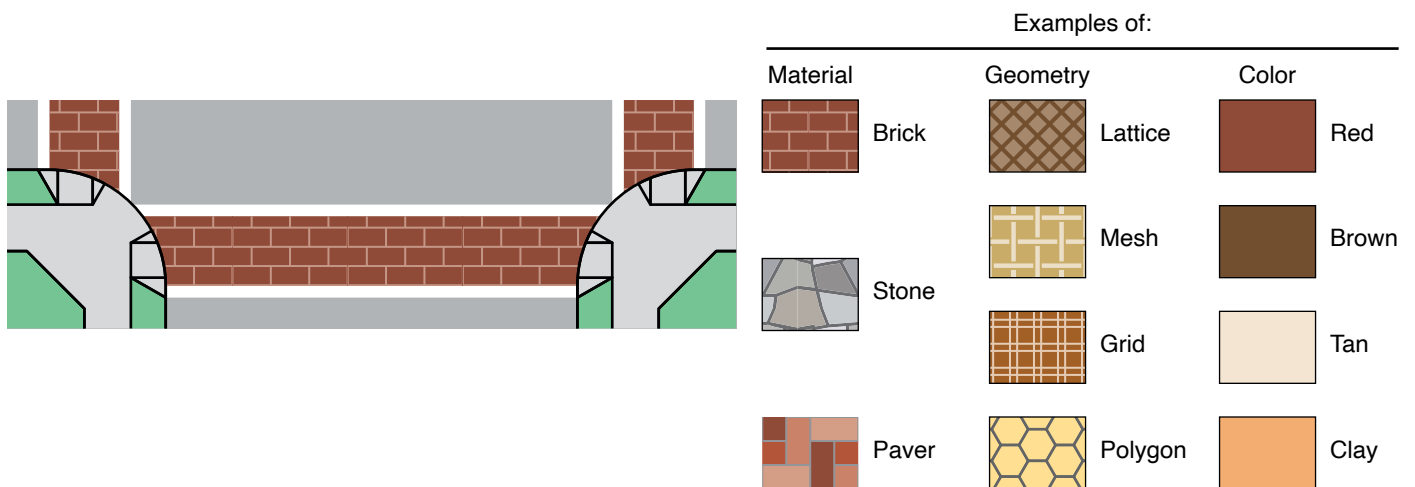
**Support:**

01 Yellow-colored pavement is used to enhance the conspicuity of areas separating traffic traveling in opposite directions of travel and the left-hand edge of the roadway.

**Standard:**

- 02 **If used, yellow-colored pavement shall be limited to:**
  - A. **Flush or raised median islands separating traffic flows in opposite directions,**
  - B. **Left-hand shoulders of divided highways, and**
  - C. **Left-hand shoulders of one-way streets or ramps.**
- 03 **Yellow-colored pavement shall not be incorporated into elements of the roadway that function as reversible lanes or two-way left-turn lanes.**
- 04 **Yellow-colored pavement shall not be used on channelizing islands where traffic travels in the same general direction on both sides.**

**Figure 3H-1. Aesthetic Treatments for Transverse Crosswalks**



Option:

- 05 Yellow-colored pavement may be installed for the entire length of the roadway, island, or shoulder, or for only a portion or portions of the roadway, island, or shoulder.

Support:

- 06 An example of an application of yellow-colored pavement is shown in Figure 3H-2.

**Section 3H.05 White-Colored Pavement**

Support:

- 01 White-colored pavement is used to enhance the conspicuity of areas separating traffic traveling in the same direction of travel and the right-hand edge of the roadway.

**Standard:**

- 02 **If used, white-colored pavement shall be limited to:**
  - A. Flush or raised channelizing islands where traffic passes on both sides in the same general direction,**
  - B. Right-hand shoulders,**
  - C. Exit gore areas, and**
  - D. Entrance gore areas.**

Guidance:

- 03 *When used on right-hand shoulders, white-colored pavement should be limited to areas not intended for use by motor vehicle traffic except those shoulders designated for emergency use.*

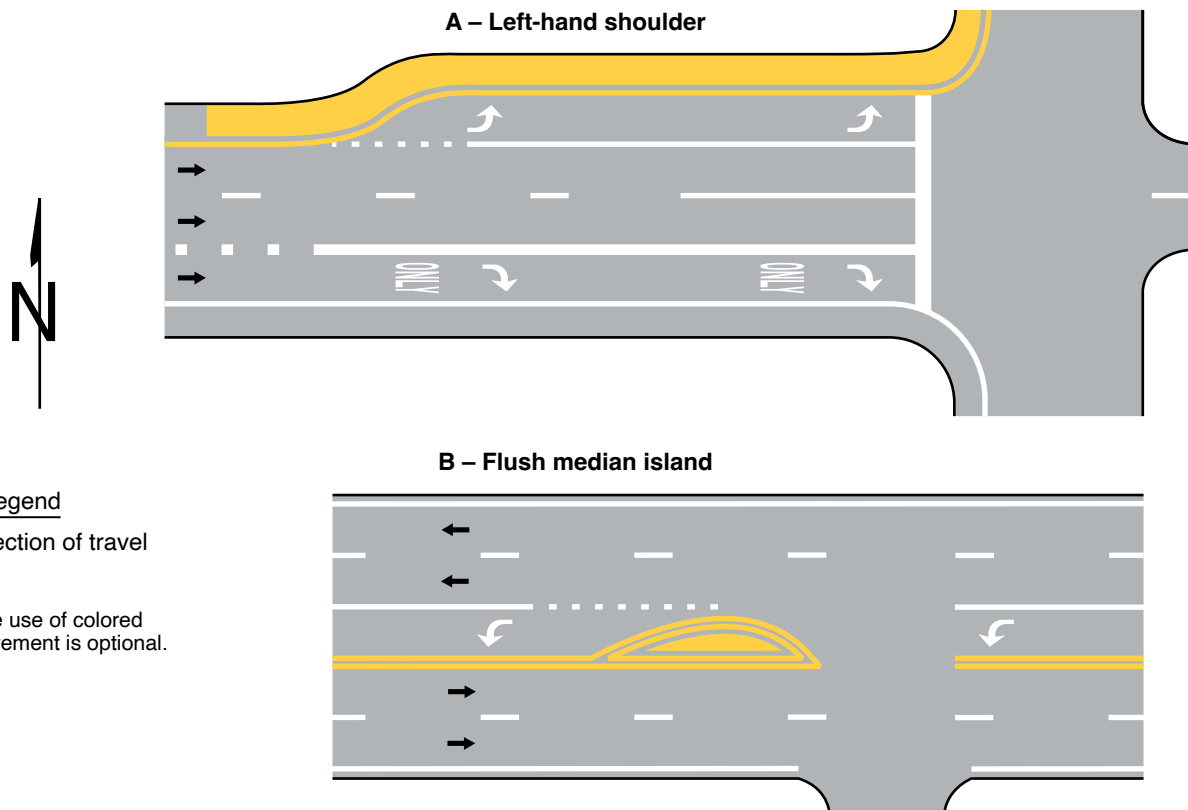
Option:

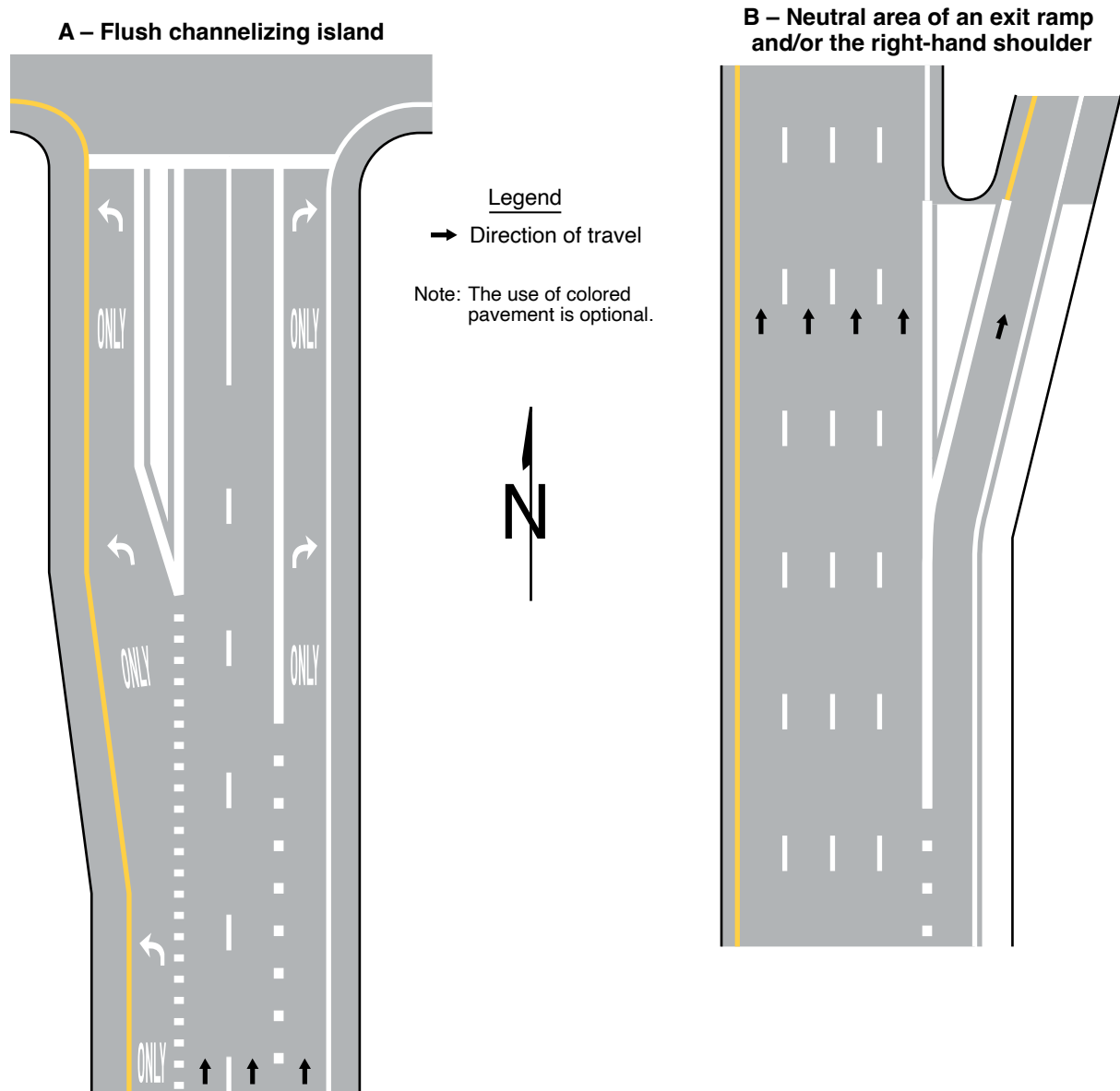
- 04 White-colored pavement may be installed for the entire length of the roadway, island, or shoulder, or for only a portion or portions of the roadway, island, or shoulder.
- 05 White-colored pavement may be used instead of chevron markings (see Sections 3B.13 and 3B.25) in neutral areas.

Support:

- 06 An example of an application of white-colored pavement is shown in Figure 3H-3.

**Figure 3H-2. Examples of Yellow-Colored Pavement Applications**



**Figure 3H-3. Examples of White-Colored Pavement Applications****Section 3H.06 Green-Colored Pavement for Bicycle Facilities**

Support:

- 01 Green-colored pavement is used to enhance the conspicuity of locations where bicyclists are expected to operate, and areas where bicyclists and other traffic might have potentially conflicting, weaving, or crossing movements. Green-colored pavement is also used to enhance the conspicuity of word, symbol, and/or arrow pavement markings when these markings are used in certain bicycle facilities.

**Standard:**

- 02 **If used, green-colored pavement shall be limited to:**
- A. Bicycle lanes (see Sections 9E.01, 9E.06, 9E.07, and 9E.08),**
  - B. Extensions of bicycle lanes through intersections (see Section 9E.03),**
  - C. Extensions of bicycle lanes through areas where motor vehicles enter a mandatory turn lane in which motor vehicles must weave across bicyclists in bicycle lanes (see Section 9E.02),**
  - D. Two-stage bicycle turn boxes (see Section 9E.11),**
  - E. Bicycle Boxes (see Section 9E.12), and**
  - F. As a background for bicycle detector symbols (see Section 9E.15).**

03 **Green-colored pavement shall not be:**

- A. Incorporated into electric-vehicle parking stations or parking stalls,
- B. Incorporated into crosswalks (see Chapter 3C),
- C. Used as a background for shared-lane markings (see Section 9E.09), or
- D. Used instead of the required markings for bicycle facilities (see Chapter 9E).

04 **If used, the pattern of the green-colored pavement supplementing dotted extension lines shall match the pattern of the dotted lines, thus filling in only the areas that are directly between a pair of dotted line segments. If used, the pattern of the green-colored pavement supplementing a dotted longitudinal line, which defines a bicycle lane (see Paragraph 11 of Section 9E.02), shall match the pattern of the dotted line, thus filling in only the areas that are directly between a line segment and the curb, or, in the absence of a curb, the edge of the roadway.**

*Guidance:*

05 *If green-colored pavement is used within separated bicycle lanes on an independent alignment, it should be used only at the entrances to those facilities from roadways open to public travel or at conflict, weaving, or crossing locations.*

06 *If green-colored pavement is used within shared-use paths, it should be used only where pedestrian and bicyclist movements are separated and for only a portion (or portions) of the path designated for bicyclist use.*

*Option:*

07 Green-colored pavement may be installed for the entire length of a bicycle lane or bicycle lane extension or for only a portion (or portions) of the bicycle lane or bicycle lane extension.

08 Green-colored pavement may be installed for the entire length of a physically-separated bikeway within the roadway or for only a portion (or portions) of the physically-separated bikeway within the roadway.

*Guidance:*

09 *Appropriate regulatory (see Chapter 9B) or guide signing (see Chapter 9D) should be installed to provide related information to the presence of the colored pavement.*

*Support:*

10 Examples of applications of green-colored pavement are shown in Figure 3H-4.

### **Section 3H.07 Red-Colored Pavement for Public Transit Systems**

*Support:*

01 Red-colored pavement is used to enhance the conspicuity of locations, station stops, or travel lanes in the roadway exclusively reserved for vehicles of public transit systems or multi-modal facilities where public transit is the primary mode. These public transit vehicles include buses, streetcars, trolleys, light-rail trains, and rapid transit fleets.

*Option:*

02 Red-colored pavement may be used where engineering judgment determines that one or more of the following conditions are expected to result from its application:

- A. Increased travel speeds will be expected by the public transport vehicle after an exclusive lane or facility is provided,
- B. Reduced overall service time through the corridor will be expected by the public transport vehicle,
- C. Decreased rates of illegal parking or occupation of the transit or multi-mode lane or facility will be expected.

**Standard:**

03 **If used, red-colored pavement shall be applied only in lanes, areas, or locations where general-purpose traffic is not allowed to use, queue, wait, idle, or otherwise occupy the lane, area, or location where red-colored pavement is used.**

04 **Red-colored pavement shall be installed for the full width of the lane.**

*Option:*

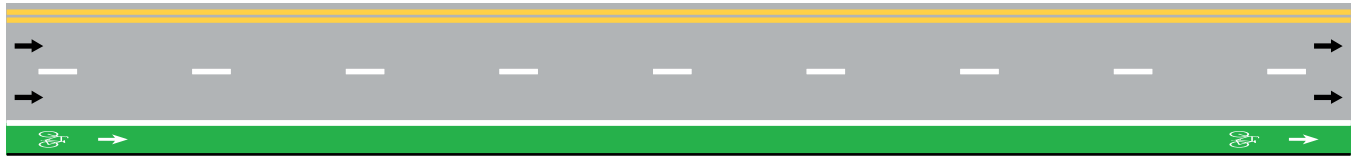
05 Red-colored pavement may be used for full-time or part-time operations.

06 Red-colored pavement may be installed for the entire length of a restricted lane or for only a portion (or portions) of the restricted lane.

07 Red-colored pavement may be installed in a broken pattern where entrance into the transit lane is permitted by general traffic, for example where general traffic is allowed in a transit lane in advance of a turn.

### Figure 3H-4. Examples of Green-Colored Pavement Applications

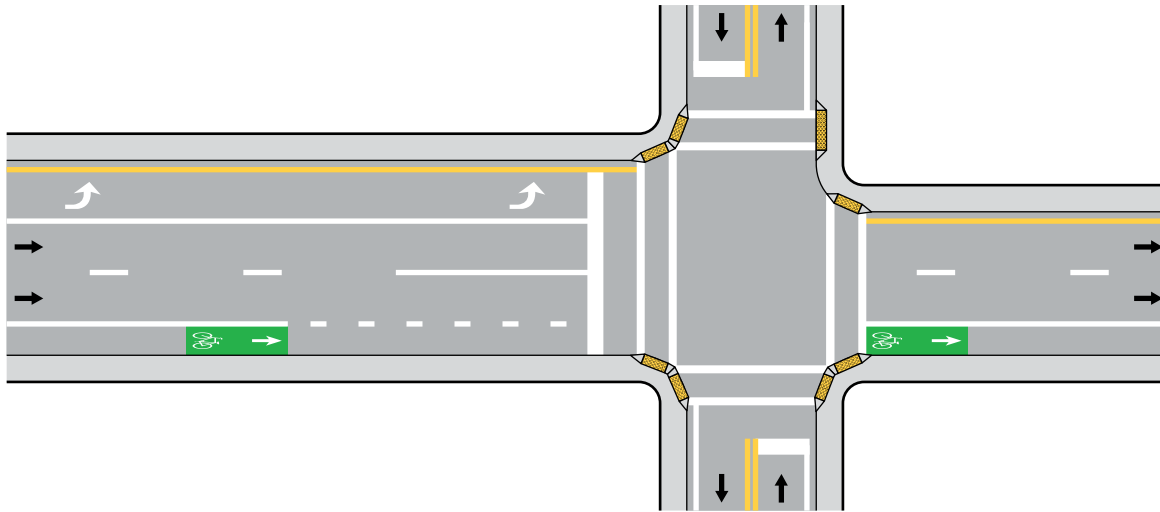
A – Applied to the entire corridor



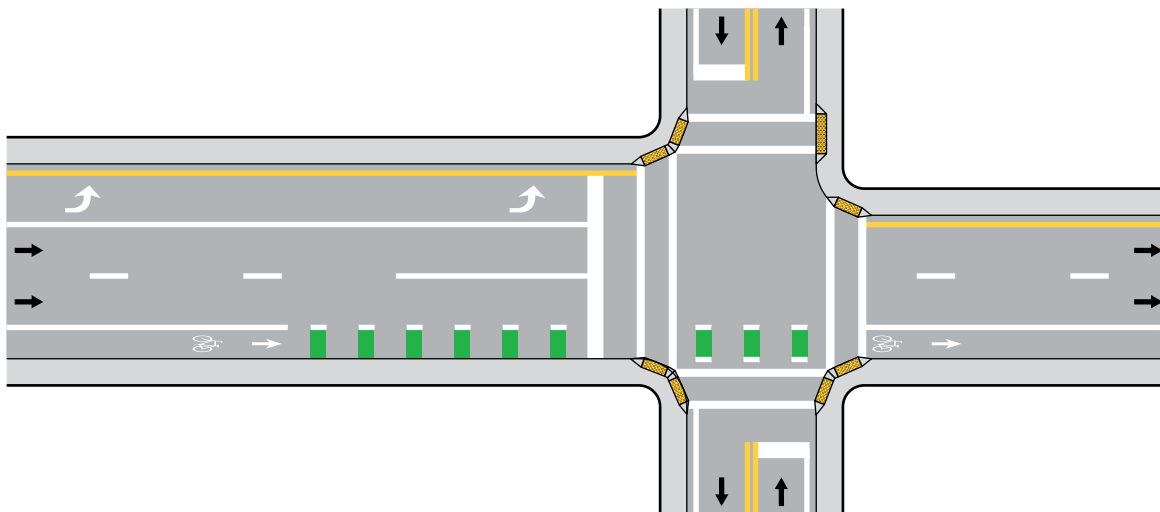
B – Limited to the bicycle symbol and arrow



C – Applied approaching and departing an intersection



D – Applied supplementing the dotted line approaching intersections and/or the dotted extensions of bicycle lanes through intersections



Notes:

- 1. The use of colored pavement is optional.
- 2. See Chapter 9E for bicycle facility markings.

**Legend**  
 → Direction of travel



**Standard:**

- 08 **Regulatory signs (see Sections 2B.02 and 2G.03) shall be used to establish the allowable use of the lane, area, or location. Regulatory signs shall also be used when it is determined that other vehicles will be allowed to enter the lane to turn or bypass queues.**

*Guidance:*

- 09 *If red-colored pavement is used on public transit facilities separated from the roadway or on facilities on an independent alignment, it should be used only at the entrances to those facilities from roadways open to public travel.*

*Support:*

- 10 Examples of applications of red-colored pavement are shown in Figure 3H-5.

### **Section 3H.08 Purple-Colored Pavement for Electronic Toll Collection (ETC) Account-Only Preferential Lanes**

**Standard:**

- 01 **Purple-colored pavement shall be limited to:**

- A. **Lanes on the approach to a toll plaza where the lane is restricted to use only with a registered ETC account; and**
- B. **Lanes or approaches to an open-road tolling (ORT) collection facility that bypasses the physical toll plaza, where the ORT facility is restricted for use only by vehicles with registered ETC accounts.**

- 02 **Purple-colored pavement shall not be used in an approach lane that also facilitates additional payment methods downstream.**

- 03 **If used approaching a physical toll plaza, purple-colored pavement shall be flanked by white solid longitudinal lines that establish the toll lane.**

- 04 **If used on an ORT collection facility that bypasses the physical toll plaza, purple-colored pavement shall be flanked by appropriate edge lines, and if applicable in multi-lane bypasses, appropriate longitudinal solid or broken white lane lines.**

*Option:*

- 05 Purple-colored pavement may be installed for the entire length of a toll lane or ORT collection facility or for only a portion (or portions) of the toll lane or ORT collection facility.

*Support:*

- 06 Figure 3H-6 illustrates examples of purple-colored pavement for use at toll plazas.

**Figure 3H-5. Examples of Red-Colored Pavement Applications**

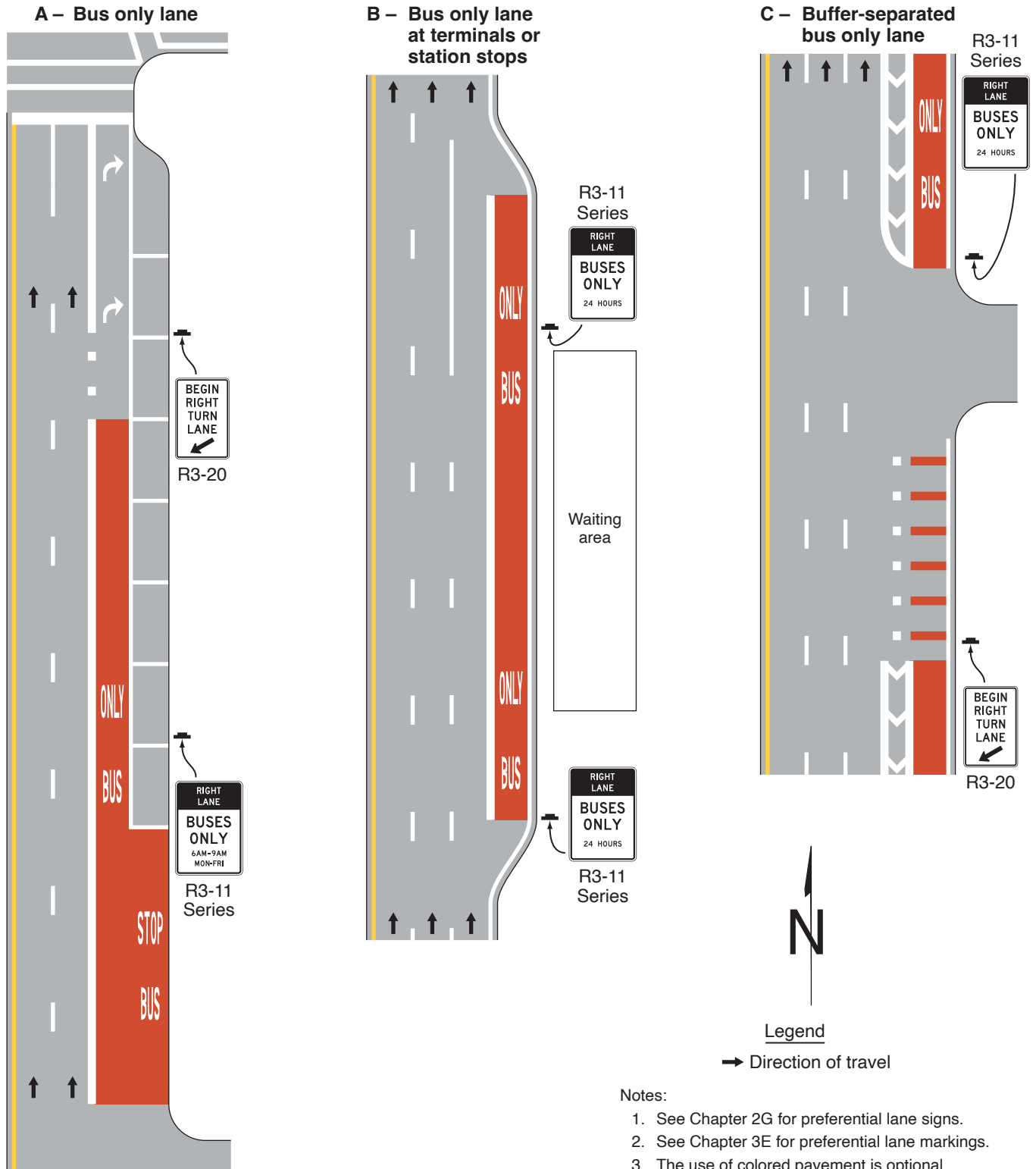
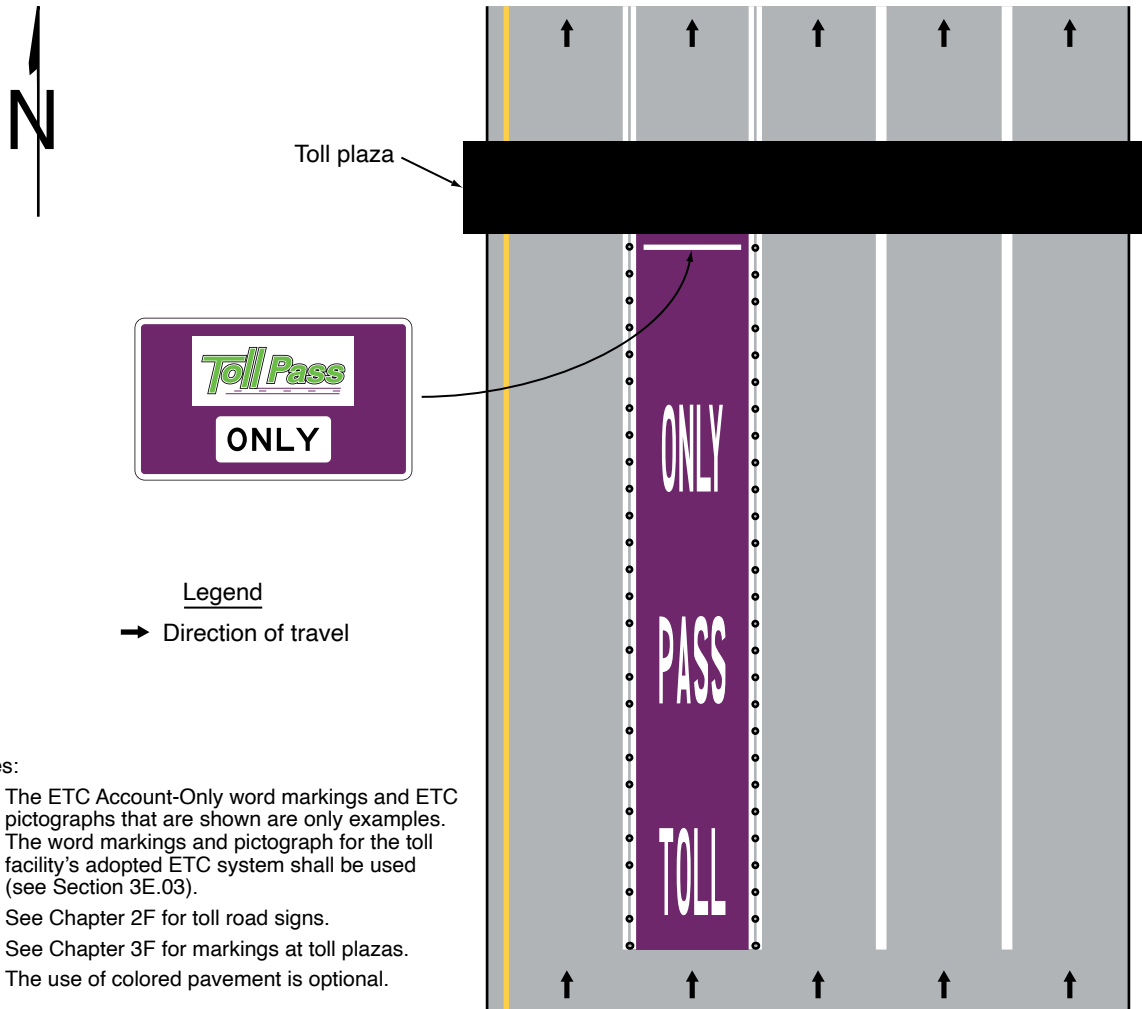




Figure 3H-6. Examples of Purple-Colored Pavement Applications (Sheet 1 of 2)

A – Electronic toll collection only toll plaza lane



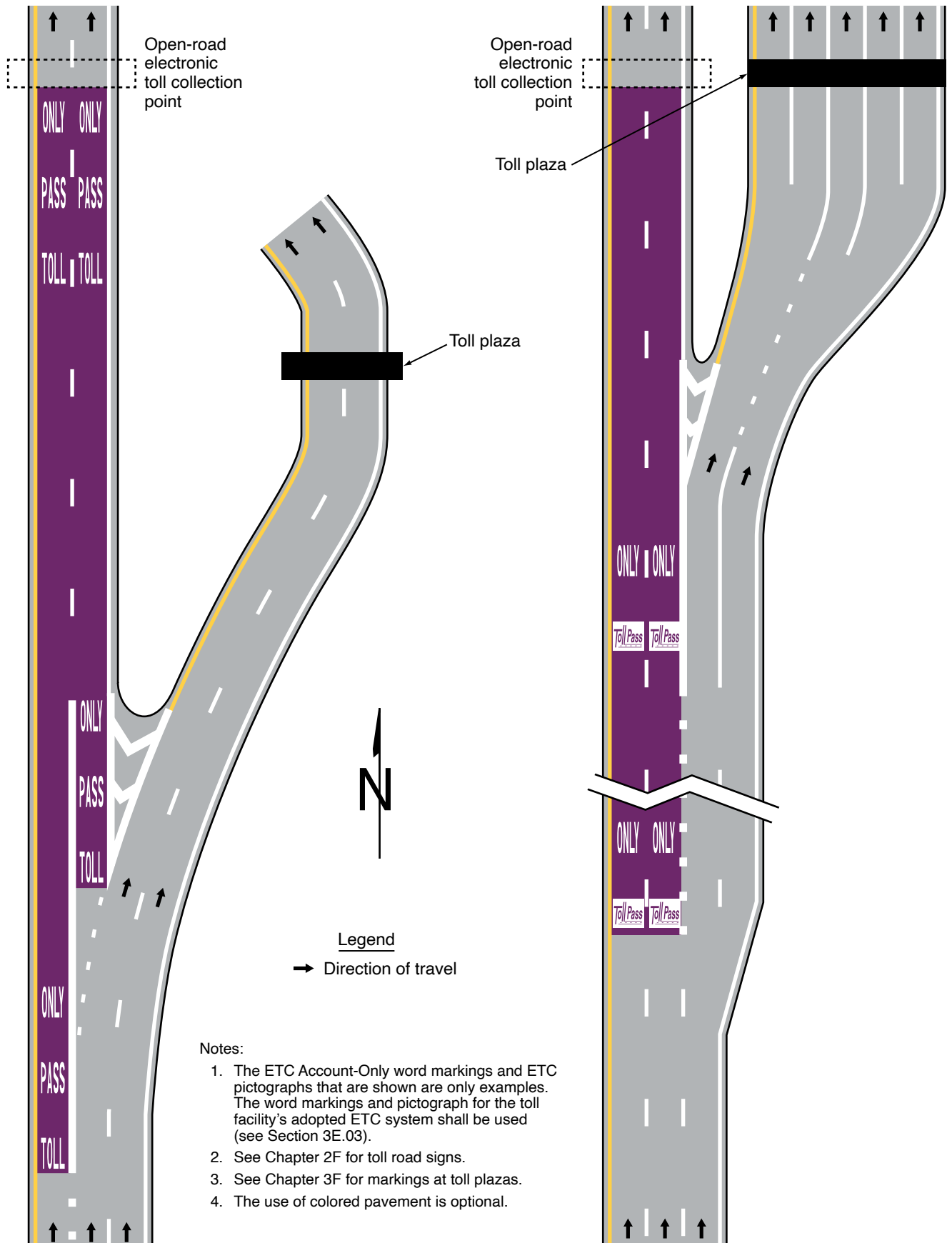
Notes:

1. The ETC Account-Only word markings and ETC pictographs that are shown are only examples. The word markings and pictograph for the toll facility's adopted ETC system shall be used (see Section 3E.03).
2. See Chapter 2F for toll road signs.
3. See Chapter 3F for markings at toll plazas.
4. The use of colored pavement is optional.

**Figure 3H-6. Examples of Purple-Colored Pavement Applications (Sheet 2 of 2)**

**B – Open-road electronic toll collection bypass with upstream option lane**

**C – Open-road electronic toll collection bypass with dedicated approach lanes**



## CHAPTER 3I. CHANNELIZING DEVICES USED FOR EMPHASIS OF PAVEMENT MARKING PATTERNS

### Section 3I.01 Channelizing Devices

Option:

- 01 Channelizing devices (see Sections 6K.01 through 6K.07 and Figure 6K-1) such as cones, tubular markers, vertical panels, lane separators, drums, and barricades may be used for general traffic control purposes such as adding emphasis to reversible lane delineation, channelizing lines, islands, pedestrian facilities, or bicycle facilities. Channelizing devices may also be used along a center line to preclude turns or along lane lines to preclude lane changing, as determined by engineering judgment.

Support:

- 02 Although they are not considered to be traffic control devices, raised islands (see Chapter 3J) are also sometimes used to channelize traffic.

**Standard:**

- 03 **Except for color, the design of channelizing devices, including, but not limited to, retroreflectivity, minimum dimensions, and mounting height, shall comply with the provisions of Chapter 6K.**
- 04 **Except as provided in Paragraph 5 of this Section, the color of channelizing devices used outside of temporary traffic control zones shall be the same color as the pavement marking that they supplement, or for which they are substituted, in accordance with Section 3A.03.**

Option:

- 05 The color of channelizing devices used to emphasize pavement marking patterns outside of temporary traffic control zones may be orange provided that the application of the orange-colored channelizing device is not permanent.

Support:

- 06 Emergency incidents and planned special events are the most common temporary traffic control zones that would justify orange channelizing devices to emphasize standard pavement marking colors. These events do not necessitate police officers or other authorized personnel to obtain and deploy channelizing devices that match the color of the existing pavement marking.

**Standard:**

- 07 **For nighttime use, channelizing devices shall be retroreflective (as described in Part 6) or internally illuminated. On channelizing devices used outside of temporary traffic control zones, retroreflective sheeting or bands shall be white if the devices separate traffic flows in the same direction and shall be yellow if the devices separate traffic flows in the opposite direction or are placed along the left-hand edge line of a one-way roadway or ramp.**

### Section 3I.02 Tubular Markers

**Standard:**

- 01 **Tubular markers for permanent installations shall be a minimum of 28 inches in height and shall be a minimum of 2 inches wide facing road users.**

*Guidance:*

- 02 *Tubular markers should be affixed to the pavement or other surface either directly or by means of an attachment system that is affixed to the pavement or other surface. Tubular markers should normally be spaced no greater than N as cited in Section 3B.14.*

Option:

- 03 Other spacing may be used based on engineering judgment.

Support:

- 04 Tubular markers are sometimes used to provide additional emphasis or improve lane discipline in advance of an unsignalized crosswalk (see Figure 3I-1).

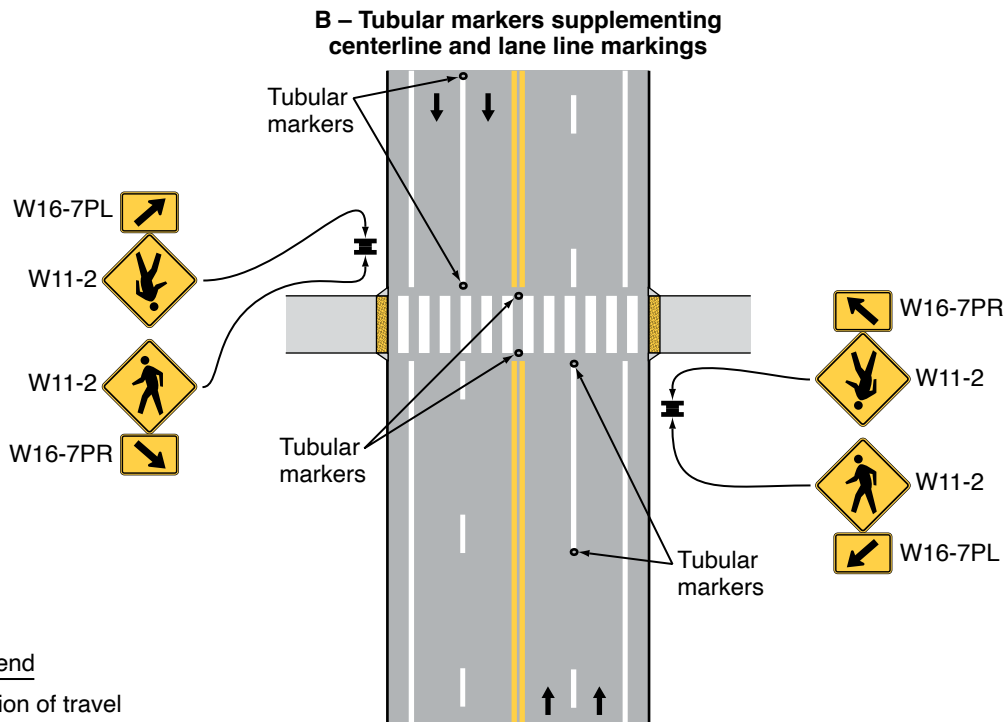
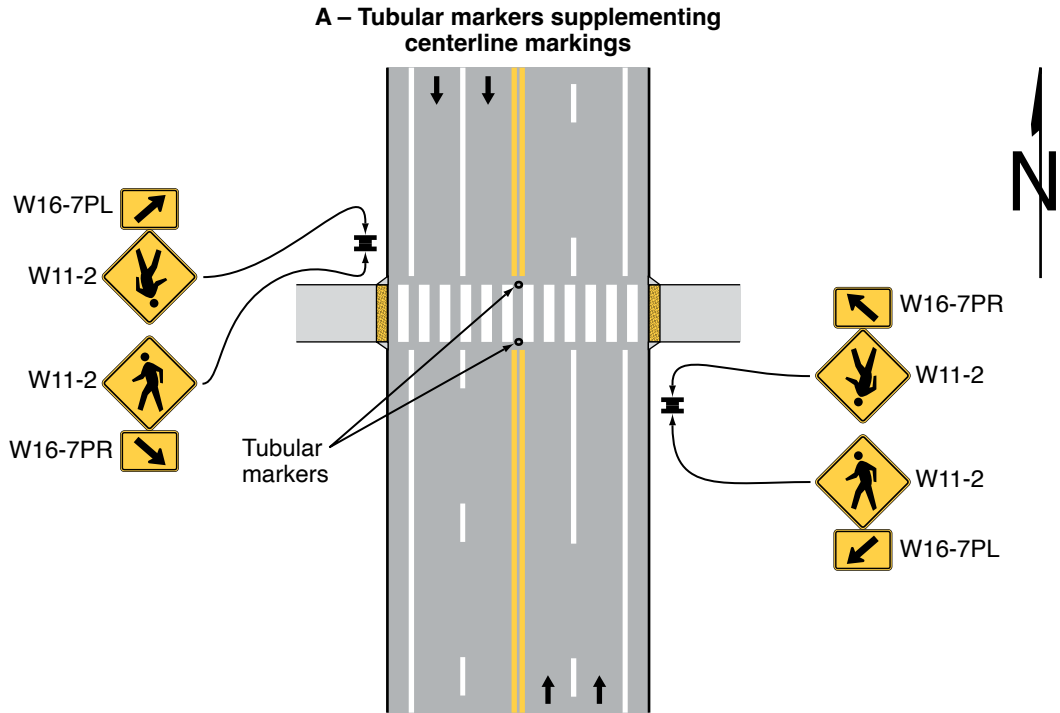
*Guidance:*

- 05 *When tubular markers are used to supplement a RI-6 series sign (see Section 2B.20) that is either on the center line, lane line, or median island, they should not be used on the same pavement marking line where the RI-6 series sign is installed.*

Support:

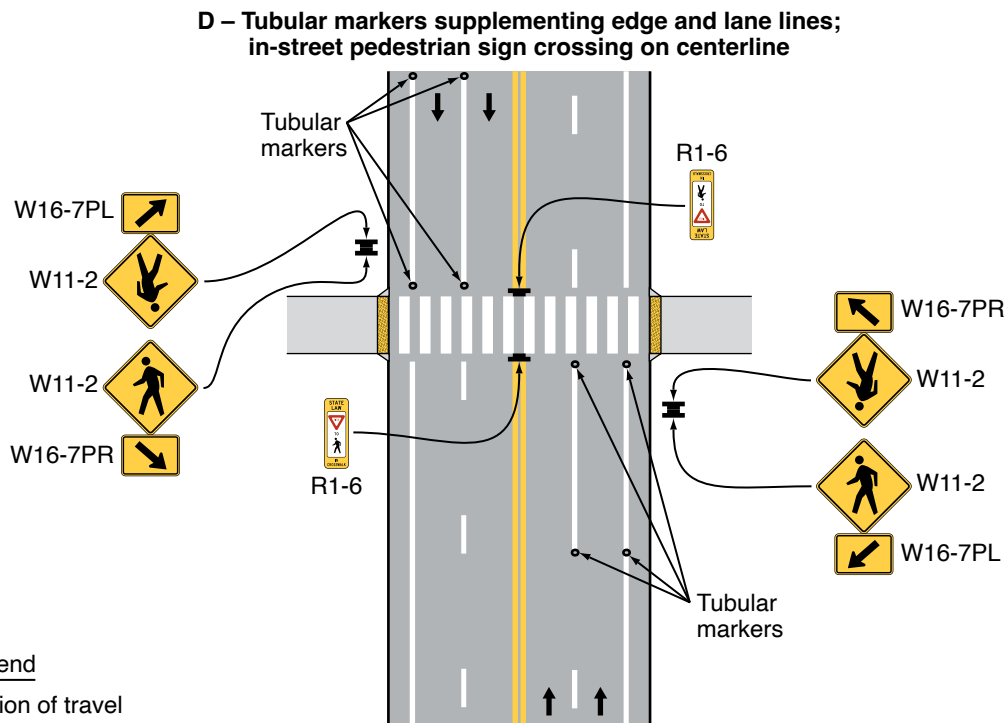
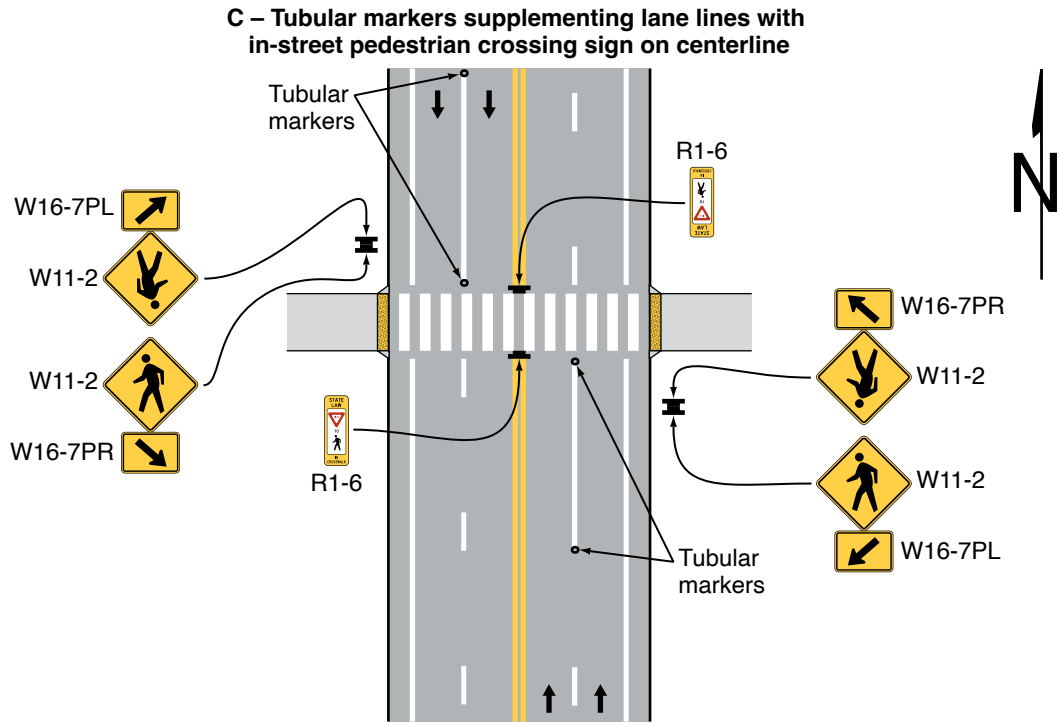
- 06 Section 6K.04 contains information for temporary installations of tubular markers.

**Figure 3I-1. Examples of Tubular Markers Supplementing Pavement Markings in Advance of an Unsignalized Crosswalk (Sheet 1 of 2)**



**Legend**  
→ Direction of travel

**Figure 3I-1. Examples of Tubular Markers Supplementing Pavement Markings in Advance of an Unsignalized Crosswalk (Sheet 2 of 2)**



## CHAPTER 3J. MARKING AND DELINEATION OF ISLANDS AND SIDEWALK EXTENSIONS

### Section 3J.01 General

Support:

- 01 This Chapter addresses the marking and delineation of islands (see definition in Section 1C.02) and sidewalk extensions designated by pavement markings. Definitions, types, sizes, and other criteria for the design of islands are set forth in “A Policy on Geometric Design of Highways and Streets,” 2018 Edition, AASHTO.”
- 02 Section 3C.12 contains information on pedestrian islands and medians.
- 03 Sections 3H.04 and 3H.05 contain information on colored pavement that can be used within islands.

Option:

- 04 An island may be designated by curbs, pavement edges, pavement markings, channelizing devices, or other devices.

### Section 3J.02 Approach-End Treatment

Support:

- 01 An approach-end treatment to an island consists of longitudinal pavement markings and/or channelizing devices upstream of the island followed by a divergence of those pavement markings and/or channelizing devices concluding with a transition to other pavement markings that demarcate or outline the island (see Figure 3J-1).
- 02 Section 3B.13 contains information on pavement markings that function as approach-end treatments for obstructions.

Guidance:

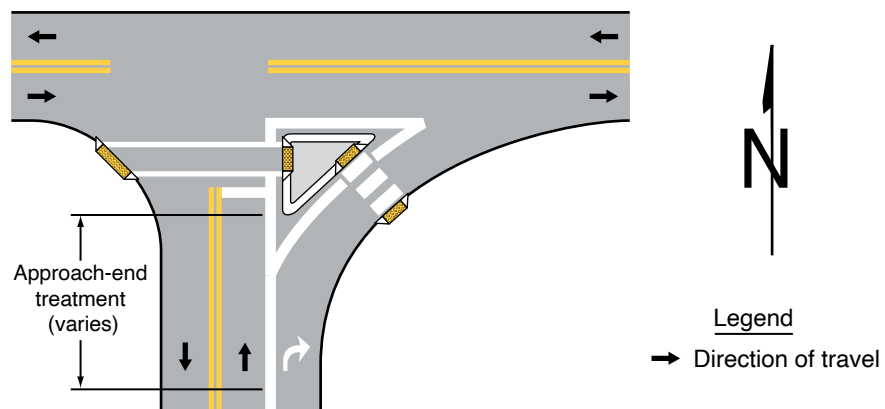
- 03 *The ends of islands first approached by traffic should be marked with an approach-end treatment, curb markings (see Section 3J.04), or both to guide vehicles into desired paths of travel along the island edge.*
- 04 *When raised bars or buttons that project more than 1 inch above the pavement surface are used to create a rumble section in the neutral area, the raised bars or buttons should be marked with white or yellow retroreflective materials, as determined by the direction or directions of travel they separate.*

### Section 3J.03 Islands Designated by Pavement Markings

Standard:

- 01 **Except as provided in Paragraph 2 of this Section, islands formed by pavement markings only shall be established using channelizing lines, and shall be white when separating traffic flows in the same general direction or yellow when separating opposing directions of traffic.**
- 02 **If a continuous flush median island separating travel in opposite directions is used, two sets of double solid yellow lines shall be used to form the island (see Figure 3B-5). Other markings in the median island area, such as diagonal lines (see Section 3B.25), shall also be yellow, except crosswalk markings which shall be white (see Chapter 3C).**
- 03 **If used, chevron or diagonal markings (see Section 3B.25) within the island shall be the same color as the channelizing line.**

**Figure 3J-1. Example of Markings for an Approach-End Treatment to an Island**



Option:

- 04 Both chevron and diagonal markings of the same color may be used within the same island based on engineering judgment.
- 05 The area within the flush island delineated by pavement markings may use colored pavement in accordance with the provisions of Chapter 3H.

Support:

- 06 Figure 3J-2 illustrates examples of islands designated by pavement markings.

**Section 3J.04 Curb Markings for Raised Islands**

**Standard:**

- 01 Where curbs are marked for delineation or visibility purposes, the colors shall comply with the general principles of markings (see Section 3A.03).

*Guidance:*

- 02 *Retroreflective solid yellow curb markings should be placed on the approach ends of raised medians and curbs of islands that are located in the line of traffic flow where the curb serves to channel traffic to the right of the obstruction (see Figure 3J-3).*
- 03 *Retroreflective solid white curb markings should be used when traffic is permitted to pass on either side of the island (see Figure 3J-3).*
- 04 *The retroreflective area should be of sufficient length to denote the general alignment of the edge of the island along which vehicles travel, including the approach end, when viewed from the approach to the island.*

Option:

- 05 Where the curbs of the islands become parallel to the direction of traffic flow or where the island is illuminated or marked with delineators, curb markings may be discontinued based on engineering judgment or study.
- 06 Curb markings at openings in a continuous median island may be omitted based on engineering judgment or study.

**Section 3J.05 Pavement Markings for Raised Islands**

Support:

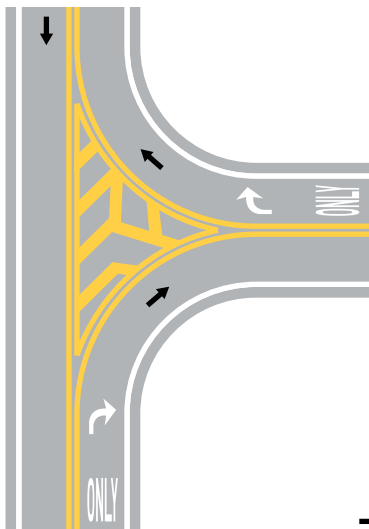
- 01 Pavement markings for raised islands include the approach-end treatment (see Section 3J.02), channelizing lines, edge lines, and chevron or diagonal markings.

Option:

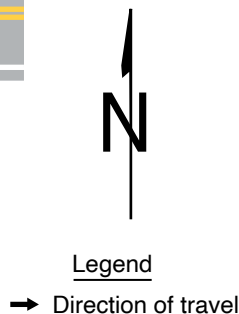
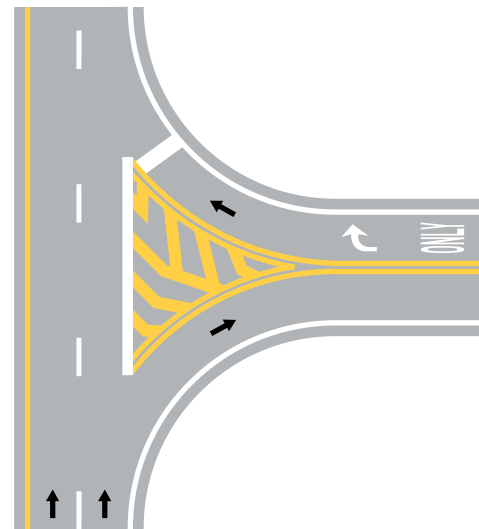
- 02 Solid yellow edge lines (see Sections 3B.09 and 3B.10) may be used adjacent to raised islands separating travel in opposite directions (see Drawing A in Figure 3J-3).

**Figure 3J-2. Examples of Islands Designated by Pavement Markings**

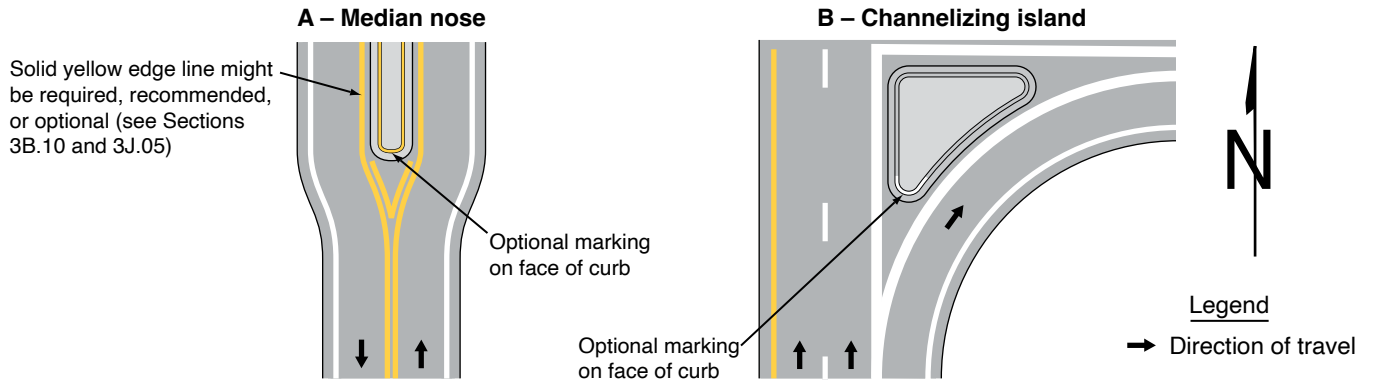
**A – Separating opposing traffic flows in all directions**



**B – Separating opposing traffic flows in an intersecting street**



**Figure 3J-3. Examples of Curb Markings for Raised Islands**



**Standard:**

03 **Except as provided in Paragraphs 4 and 6 of this Section, raised islands separating traffic flows in the same general direction shall be outlined with white channelizing lines (see Drawing A in Figure 3J-4).**

**Option:**

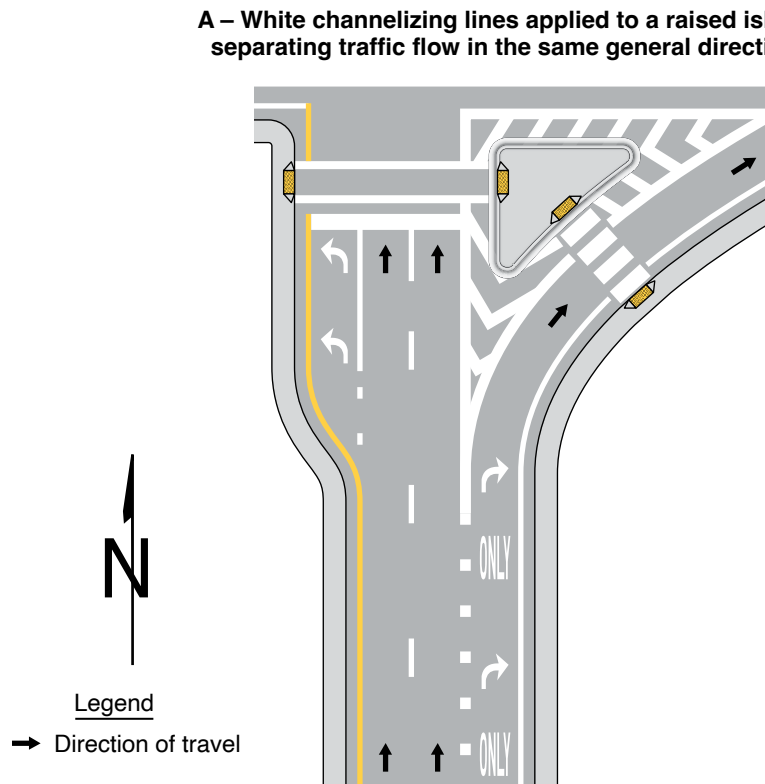
04 Pavement markings for smaller raised islands may be omitted based on engineering judgment.

**Guidance:**

05 *Smaller raised islands without marked channelizing lines, edge lines, or chevron or diagonal markings should use curb markings (see Section 3J.04).*

06 *Where traffic passes on the right of a raised island separating traffic flows in the same general direction, a yellow edge line should be used adjacent to raised islands of discernible size or length instead of continuing the white channelizing line from the approach-end treatment (see Drawing B in Figure 3J-4).*

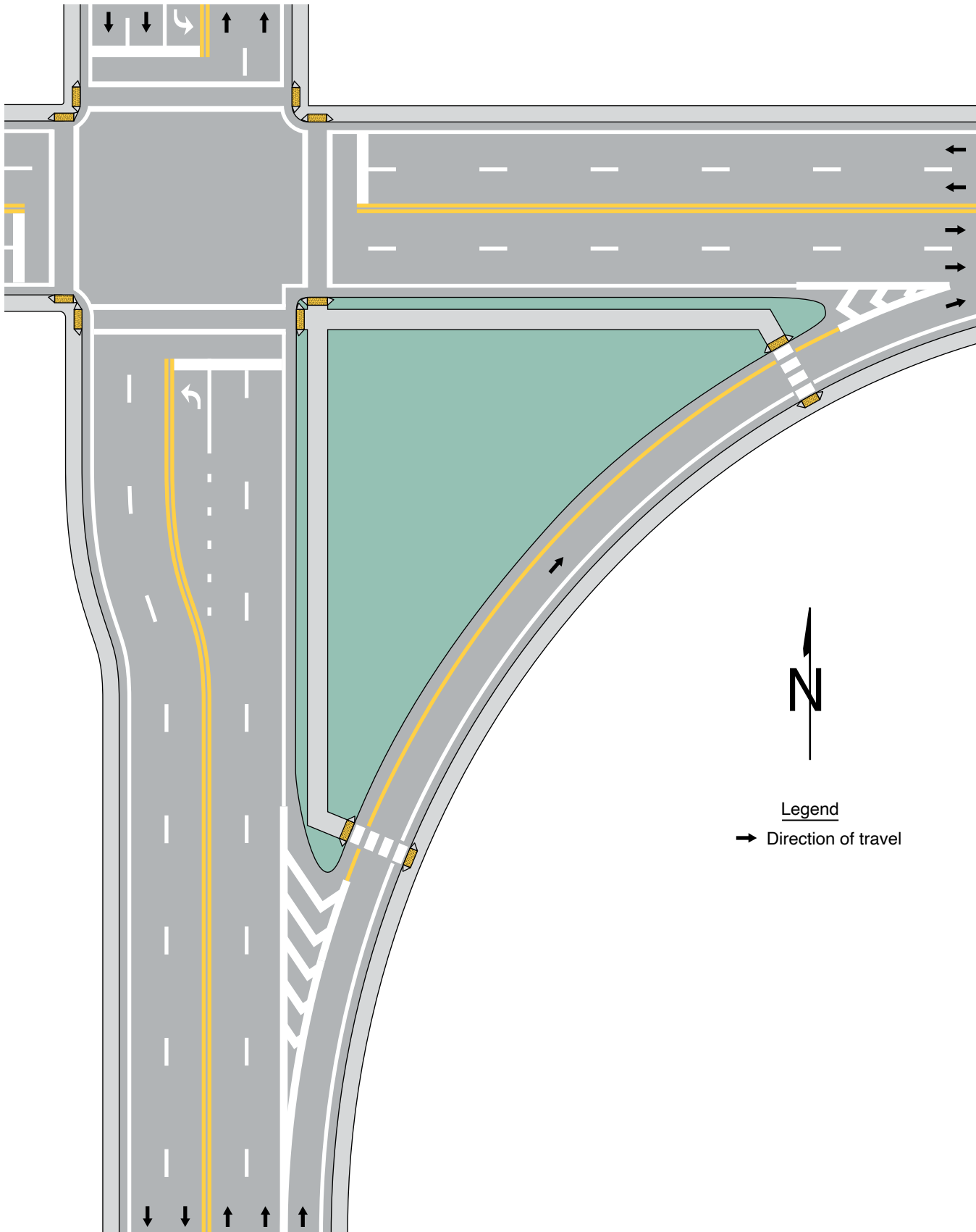
**Figure 3J-4. Examples of Pavement Markings for Raised Islands (Sheet 1 of 2)**





**Figure 3J-4. Examples of Pavement Markings for Raised Islands (Sheet 2 of 2)**

**B – Yellow edge line applied to raised island separating traffic flows in the same general direction**



Support:

- 07 Yellow edge lines adjacent to raised islands that separate traffic flows in the same general direction can be advantageous as a countermeasure for wrong-way entry or travel if the yellow edge line is of discernible length.

Option:

- 08 Chevron markings may be used in neutral areas formed by diverging channelizing lines at raised islands separating traffic flows in the same general direction.

- 09 Diagonal markings of an appropriate color may be used in buffer areas between the channelizing line and the raised island (see Figure 3J-5).

### Section 3J.06 Island Delineation

Standard:

- 01 **Delineators installed on islands shall be the same colors as the related channelizing or edge lines except that, when only facing wrong-way traffic, they shall be red (see Section 3G.03).**

- 02 **Each roadway through an intersection shall be considered separately in positioning delineators to assure maximum effectiveness.**

Option:

- 03 Retroreflective or internally illuminated raised pavement markers of the appropriate color may be placed on the pavement in front of the curb and/or on the top of curbed approach ends of raised medians and curbs of islands, as a supplement to or as a substitute for retroreflective curb markings.

### Section 3J.07 Sidewalk Extensions Designated by Pavement Markings

Support:

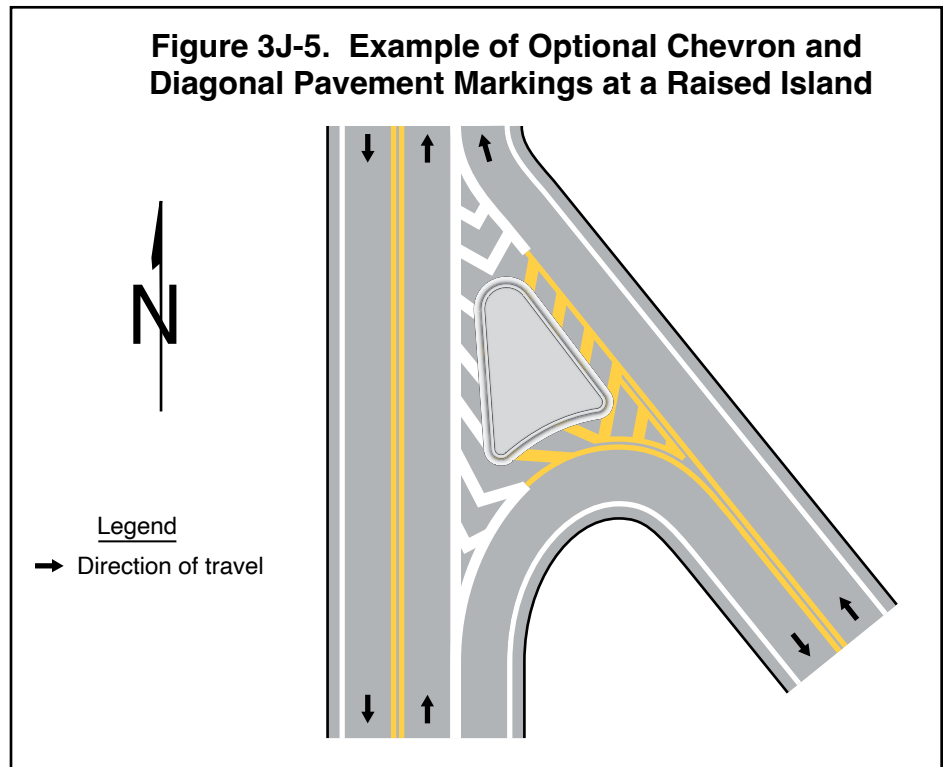
- 01 Sidewalk extensions reclaim a portion of the roadway, sometimes including a portion of parking lanes, shoulders, and/or the traveled way, and repurpose that area for non-vehicular uses. They extend the sidewalk or other pedestrian space, shorten pedestrian crossing distances, alter the roadway geometry for speed management or channelizing, or serve other purposes.
- 02 Sidewalk extensions, sometimes referred to as curb extensions, neckdowns, or bulb-outs, typically are created by physical infrastructure including concrete or asphalt to form a physical narrowing of the roadway with the finished surface at the same level as the adjoining sidewalk.
- 03 Sidewalk extensions can also be designated by pavement markings for temporary or semi-permanent applications in which the finished surface is at the same level as the vehicular travel pavement. Where an adjoining curb and raised sidewalk are present, this type of application results in a multi-level sidewalk due to the difference in elevation between the adjoining pedestrian surfaces.
- 04 Sidewalk extensions designated by pavement markings differ from other paved areas designated by pavement markings that are intended to be traversable by a vehicle for authorized or emergency purposes.

Standard:

- 05 **Sidewalk extensions designated by pavement markings shall be established using double solid lines connecting to the outside physical curb or, in the absence of a curb, to the edge of the roadway. The color of the double solid line shall comply with the provisions of Section 3A.03.**

Support:

- 06 The paved area between the double solid line forming the sidewalk extension designated by pavement markings and the sidewalk or other roadside area is not part of the roadway. Sidewalk extensions designated by



pavement markings formed by double solid lines are distinct from areas such as shoulders or gore areas where travel is discouraged by the presence of a single line, or flush medians where travel is prohibited by a double solid line. Sidewalk extensions designated by pavement markings with double solid lines designate areas outside the roadway where vehicle traversal is prohibited.

07 Areas formed by a single wide line are sometimes used to alter the roadway geometry for speed management or channelizing, or to serve other purposes, where pedestrians are not expected (see Drawing B in Figure 3J-6). These areas are not considered a sidewalk extension, and provisions to delineate areas where vehicle traversal is discouraged include channelizing lines (see Section 3B.08), edge lines (see Section 3B.09), and diagonal markings (see Section 3B.25).

*Guidance:*

08 Channelizing devices such as tubular markers (see Chapter 3I) should be used to provide conspicuity for, and to prevent vehicles from traversing, the area of the sidewalk extension designated by pavement markings. They should be located adjacent to the double solid line outside the traveled way.

*Support:*

09 When selecting other methods of physical separation, the visual contrast from adjoining pavement and maximum separation distances are considerations so they are visible to pedestrians having limited vision and detectable by pedestrians who travel with a long cane.

10 Sight lines and the visibility of road users within the sidewalk extension area are considerations when selecting methods of physical separation.

11 The swept path of turning design or other prevailing vehicle types is a consideration, especially if a larger vehicle is expected to traverse a portion of the sidewalk extension while turning where pedestrians might be present.

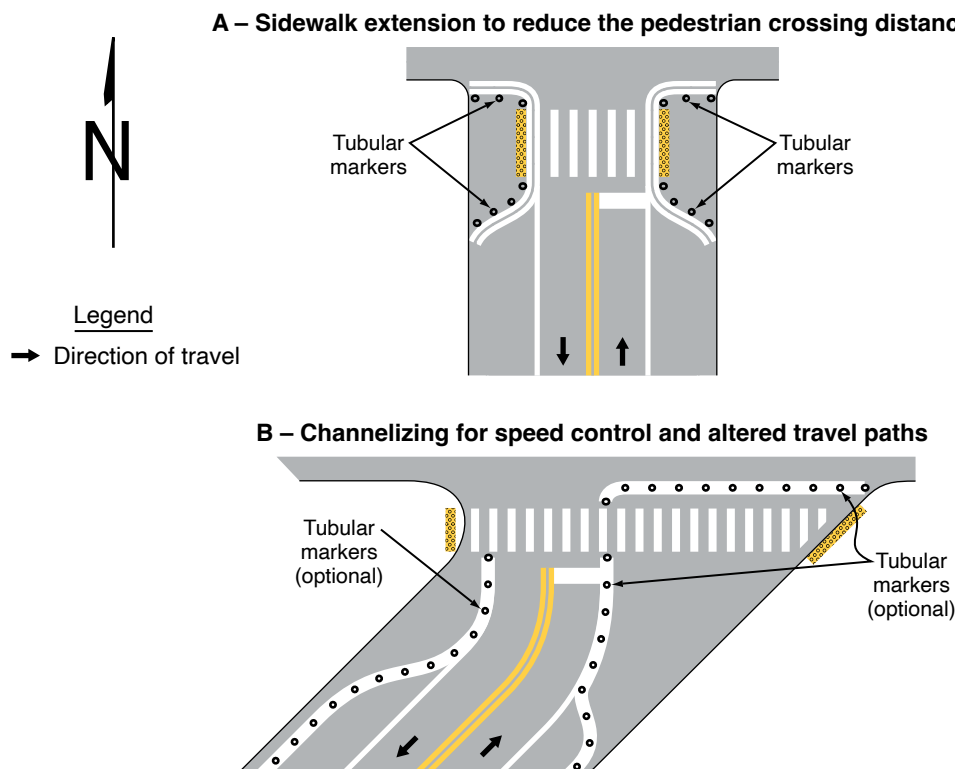
**Standard:**

12 **Crosswalk markings shall not be extended through sidewalk extensions designated by pavement markings.**

*Support:*

13 Accessibility provisions at sidewalk extensions designated by pavement markings are outside the scope of this Manual. State and local organizations providing support services to pedestrians with vision disabilities can provide advice to the traffic engineer on site-specific accessibility decisions. In addition, orientation and mobility

**Figure 3J-6. Examples of Sidewalk Extensions Designated by Pavement Markings and Channelization**



specialists or similar staff can provide advice to inform such decisions. The U.S. Access Board ([www.access-board.gov](http://www.access-board.gov)) provides technical assistance for making pedestrian facilities accessible to persons with disabilities.

*Guidance:*

- 14 *Traffic control devices that are critical to the specific conditions at the sidewalk extension, such as STOP or YIELD signs or Pedestrian Crossing signs, should be located within the sidewalk extension designated by pavement markings. Their lateral offset (see Section 2A.16) should be measured from the center of the double solid line designating a sidewalk extension rather than from the physical curb line behind the sidewalk extension area so that the signs are more visible to approaching traffic and not occluded by any physical features placed within the sidewalk extension area.*

*Support:*

- 15 The location of accessible pedestrian signals (see Section 4K.02) is a consideration when providing a sidewalk extension designated by pavement markings.
- 16 Aesthetic surface treatments (see Chapter 3H) are sometimes used in sidewalk extensions designated by pavement markings to emphasize that the area is outside of the traveled way.

**Standard:**

- 17 **In accordance with the provisions of Section 3H.03, aesthetic surface treatments, if used within a sidewalk extension designated by pavement markings, shall be non-retroreflective.**

*Support:*

- 18 Figure 3J-6 illustrates an example of a sidewalk extension designated by pavement markings and an example of channelizing.

### CHAPTER 3K. RUMBLE STRIP MARKINGS

#### Section 3K.01 Longitudinal Rumble Strip Markings

Support:

01 Longitudinal rumble strips consist of a series of rough-textured or slightly raised or depressed road surfaces intended to alert inattentive drivers through vibration and sound that their vehicle has left the travel lane. Shoulder rumble strips are typically installed along the shoulder near the travel lane. On divided highways, rumble strips are sometimes installed on the median side (left-hand side) shoulder as well as on the outside (right-hand side) shoulder. On two-way roadways, rumble strips are sometimes installed along the center line.

02 This Manual contains no provisions regarding the design and placement of longitudinal rumble strips. The provisions in this Manual address the use of markings in combination with a longitudinal rumble strip. Figure 3K-1 illustrates markings used with or near longitudinal rumble strips.

03 Section 6M.06 contains information related to longitudinal rumble strips.

Option:

04 An edge line or center line may be located over a longitudinal rumble strip to create a rumble stripe.

Standard:

05 The color of an edge line or center line associated with a longitudinal rumble stripe shall be in accordance with Section 3A.03.

06 An edge line shall not be used in addition to a rumble stripe that is located along a shoulder.

#### Section 3K.02 Transverse Rumble Strip Markings

Support:

01 Transverse rumble strips consist of intermittent narrow, transverse areas of rough-textured or slightly raised or depressed road surface that extend across the travel lanes to alert drivers to unusual vehicular traffic conditions. Through noise and vibration, they attract the attention of road users to features such as unexpected changes in alignment and conditions requiring a reduction in speed or a stop.

02 This Manual contains no provisions regarding the design and placement of transverse rumble strips that approximate the color of the pavement. The provisions in this Manual address the use of markings in combination with a transverse rumble strip.

03 Section 6M.06 contains information related to transverse rumble strips.

Standard:

04 Except as otherwise provided in Section 6M.06 for TTC zones, if the color of a transverse rumble strip used within a travel lane is not the color of the pavement, the color of the transverse rumble strip shall be either black or white.

Guidance:

05 White transverse rumble strip markings used in a travel lane should not be placed in locations where they could be confused with other transverse markings such as stop lines or crosswalks.

Figure 3K-1. Examples of Longitudinal Rumble Strip Markings

