

# SUWANNEE RIVER WATER MANAGEMENT DISTRICT

## ENVIRONMENTAL RESOURCE PERMIT APPLICANT'S HANDBOOK VOLUME II

(DESIGN REQUIREMENTS FOR STORMWATER  
TREATMENT AND MANAGEMENT SYSTEMS)

Effective July 2024

FOR USE WITHIN THE GEOGRAPHIC LIMITS OF THE  
SUWANNEE RIVER WATER MANAGEMENT DISTRICT

Incorporated by Reference in Rules 62-330.010 and 40B-400.091, F.A.C.



## TABLE OF CONTENTS

<b>PART I – INTRODUCTION, ORGANIZATION, APPLICABILITY</b>		
1.1	Introduction, Criteria, Policy, and Purpose	5
1.1.1	Introduction	5
1.1.2	Criteria Objectives	5
1.1.3	Policy and Purpose	6
1.2	Thresholds	6
1.3	Exemptions	6
<b>PART II – GENERAL CRITERIA</b>		
2.1	Definitions and Acronyms	7
2.1.1	Definitions	7
2.1.2	Acronyms	9
2.2	Fees and Surety	10
2.2.1	Fees	10
2.2.2	Surety	10
2.3	General Design and Performance Criteria	10
2.4	Pre-Application Conference	12
2.5	Professional Certification	12
2.6	Surveys	13
2.7	Computer Models	13
2.8	Flexibility for State Transportation Projects and Facilities	13
2.9	Redevelopments and Retrofits of Existing Stormwater Management Systems	13
<b>PART III – STORMWATER QUANTITY/FLOOD CONTROL</b>		
3.1	General	15
3.1.1	Factors Influencing Water Quantity	15
3.1.2	Antecedent Moisture Conditions	15
3.2	Design Storms	15
3.3	Discharge Rates and Volumes	16
3.3.1	Methodologies for Calculating Discharge	16
3.4	Recovery	16
3.4.1	Percolation and Water Table	17
3.4.2	Mounding	17
3.5	Compensating Stormwater Treatment	17
3.6	Floodplain Delineation	17
3.6.1	Static Systems	18
3.6.2	Floodplain Storage and Conveyance	18
3.6.3	Importer/Exporter (Site Storage Capacity)	18
3.6.4	Compensating Storage	18
3.6.5	Dynamic Systems	19
3.6.6	“No-Rise” Requirements for Floodways	19
3.7	Determination of Tailwater Conditions	19
3.7.1	Topographical Information	19
3.7.2	Surface Profile	20
3.8	Low Flow and Base Flow Maintenance	20

<b>PART IV – ADDITIONAL STORMWATER QUALITY REQUIREMENTS</b>		
4.1	General	21
4.1.1	Factors Influencing Water Quality	21
4.2	Dewatering	21
4.3	State Water Quality Standards	21
4.4	Recovery	22
4.5	Erosion and Sediment Control	22
4.5.1	Side Slopes	22
4.6	Pollutant Control	22
4.6.1	Pre-Treatment	22
4.6.2	Oil and Grease Control	22
4.7	Runoff Coefficients and Curve Numbers for Stormwater Systems	23
<b>PART V – BEST MANAGEMENT PRACTICES</b>		
5.1	Retention Pond Design Criteria and Guidelines	24
5.1.1	Description	24
5.1.2	Criteria	24
5.2	Dry Detention Pond Design Criteria and Guidelines	24
5.2.1	Description	24
5.2.2	Criteria	25
5.3	Exfiltration Trench Systems Design Criteria and Guidelines	25
5.3.1	Description	25
5.3.2	Criteria	25
5.4	Wet Detention Pond Design Criteria and Guidelines	26
5.4.1	Description	26
5.4.2	Criteria	26
5.4.3	Permanent Pool	26
5.5	Swale System Design Criteria and Guidelines	26
5.5.1	Description	26
5.5.2	Criteria	27
5.6	Vegetated Natural Buffers Design Criteria and Guidelines	27
5.6.1	Description	27
5.6.2	Criteria	27
5.7	Borrow Pits and Ponds Design Criteria and Guidelines	28
5.7.1	Description	28
5.7.2	Criteria	28
5.8	Dams and Impoundments Design Criteria and Guidelines	28
5.8.1	Description	28
5.8.2	Criteria	29
5.8.3	Embankment Slope Stability	29
5.8.4	Construction Standards	29
5.8.5	Principle Spillways	31
5.8.6	Emergency Spillways	32
5.8.7	Reservoir Regulation	32
5.9	Sensitive Karst Area Design Criteria and Guidelines	32
5.9.1	Background of the Sensitive Karst Areas	32
5.9.2	Hydrogeology of the Sensitive Karst Areas	32
5.9.3	Design Criteria for Sensitive Karst Areas	33

**PART VI – OPERATION AND MAINTENANCE**

6.1	General	34
6.2	Entity Requirements	34
6.3	Operation Phase and Release of Bond	34
6.4	Inspections and Reporting	34
6.5	Compliance	34
6.6	Enforcement	34

**PART VII – APPENDICES**

	Appendix A – District Maps and Boundaries	35
	Appendix B - Design Storms	41

## **PART I – INTRODUCTION, ORGANIZATION, APPLICABILITY**

### **1.1 Introduction, Criteria, Policy, and Purpose**

#### **1.1.1 Introduction**

Applicant’s Handbook Volume II accompanies Chapter 62-330, F.A.C., and the Applicant’s Handbook Volume I (General and Environmental). Applicant’s Handbook Volume I is applicable to all environmental resource permit (ERP) applications, and provides:

- Background information on the ERP program, including points of contact;
- A summary of the statutes and rules that are used to authorize and implement the ERP program;
- A summary of the types of permits, permit thresholds, and exemptions; and
- The general, water quality, and environmental criteria used for ERP evaluations.

This Volume is designed to be applicable only to those ERP applications that involve the design of a stormwater management system that requires a permit as provided in Chapter 62-330, F.A.C.

The ERP program regulates all types of stormwater management systems, including dams, impoundments, reservoirs, appurtenant work, or works, and dredging or filling, as those terms are defined in Sections 373.403(13) and (14), F.S., or any combination thereof. These terms are defined in Sections 373.019 and 373.403, F.S., and in Section 2.1 of this Volume. A stormwater management system is defined in Sections 373.403(10) and 403.031(16), F.S., as a system that is designed and constructed or implemented to control discharges which are necessitated by rainfall events, incorporating methods to collect, convey, store, absorb, inhibit, treat, use, or reuse water to prevent or reduce flooding, over drainage, environmental degradation, and water pollution or otherwise affect the quantity and quality of discharges from the system.

Therefore, this Volume generally is not applicable to activities that do not generate more than an incidental amount of stormwater runoff, such as:

- Dredging and filling to construct such things as most “stand-alone” seawalls and docks and “in water” types of activities, such as channel dredging; but not including dredging and filling in wetlands or other surface waters to construct such things as bridges or culverted road crossings, parking areas, building sites, or land fills that may or may not contain structures;
- Semi-impervious piers (i.e., slatted decking) that do not convey vehicular traffic; but not including such things as wharfs at a port facility;
- Construction of an individual, single family residences, duplex, triplex, or quadruplex that are not part of a larger plan of development;
- “Stand-alone” dredging, including maintenance dredging;
- Activities that do not add new impervious surfaces, such as the installation of overhead and buried electric and communication transmission and distribution lines.

This Volume provides specific, detailed information to meet the water quality system and quantity design requirements of stormwater management systems. Such systems are regulated by the Suwannee River Water Management District (District) through the ERP program authorized under Section 373.4145, F.S. This Volume explains and provides more detail on the rule criteria for stormwater quality and quantity contained in Chapter 62-330, F.A.C. In cases where conflicting or ambiguous interpretations of the information in this Volume results in uncertainty, the final determination of appropriate procedures to be followed will be made using Chapters 120 and 373, F.S., and applicable F.A.C. rule chapters. Both Applicant’s Handbook Volumes I and II are adopted by reference in Chapter 62-330, F.A.C., and, as such, are rules of the Department and the District. The Handbooks are written to provide more detail and clarity to the public in understanding the statutory and rule provisions that implement the ERP program.

#### **1.1.2 Criteria Objectives**

The criteria contained herein were established with the primary goal of meeting District water resource objectives as set forth in Chapter 373, F.S. Performance criteria are used where possible. Other methods of meeting overall objectives and which meet the conditions for issuance set forth in Rules 62-330.301 and 62-330.302, F.A.C., will be considered. Compliance with the criteria herein constitutes a presumption that the project proposal is in conformance

with the conditions for issuance set forth in Rules 62-330.301 and 62-330.302, F.A.C. Pursuant to Section 373.4131, F.S., if a stormwater management system is designed in accordance with the criteria in this Volume or if a system is constructed operated, and maintained for stormwater treatment in accordance with a valid ERP or exemption under Part IV of Chapter 373, F.S., the discharges from the system are presumed not to violate applicable state water quality standards.

### **1.1.3 Policy and Purpose**

This Volume is intended to:

1. Prevent increase in existing flood hazards or damages by requiring that new development of water and related land resources:
  - a. Not restrict floodway conveyance through the use of fill or other obstructions;
  - b. Maintain pre-development rates of stormwater runoff and/or total volume of stormwater runoff as may be appropriate to the project and hydrologic conditions of the developed land;
  - c. Not reduce net storage volumes (including wetland, depression, and soil storage volumes) within a project area; and
  - d. That new development which occurs in flood-prone areas is made flood resistant to the greatest extent practical, or that development which cannot be made flood resistant is not permitted in flood-prone areas.
2. Prevent pollution of waters by requiring control of post-development runoff from such areas to the extent necessary to ensure minimum state water quality standards are met.
3. Preserve fish and wildlife by ensuring that new development preserves or mitigates the conversion of water related habitats.
4. Prevent excessive drainage which will have an adverse impact on aquifer recharge or which would result in permanent conversion of wetlands to an upland area.
5. Prevent the adverse alterations of drainage areas, watershed boundaries, and the interbasin transfers of surface water.

Further, it is the policy of the District that non-mechanical flood control methods are preferable to mechanical methods (e.g., pumps, valves, flashboard risers, etc.); and, therefore, it is the intent of the District not to support, sponsor, build, or otherwise initiate a mechanical public works flood control or drainage project intended to support new development; nor to assume maintenance or operational responsibility of such projects.

### **1.2 Thresholds**

There are no additional thresholds for this District.

### **1.3 Exemptions**

There are no additional exemptions for this District.

## **PART II – GENERAL CRITERIA**

### **2.1 Definitions and Acronyms**

#### **2.1.1 Definitions**

Additional Definitions can also be found in Applicant’s Handbook Volume I.

“100-Year Flood/One Percent Annual Chance of Flood” means that flood which has a one-percent probability of recurrence in any one year. The 100-year flood/one percent annual chance of flood elevation is the highest elevation of flood waters during the 100-year flood/one percent annual chance of flood and is calculated or estimated from the best available information. The 100-year flood/one percent annual chance of flood elevation shall not include coastal storm surge elevations unless such elevations have been developed in an approved Federal Emergency Management Agency Flood Insurance Study and such approved storm surge elevations have been accepted for implementation by the appropriate unit of local or state government.

“Base Flood Elevation” means the highest water surface elevation with a one percent chance of being equaled or exceeded in a given year.

“Closed Basin” means a watershed in which the stormwater runoff does not have a surface water connection to the ocean during a 100-year flood event.

“Closed System” means any reservoir or works located entirely within agricultural lands owned or controlled by the user and which requires water only for the filling, replenishing, and maintaining the water level thereof.

“Control Elevation” means the lowest elevation at which water can be released through the control device or withdrawn by a stormwater reuse system. Sometimes referred to as the invert elevation.

“Control Structure (Control or Bleed-down Device)” means the element of a discharge structure which allows the gradual release of water under controlled conditions. Examples include orifices, notches, weirs, and effluent filtration systems.

“Critical Duration” means the length of the storm event that produces the largest difference between post-development and pre-development peak flow or volume without routing post-development hydrographs through a stormwater management system.

“Development” means any man-made change to improved or unimproved real estate including but not limited to, construction of surface water management systems, works, appurtenant works, structures, mining, dredging, filling, grading, paving, excavation, drilling operations, development of sewage disposal systems, or the alteration of the topography of a tract of land for purposes consistent with the occupation of agriculture, silviculture, floriculture, or horticulture including agricultural closed systems.

“Discharge Structure” means a structural device, usually of concrete, metal, etc., through which water is discharged from a project to the receiving water.

“Earthen Dam” means a water impoundment in which the principal barrier is an embankment of earth or rock fill or combination of earth and rock fill.

“Elevation” means the height in feet above mean sea level according to National Geodetic Vertical Datum or North American Vertical Datum.

“Emergency Spillway” means the discharge structure designed to convey excess water through, over, or around a dam.

“Emergency Spillway Hydrograph” means the hydrograph used to establish the dimensions of the emergency spillway.

“Floodway” or “Regulatory Floodway” means the channel of a river, stream, or other watercourse and adjacent land areas that must be reserved in order to discharge the 100-year flood/one percent annual change of flood without cumulatively increasing the 100-year flood/one percent annual chance of flood elevation more than a designated height.

“Freeboard” means the height between the maximum design water level and the top of the stormwater management system.

“Normal Water Level” means the static design water elevation used when determining stage/storage design computations in a retention or detention area.

“Open Basin” means a watershed in which the stormwater runoff has a surface water connection to the ocean during a 100-year flood event.

“Operation and Maintenance” means any activity or repair required to keep a stormwater management system functioning as permitted and designed.

“Overflow Elevation” means the design elevation of a discharge structure at or below which water is contained behind the structure, except for that which leaks or bleeds out, through a control device down to the control elevation.

“Piping” means progressive erosion of soil within the dam, starting downstream and working upstream, creating a tunnel into the dam. Piping occurs when the velocity of the flow of seepage water is sufficient for the water to transport material from the embankment.

“Pre-Development” means development that was completed prior to the implementation date of Rule 40B-4.1030, F.A.C.

“Post-Development” means development that was not completed prior to the implementation date of Rule 40B-4.1030, F.A.C.

“Principal Spillway” means the lowest spillway designed to convey water from the reservoir at predetermined release rates.

“Rolled Dam” means a water impoundment constructed of fill placed in layers which are mechanically compacted individually prior to placement of the next higher layer.

“Storage Capacity (of a dam)” means the volume of water impounded by the structure below the emergency spillway crest; or if no emergency spillway is used, the volume of water impounded below the top of the structure, less any freeboard.

“Tailwater Level (of a dam)” means the elevation of the water at the downstream toe. “Toe

(of a dam)” means the junction between the face of the dam and the adjacent terrain.

“Underdrain” means a drainage system installed beneath a stormwater holding area to improve the infiltration and percolation characteristics of the natural soil when permeability is restricted due to periodic high water table conditions or the presence of layers of fine textured soil below the bottom of the holding area. These systems usually consist of a system of interconnected below-ground conduits such as perforated pipe, which simultaneously limit the water table elevation and intercept, collect, and convey stormwater which has percolated through the soil.

“Works of the District” means those projects and works including, but not limited to, structures, impoundments, wells, streams, and other watercourses, together with the appurtenant facilities and accompanying lands, which have been officially adopted by the governing board as works of the district. Works of the district officially adopted by the board are adopted by rule in Rule 40B-4.3000, F.A.C.



## 2.1.2 Acronyms

### List of Commonly Used Acronyms

<b>Acronym</b>	<b>Definition</b>
AMC	Antecedent Moisture Condition
BMP	Best Management Practice
CFR	Code of Federal Regulations
cfs	Cubic feet per second
District	Suwannee River Water Management District
ERP	Environmental Resource Permit
FAC	Florida Administrative Code
FDEP	Florida Department of Environmental Protection
FEMA	Federal Emergency Management Agency
FSE&SCIM	Florida Stormwater, Erosion & Sedimentation Control Inspector's Manual
FWC	Florida Fish and Wildlife Conservation Commission
FS	Florida Statutes
GPS	Global Positioning System
HSG	Hydrologic Soil Group
I/Ptotal	Intensity/Total Precipitation
MOA	Memorandum of Agreement
N/A	Not applicable
NRCS	Natural Resources Conservation Service
NWL	Normal Water Level
OFW	Outstanding Florida Water
O&M	Operation and Maintenance
PMP	Probable Maximum Precipitation
P/Ptotal	Precipitation/Total Precipitation
ROMA	Regional Offsite Mitigation Areas
SHGWT	Seasonal High Groundwater Table
SRWMD	Suwannee River Water Management District
T	Time
USFWS	United States Fish and Wildlife Service
USGS	United States Geological Survey
VNB	Vegetated Natural Buffer
VVRS	Vertical Volume Recovery System
WOD	Works of the District
WQTS	Water Quality Treatment System
WQTV	Water Quality Treatment Volume

## **2.2 Fees and Surety**

### **2.2.1 Fees**

A non-refundable permit processing fee as specified by Rule 40B-1.706, F.A.C., is required for the processing of each permit application or for a permit modification; and must be submitted concurrently with the filing of an application or the notice of intent. An application or notice submitted without the fee will not be considered complete.

### **2.2.2 Surety**

Surety for certification of completion of construction shall be required as per Rule 40B-1.704, F.A.C., for projects that propose new stormwater systems. Projects that propose to use existing systems or make minor modifications to existing systems will not require the surety. Projects that do not propose a stormwater system will not be required to provide the surety. Upon completion of the project in accordance with the permitted plans and specifications, submittal of the required as-built certification package and transfer of the permit to the operation and maintenance phase the bond will be released.

## **2.3 General Design and Performance Criteria**

All activities shall meet and comply with the applicable requirements in Part II and VI of this Volume, and Applicant's Handbook Volume I. Activities that require a stormwater management system under Chapter 62-330, F.A.C. shall meet all the applicable requirements of Parts II, III and IV of this Volume, and Applicant's Handbook Volume I. Design criteria can be found in Part V of this Volume.

For the purposes of this District, the conditions in Rule 62-330.301, F.A.C. are further explained as the following:

62-330.301(1)(a), F.A.C. The system or work will not cause excessive drainage of surface water or permanent dewatering of surficial aquifers.

62-330.301(1)(b), F.A.C. The system or work will not increase flood hazards outside the project area nor increase flood hazards which may affect the health, safety, and general welfare of persons residing within the project area.

62-330.301(1)(c), F.A.C. The system or work will not reduce surface water storage volumes within the project area.

62-330.301(1)(d), F.A.C. The system or work will have minimum adverse environmental impacts including impacts to fish, wildlife, wetlands, or other natural resources.

62-330.301(1)(e), F.A.C. Waters discharged or percolated from the system or work will receive a minimum level of stormwater treatment necessary to comply with appropriate state water quality standards.

62-330.301(1)(h), F.A.C. The new surface water management systems or individual works shall not facilitate development in a work of the district if such developments will have the potential of reducing floodway conveyance.

62-330.301(1)(j), F.A.C. The system or work will be maintained and operated in a manner consistent with the provisions in Applicant's Handbook Volume I and Part VI of this Volume.

The District will not approve the issuance of permits for existing systems which are in violation of law or which have discharge to surface waters of the state that is in violation of a permit condition of any unit of local, state, or federal government or which presents an immediate danger to public health or safety.

The system or work will not cause erosion, and any activities or land uses served by the system or work will not create erosion or sedimentation which may render the system unserviceable or degrade receiving waters.

The new surface water management systems or an individual work shall not utilize contiguous wetlands or dilution in waters of the state to achieve required stormwater treatment levels.

Finished floor elevations are required for all buildings. Buildings shall be elevated on piles such that the lowest structural member of the first floor is one foot above the 100-year flood elevation, or in the case of monolithic slab

construction, the finished slab elevation shall be one foot above the 100-year flood elevation.

Roads with public access must be constructed and laid out in conformance with the minimum standards of local government. In the absence of local government standards for roads and associated surface water management systems, the following minimum standards shall apply:

1. Driving surface shall be stabilized soil, according to the latest edition of the Florida Standard Specification for Road and Bridge Construction.
2. Two driving lanes with a minimum driving surface of 16 feet.
3. Driving surface shall be sloped to drain at a minimum of two percent (2%).
4. Culverts shall be used to maintain pre-development drainage patterns up to the 10-year, 24-hour storm event.
5. Swales shall be used for water quality treatment with a maximum slope of three-to-one (3:1) and erosion shall be controlled with grass or other equivalent method.

All storage volumes in detention or retention systems shall be calculated so as not to include any volumes below the average seasonal high groundwater table for the project area.

Surface water management systems must not alter contributing areas or watershed boundaries of any watershed or basin not wholly contained within the project area.

There must be no reduction of floodway conveyance within the project area.

Systems serving a use that produces or stores hazardous or toxic substances shall be designed to have no stormwater discharge that contains such substances.

Stagnant water conditions such as hydraulically dead-end canals are to be avoided, regardless of the type of development.

Legal authorization, such as an easement, deed restrictions, or other instrument must be provided establishing a right-of-way or access for maintenance of the stormwater management system unless the operation and maintenance entity wholly owns or retains ownership of the property. The following are requirements for specific types of maintenance access easements:

1. Easements must cover at least the primary and high maintenance components of the system (e.g., inlets, outlets, littoral zones, filters, pumps, trenches, etc.), including provisions for equipment to enter and perform the necessary maintenance on the system. Applicants may propose site-specific easements that meet this requirement.
2. Easements for water bodies, open conveyance systems, stormwater basins, and storage areas must: (a) Include the area of the water surface measured at the top of the pond and at the control elevation, and (b) be traversable by maintenance equipment.
3. Access easements from a public road or public right-of-way to the stormwater management system must be 20 feet in width.

Applicants who propose to use offsite areas that are not under their ownership or control must obtain sufficient legal authorization prior to permit issuance to use the area in order to satisfy the requirements for issuance specified in Chapter 62-330, F.A.C., Applicant's Handbook Volume I, or this Volume. Any alteration to stormwater discharges to adjacent properties resulting from permitted activities, such as increase of flow or change of discharge location, also requires appropriate legal authorization. A copy of the legal authorization must be submitted with the permit application. As part of the determination as to whether a dam meets the criteria in Rule 62-330.301, F.A.C., and this section, a dam over five feet in height (as measured from the crest of the dam to the lowest elevation on the downstream toe) with the potential to store 50 acre feet or more of water, and any dam 10 feet or more in height must be designed, constructed, operated, and maintained consistent with generally accepted engineering practice as applied to local conditions, considering such factors as: the type of materials used to construct the dam, the type of soils and degree of compaction, hydrologic capacity, construction techniques, and downstream hazard potential (referenced in Section 8.4.5 and Appendix L in Applicant's Handbook Volume I). An additional document that provides useful information for this purpose is *Design of Small Dams*, U.S Department of Interior, Bureau of Reclamation, Third Edition (2006).

## 2.4 Pre-application Conference

Pre-application meetings are encouraged. The purpose of a pre-application meeting is to identify issues that need to be addressed in detail such as:

1. Application completion, processing, and evaluation procedures;
2. Information that will be required for evaluation of the application;
3. Information regarding surface water data that is known to be available at that time;
4. The criteria that will be used to evaluate the application; and
5. Other hydrologic, environmental, or water quality data that may be needed to evaluate the application.

Pre-application meetings assist the applicant to submit a complete application. Information provided during a pre-application meeting is considered preliminary and not part of the formal application process and, thus, are not binding on the District. To receive the maximum benefit from the pre-application conference, the applicant should bring as much of the following information as they have to the meeting. It is not necessary to bring all of the following information, but the more specific the information at the start of the meeting, the more specific the results will be. Useful information includes:

- Geographic references such as section, township, range and parcel identification number;
- An overview map displaying the section, township, range and project location or parcel identification number and/or a detailed map (acceptable maps include tract maps, parcel maps, plats or similar construction drawings, or aerial photography at the plat-tract map scale);
- Aerial photograph at scale suitable for photo-interpretation of wetlands or other surface waters with ownership and project area outlined;
- The total land area, project area and land survey;
- Existing and proposed topography (grading) showing the existing and proposed flow patterns;
- The location of any onsite or adjacent wetlands and other surface waters;
- Wildlife survey, if appropriate;
- The location and details of the existing and proposed stormwater management system;
- A brief narrative describing the proposed construction activity;
- Construction drawings to illustrate the proposed activities;
- The history behind any existing permits that directly relate to the project or may be affected by the project;
- Differentiate between contiguous ownership and property served by proposed activity, and if single activity or phased construction;
- Location of impervious surfaces (i.e. buildings, parking areas, etc.), the amount of proposed impervious area and the amount of impervious area to be removed;
- Location of activities that may increase pollutant loading and adversely affect water quality (both surface and ground);
- Information on proposed stormwater management system design concepts such as: wet detention, dry retention, on-line, off-line, culverts, etc.;
- Soils information;
- FEMA flood hazard map, if in approximate area, how to establish an existing floodplain elevation;
- FEMA flood insurance study if a designated floodway is involved;
- Any existing or preliminary analyses (modeling);
- Erosion and sediment control plan;
- Operation and maintenance plan;
- Compliance or enforcement; and
- Bonding, letter of credit, or other type of surety requirements for as-built certifications.

To schedule a pre-application conference, applicants should follow the instructions provided on the District's website.

## 2.5 Professional Certification

All construction plans and supporting calculations submitted to the District for stormwater management systems that require the services of the registered professional must be signed, sealed, and dated by a registered professional.

## **2.6 Surveys**

All survey data to be submitted shall be signed and sealed by the appropriate registered professional. The survey shall include township, range and section, parcel information including parcel number and legal descriptions, temporary and permanent benchmarks, boundary information, topographic contours, all existing easements, setbacks, existing structures, FEMA flood zones with corresponding flood elevation information, location of water, sewer, reuse, gas and power lines, the location of all natural formations such as wetlands, sinkholes, ponds, lakes, creeks, and streams.

## **2.7 Computer Models**

The District does not have a specified list of computer models that must be used. Any model used must be able to provide the reasonable assurance that is required for issuance. District staff will use common models or if available the model the design professional used in order to review the results. If the model the design professional used is not available to the District reviewer, the results from available models must be similar.

## **2.8 Flexibility for State Transportation Projects and Facilities**

With regard to state linear transportation projects and facilities, the Agencies shall be governed by Section 373.413(6), F.S. (2012).

## **2.9 Redevelopments and Retrofits of Existing Stormwater Management Systems**

A stormwater retrofit project is typically proposed by a county, municipality, state agency, or water management district to provide new or additional treatment or attenuation capacity, or improved flood control to an existing stormwater management system or systems. Stormwater retrofit projects shall not be proposed or implemented for the purpose of providing the water quality treatment or flood control needed to serve new development or redevelopment. Examples of stormwater retrofit projects are:

1. Construction or alteration that will add additional treatment or attenuation capacity and capability to an existing stormwater management system;
2. Modification, reconstruction, or relocation of an existing stormwater management system or stormwater discharge facility;
3. Stabilization of eroding banks through measures such as adding attenuation capacity to reduce flow velocities, planting of sod or other vegetation, and installation of rip rap boulders;
4. Excavation or dredging of sediments or other pollutants that have accumulated as a result of stormwater runoff and stormwater discharges.

The applicant for a stormwater quality retrofit project must provide reasonable assurance that the retrofit project itself will, at a minimum provide additional water quality treatment such that there is a net reduction of the stormwater pollutant loading into receiving waters. Examples of stormwater quality projects are:

1. Addition of treatment capacity to an existing stormwater management system such that it reduces stormwater pollutant loadings to receiving waters;
2. Adding treatment or attenuation capability to an existing developed area when either the existing stormwater management system or the developed area has substandard stormwater treatment and attenuation capabilities, compared to what would be required for a new system requiring a permit under Part IV of Chapter 373, F.S.; or
3. Removing pollutants generated by, or resulting from, previous stormwater discharges.

If the applicant has conducted, and the Agency has approved, an analysis that provides reasonable assurance that the proposed stormwater quality retrofit will provide the intended pollutant load reduction from the existing system or systems, the project will be presumed to comply with the requirements in Section 4 of this Volume.

The pollutants of concern will be determined on a case-by-case basis during the permit application review based upon factors such as the type and intensity of land use, existing water quality data within the area subject to the retrofit, and the degree of impairment or water quality violations in the receiving waters.

The applicant for a stormwater quantity retrofit project must provide reasonable assurance that the retrofit project will reduce existing flooding problems in such a way that it does not cause a net reduction in water quality treatment

provided by the existing stormwater management system(s) or increased discharges of untreated stormwater entering adjacent or receiving waters.

If the applicant has conducted, and the Agency has approved, an analysis that provides reasonable assurance that the stormwater quantity retrofit project will comply with the above, the project will be presumed to comply with the requirements in Section 3 of this Volume.

The applicant for any stormwater retrofit project must design, implement, and operate the project so that it:

1. Will not cause or contribute to a water quality violation;
2. Does not reduce stormwater treatment capacity or increase discharges of untreated stormwater. Where existing ambient water quality does not meet water quality standards the applicant must demonstrate that the proposed activities will not cause or contribute to a water quality violation. If the proposed activities will contribute to the existing violation, measures shall be proposed that will provide a net improvement of the water quality in the receiving waters for those parameters that do not meet standards.
3. Does not cause any adverse water quality impacts in receiving waters; or
4. Will not cause or contribute to increased flooding of adjacent lands or cause new adverse water quantity impacts to receiving waters.

## **PART III – STORMWATER QUANTITY / FLOOD CONTROL**

### **3.1 General**

This document refers, in common engineering language, to flood and drought frequency impacts interchangeably with rainfall frequency. Additional calculations may be required to identify other combinations of site conditions and rainfall frequencies which might result in impacts of the specified frequency. Examples include designs affected by spring tides, fluctuating tides, and fluctuating receiving water stages.

An applicant for an ERP permit must provide mitigation for changes to water quantity such that these changes do not cause harm to individuals or water resources. The most widely used form of mitigation is the construction of stormwater management systems. Most systems are a combination of a retention and detention system. However, it is common practice to term a system exclusively retention or detention dependent upon its main function. Thus, a system whose volume is mostly in the form of retention would be called a retention system and likewise for a detention system.

These measures are not the only acceptable forms of mitigation. An applicant may wish to propose other alternatives, such as acquisition of flood rights or compensation for anticipated damages.

#### **3.1.1 Factors Influencing Water Quantity**

Water quantity can be measured in terms of volume and rate. The volume of runoff will be increased by any one of the following factors:

1. Vegetation removal;
2. Elimination of natural depressional storage;
3. Soil compaction;
4. Placement of impervious surfaces over pervious surfaces; or
5. Ditching.

The rate of runoff is a function of volume and time. The discharge rate increases if runoff volume is increased, by the factors listed above, and/or the time of concentration is decreased. The time of concentration decreases if a channelization effect is incurred, such as converting overland sheet flow to ditch flow or converting ditch flow to storm sewer flow. The net effect of these activities is to increase flow velocity, thereby decreasing time of concentration.

#### **3.1.2 Antecedent Moisture Condition**

AMC refers to the amount of moisture and storage in the soil profile prior to a storm event. Antecedent soil moisture is an indicator of wetness and availability of soil to infiltrate water. The AMC can vary from dry to saturated depending on the amount of rainfall received prior to a given point in time. Therefore, “average AMC” means the soil is neither dry nor saturated, but at an average moisture condition at the beginning of a storm event when calculating recovery times.

The antecedent condition has a significant effect on runoff rate, runoff volume, infiltration rate, and infiltration volume. The infiltration volume is also known as the upper soil zone storage. Both the infiltration rate and upper soil zone storage are used to calculate the recovery time of retention systems and must be estimated using any generally accepted and well documented method with appropriate parameters consistent with such generally accepted and well documented method to reflect drainage practices, SHWL, the AMC, and any underlying soil characteristics which would limit or prevent percolation of stormwater into the soil column.

### **3.2 Design Storms**

For projects which serve exclusively agricultural, forest, conservation, or recreational land uses, a design storm with a 10-year, 24-hour rainfall depth with SCS type II distribution falling on average antecedent moisture conditions shall be used. For projects which serve all other land uses, a design storm with 100-year critical duration rainfall depth with SCS type II distribution falling on average antecedent moisture conditions shall be used.

The District requires specific storm events to be analyzed in order to determine the storm of critical duration. The storm frequency (return period) is the probability that a storm depth would be equaled or exceeded in a given period of time. The relationship between design storm frequency and duration and rainfall distribution data is provided in Appendix B. The applicant shall analyze the 100-year frequency (one percent annual chance) analysis of the 1-, 2-, 4-, 8-, and 24-hour durations for all stormwater systems.

### **3.3 Discharge Rates and Volumes**

For projects which fall within an open basin, retention or detention systems may be utilized. In open basins, the post-development peak discharge rate must not exceed the pre-development peak discharge rate for any storm event. The discharge structure of the system shall be designed to provide for the release of water at rates similar to pre-development conditions for storm events up through and including the design storm.

For projects which fall within a closed basin, retention systems are the most effective. In closed basins, the post-development peak discharge rate and cumulative discharge volume must not exceed the pre-development peak discharge rate and cumulative discharge volume for all storm events. The discharge structure of the system shall be designed to provide for the release of water at rates similar to pre-development conditions for storm events up through and including the design storm. The required retention volume is the post-development runoff volume less the pre-development runoff volume for the 100-year critical event with a maximum duration of one day.

Where there are multiple off-site discharge locations or points of analysis, the post-development discharge shall not exceed the pre-development discharge at any single discharge location.

#### **3.3.1 Methodologies for Calculating Discharge**

There are several equations available for calculating discharge including, but not limited to, the Rational Method, Natural Resources Conservation Service (NRCS) method, and USGS regression equations.

A peak discharge analysis typically consists of generating pre-development and post-development runoff hydrographs, routing the post-development hydrograph through a detention or retention basin, and sizing an overflow structure to control post-development discharges at or below pre-development discharge. Acceptable design techniques also include the use of grassed waterways, and any other storage capability that the particular system may have.

Peak discharge computations shall consider the duration, frequency, and intensity of rainfall, the antecedent moisture conditions, upper soil zone and surface storage, time of concentration, tailwater conditions, changes in land use or land cover, and any other changes in topographic and hydrologic characteristics. Large systems should be divided into sub-basins according to artificial or natural drainage divides to allow for more accurate hydrologic simulations.

The Peak Rate Factor reflects the effect of watershed storage on the hydrograph shape and directly and significantly impacts the peak discharge value. As such,  $K'$  must be based on the true watershed storage of runoff, and not on the slope of the landscape which is more accurately accounted for in the time of concentration. However, the average slope of natural watersheds is highly interrelated with the surface storage potential. Land development will generally result in a reduction of natural storage. As a result, the  $K'$  value should either increase or remain constant, but never decrease. In most cases, post-development conditions will include detention storage areas; this storage should be accounted for by routing the hydrograph based on a defined stage-storage-discharge relationship and should therefore not be considered in determining  $K'$ . The most conservative approach is to use a  $K' = 484$  for post-development.

### **3.4 Recovery**

The stormwater management system shall recover as follows:

1. One-half of the total volume within seven days following the end of each design storm event, and
2. The total volume within 30 days following the end of each design storm event.

For retention systems, controlled discharge, percolation, and evaporation may be used to reduce storage volumes in the system. Since the stormwater must receive at least the minimum amount of water quality treatment before discharge, stormwater systems with a bleed down pipe or pipes at the bottom of the pond are not authorized. For detention systems with filtration, the design must accommodate a safety factor of two which can be accomplished by



increasing storage volumes, or reducing the percolation rates. Further, filters and filtration systems must have pore spaces large enough to provide a minimum permeability equal to or greater than the soil surrounding the filter. The filter medium must be stable and not move. If sand or other fine textured medium is used, it must meet the following characteristics:

1. Have less than one percent silt, clay, or organic matter unless filter fabric which will retain the fines is also used;
2. Have a uniformity coefficient of 1.5 or greater; and
3. Have an effective grain size of 0.20 to 0.55 millimeters in diameter.

These criteria are not intended to preclude the use of multilayered filters nor the use of additives to increase ion exchange, precipitation, or pollutant adsorption capacities of the filter.

In the event that a stormwater pond cannot meet the requirements above, the design professional may route back-to-back storms through the system. The system must be able to provide for required discharge rates and volumes.

#### **3.4.1 Percolation and Water Table**

Percolation outflow is a function of site-specific conditions such as soil density, particle size, degree of saturation, and water table. The recovery of the system depends on this information. Therefore, determining the percolation outflow is extremely important and can be very difficult. Percolation tests shall be performed or supervised by the appropriate registered professional. The location of soil borings and percolation test should be in the proposed location of the retention or detention pond. There shall be at least one boring per acre of the retention or detention pond. Borings should be spread out within the proposed area in order to obtain a reliable sampling.

Water table elevations will affect percolation rates. The design professional must consider seasonal high groundwater table (SHGWT) at the site to accurately determine percolation rates. Where the SHGWT is at different elevations within the proposed location of the detention or retention pond, the average of the highest and lowest SHGWT shall be used. SHGWT must be determined by on-site soil investigation by the appropriate registered professional.

Other information, such as, but not limited to, base of aquifer, fillable porosity, and horizontal conductivity shall also be provided by the appropriate registered professional. A soils report, which should include information from any documents about the soil such as the NRCS soil reports and any information found through testing of the specific soils, should be signed and sealed by the appropriate registered professional. Soil borings which support the determination are required.

#### **3.4.2 Mounding**

In addition to the water table, mounding will affect the percolation rate. For retention ponds, a computer model that incorporates a mounding analysis must be used. The mounding analysis is not required for detention ponds.

#### **3.5 Compensating Stormwater Treatment**

Applicants may find that it is impractical to construct a stormwater management system to capture the runoff from a portion of the project site as a result of on-site conditions such as extreme physical limitations, availability of right-of-way, or maintenance access. One method is to provide treatment for an off-site area which currently is not being treated (i.e., "off-site compensation"). Each method is designed to furnish the same level of treatment as if the runoff from the entire project site was captured and treated in accordance with the provisions of this Volume and Section 9 of Applicant's Handbook Volume I.

The applicant is strongly encouraged to schedule a pre-application conference with District staff to discuss the project if this alternative is being considered. Other rule criterion, such as peak discharge attenuation, will still have to be met if the applicant uses this method.

#### **3.6 Floodplain Delineation**

The District requires that the applicant's engineer will determine and provide the one percent annual chance of flood elevation as part of the required information for any development in or around areas subject to flooding.

This elevation should be determined using one of the following sources:

- Historical gaged data;
- Detailed flood study with a current, effective model;
- The latest effective Federal Emergency Management Agency (FEMA) flood insurance rate maps and flood insurance studies that have an established base flood elevation; or
- Calculations that are based on an acceptable hydrologic and hydraulic methodology.

Floodplain areas occur as static or dynamic systems. Static floodplain areas consist of runoff entrapped and held in surface bodies such as ponds, swamps, lakes, and topographical depressions. Outflow from a static floodplain area occurs through natural percolation and/or evapotranspiration. Dynamic floodplain (or floodway) areas occur in riverine systems.

### **3.6.1 Static Systems**

The floodplain elevation for a static system is determined using a flood routing calculation similar to the one used in design of a retention facility. If percolation is available, a critical duration analysis must be performed. The floodplain elevation will be the highest elevation calculated for the various durations. For some static systems such as large lakes and complex lake chain systems, it is extremely difficult if not impossible to perform an accurate analysis. For these situations, historical information should be sought from local residents or government officials.

### **3.6.2 Floodplain Storage and Conveyance**

A project may not:

1. Reduce existing surface water storage and conveyance capabilities;
2. Cause adverse water quantity impacts to receiving waters and adjacent lands;
3. Increase flood hazards outside the project area; or
4. Increase flood hazards that may affect the health, safety, and general welfare of persons residing within the project area.

There must be no net decrease in storage volume below the one percent annual chance of flood elevation within the project area which may result in increased flood hazards. The District will consider reductions due to filling, soil compaction, or covering with impervious surface in determining loss of storage and any increase in flood hazard. Floodways and floodplains, and levels of flood flows or velocities of adjacent streams, impoundments, or other water courses must not be altered so as to adversely impact the off-site storage and conveyance capabilities of the water resource. Buildings must be elevated on piles such that the lowest structural member of the first floor is a minimum of one foot above the 100-year flood elevation, or in the case of monolithic slab construction, the finished slab elevation shall be a minimum of one foot above the 100-year flood elevation.

### **3.6.3 Importer/Exporter (Site Storage Capacity)**

Project areas which import runoff before development must continue to do so after development. Project areas that export runoff prior to development may continue to do so. The post-development export of runoff must meet the appropriate rate and or volume criteria as well as approximate the type of export (for example, pre-development sheet flow exporting should be approximated in the post-development condition).

### **3.6.4 Compensating Storage**

Compensating storage may be used in order to accomplish no net increase in flood elevations. Compensating volumes shall be above the seasonal high groundwater table and shall, at a minimum, have a 1:1 ratio of volume provided to volume displaced. The volume below the maximum stage in the retention pond may not serve or contribute to the compensating volume.

### **3.6.5 Dynamic Systems**

Floodplain elevations for dynamic systems (floodways) can be calculated using a generally accepted hydrologic and

hydraulic modeling technique. This approach provides reliable data and is only superseded by historical gage information in accuracy.

### **3.6.6 “No-Rise” Requirements for Floodways**

For any obstruction placed within a floodway, including a Work of the District, a Florida licensed engineer shall certify that such structure will not obstruct flows or increase the one percent annual chance of flood elevations by more than 0.01 feet. Certification shall include step-backwater calculations using the one percent annual chance of flood discharge rate. A generalized method for determining “no-rise certification” may include the steps below. All model runs shall be in the floodplain (“without floodway”) conditions and shall include the following steps:

1. Obtain the current effective District model.
2. Run the current effective model. Your results must match that of the current effective model.
3. Add the pre-development cross sections of channel and overbank geometry (without proposed floodway encroachment). Run the model with pre-development cross sections. Your results must match that of the current effective model.
4. Run the model with the existing, permitted and proposed floodway encroachments.
5. The water surface profile obtained in number 4 (above) shall not exceed the water surface profile obtained in number 3 (above) by greater than 0.01 foot.

The engineer shall submit a report demonstrating a systematic analysis that provides evidence that the proposed project will produce no rise in flood profile or base flood elevations. The report should document an analytical process similar to the preceding method.

### **3.7 Determination of Tailwater Conditions**

The applicant must determine the design discharge rate, 100-year discharge rate, and corresponding tailwater elevations prior to selecting a culvert configuration. The tailwater elevations are the water surface elevations in the receiving watercourse at the culvert outlet corresponding to the discharge rates. The discharge rate is established using any acceptable hydrologic methodology. Typically, for small watersheds (i.e., less than 200 acres), the Rational Method is acceptable. For larger watersheds, a Regression Analysis as discussed above should be used. Generally, the NRCS methods should not be used since they may not produce a critical design situation. The District does not specify a design frequency to be used since the frequency may vary depending on specific site conditions and other constraints. However, the design frequency and corresponding hydraulic data must be provided in addition to analyzing the structure under 100-year frequency conditions.

The tailwater elevation for the design discharge rate can be obtained by computing the water profile corresponding to the design rate as discussed above. However, if a computer model is not employed, an approximation may be used by solving Manning’s equation using the design discharge rate and the friction slope corresponding to the 100-year profile and 10-year frequency.

If the project is bounded by natural watercourses, a water surface profile analysis, as discussed above, will automatically provide the tailwater elevation for the 100-year discharge rate. If the project area discharges to man-made ditches and channels with a uniform cross section and slope, the slope of the energy line is parallel to the water surface and channel bottom. Thus, the tailwater depth is determined using Manning’s equation and the physical slope of the channel bottom.

#### **3.7.1 Topographical Information**

Cross-sectional information is required for the reach of the system to be modeled. A minimum of four cross sections should be taken. In addition, all channel bends and constrictions should have cross sections. Cross sections should be taken perpendicular to the flow of the waterbody. The initial cross section should be located some distance downstream of the area to be modeled. The distance between successive cross sections must also be determined as depicted on page 20.

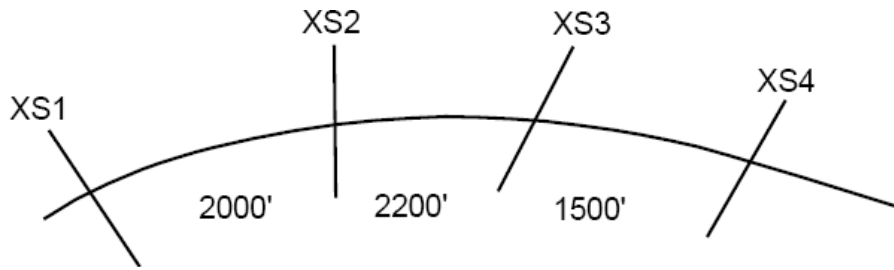

Cross sections should be taken from left to right looking downstream and proceed upstream. Required information includes beginning station and elevation with successive elevations and stations being recorded at each break not to exceed intervals of 200 feet. Manning’s “n” values should also be selected in the field and noted on the cross section. Manning’s “n” values should change to reflect differences in resistance to flow such as trees, limbs, brush, meandering channel, etc. A typical cross section with required field information is depicted in below:

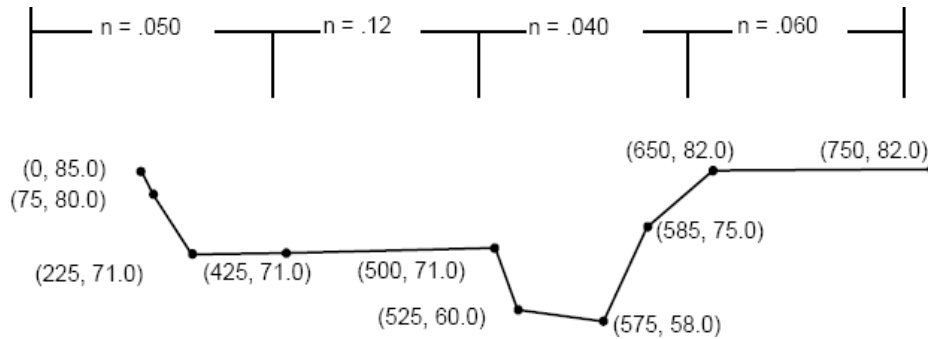

### 3.7.2 Surface Profile

Prior to calculating the water surface profile, the information outlined in the previous sections must be obtained. The next step is to calculate the boundary properties for each cross section at various elevations. The elevation interval selected should be commensurate with the accuracy desired. A minimum accuracy of one-foot elevations is required. Therefore, boundary properties should be determined at one-half foot increments. Required cross-sectional properties include area, wetted perimeter, and hydraulic radius. Once this data has been generated, the calculation of the water surface profile begins. The water surface elevation of successive cross sections is achieved by solving the one-dimensional energy equation as it applies to natural watercourses. The energy equation relationships are graphically depicted below:

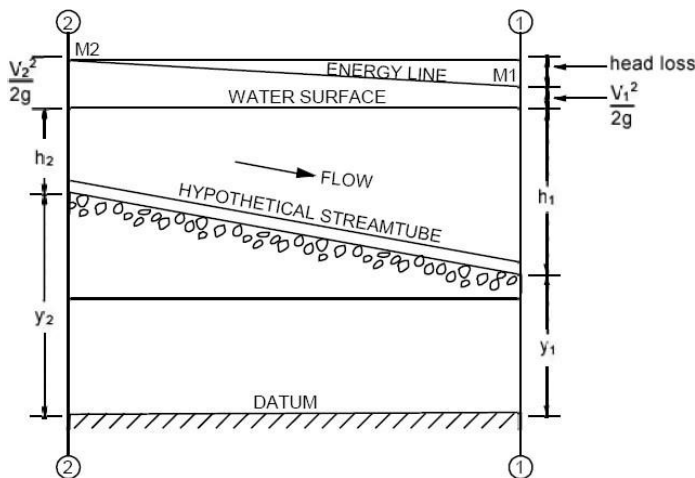

### 3.8 Low Flow and Base Flow Maintenance

Proposed systems shall not decrease the flows of adjacent streams, impoundments, or other watercourses below any minimum level or flow established by the District pursuant to Chapter 40B-8, F.A.C., or Section 373.042, F.S.

## **PART IV – ADDITIONAL STORMWATER QUALITY REQUIREMENTS**

### **4.1 General**

An applicant for an individual permit must provide mitigation for changes to water quality such that these changes do not cause harm to individuals or water resources. The most widely used form of mitigation is the construction of stormwater management systems. Most systems are a combination of a retention and detention system. However, it is common practice to define a system exclusively retention or detention dependent upon its main function. Thus, a system whose volume is mostly in the form of retention volume would be described as a retention system and likewise for a detention system.

All projects will be evaluated based on the ability of the system to prevent degradation of receiving waters and the ability to conform to State water quality standards as set forth in Applicant's Handbook Volume I.

#### **4.1.1 Factors Influencing Water Quality**

Water quality degradation can be attributed to the following activities:

- Placing impervious surfaces that no longer allow surface water to percolate and filter through permeable soils;
- Eliminating natural water quality enhancement systems such as wetlands;
- Increasing erosion potential and thereby sedimentation, from either vegetation removal and/or increased flow velocity; and
- Creating point-source pollutant generators such as vehicles, service stations, and industrial processes.

### **4.2 Dewatering**

A District water use permit may be required for dewatering that exceeds 180 days. If dewatering is required, it shall also be addressed in the review and issuance of the ERP. Dewatering plans shall be designed by a registered professional to meet State water quality standards as set forth in Applicant's Handbook Volume I.

### **4.3 State Water Quality Standards**

All stormwater management systems must be designed to provide minimum State water quality treatment requirements as set forth in Applicant's Handbook Volume I.

### **4.4 Recovery**

All stormwater management systems shall be designed to recover treatment volumes within 72 hours. For retention systems, only percolation and evaporation may be used to reduce storage and treatment volumes in the system. If detention with filtration is proposed, the design must accommodate a safety factor of two, which can be accomplished by increasing storage volumes, providing specified treatment volumes within 36 hours, or other means. It is recommended that the treatment volume is simulated as a slug load the computer model.

### **4.5 Erosion and Sediment Control**

The potential for soil erosion is greatly increased when development occurs. This higher potential is attributed to stripping of vegetation, land clearing activities, increased runoff volumes and rates, and concentration of surface runoff. The District requires that measures be taken to minimize soil erosion and sediment transport. The applicant shall submit an erosion and sediment control plan, as required in Applicant's Handbook Volume I, and follow the plan during construction of the stormwater system.

#### **4.5.1 Side Slopes**

Side slopes shall be designed with a horizontal to vertical ratio no steeper than 4:1 to a depth at least two feet below the control elevation and must be stabilized with vegetation to prevent erosion and provide pollutant removal. Side slopes may be designed with steeper than 4:1 side slopes provided the slopes have adequate erosion and sediment control BMPs in place during and after construction. Systems shall be fenced if the slopes must be steeper than 4:1

due to space limitations or other constraints.

## 4.6 Pollutant Control

### 4.6.1 Pre-Treatment

“Pre-treatment” is considered the treatment of a portion of the runoff prior to its entering the main stormwater management system, and is generally the beginning of a series of treatment methods, or a treatment train. Pre-treatment increases the pollutant removal efficiency of the overall stormwater system by reducing the pollutant loading to the stormwater management system. Pre-treatment may be used to enhance the appearance of the stormwater pond or meet the additional treatment criteria for discharges to receiving waters that are classified as OFWs or drain to a sinkhole.

For developments where the appearance of the stormwater pond is important, pre-treatment can reduce the chances of algal blooms and slow the eutrophication process. Some types of pre-treatment practices include utilizing vegetative swales for conveyance instead of curb and gutter, perimeter swales or berms around the lake, oil and grease skimmers on inlet structures, retention storage in swales with raised inlets, or shallow landscaped retention areas (when soils and water table conditions will allow for adequate percolation). Applicants who are unable to meet the stormwater treatment requirements set forth in Section 4 of Applicant’s Handbook Volume I using a single method shall include additional methods until the requirements are met.

### 4.6.2 Oil and Grease Control

Treatment of oils and greases shall be consistent with the requirements of Applicant’s Handbook Volume I. In addition to other methods, treatment may include the use of skimmers or baffles as described below:

#### Skimmer:

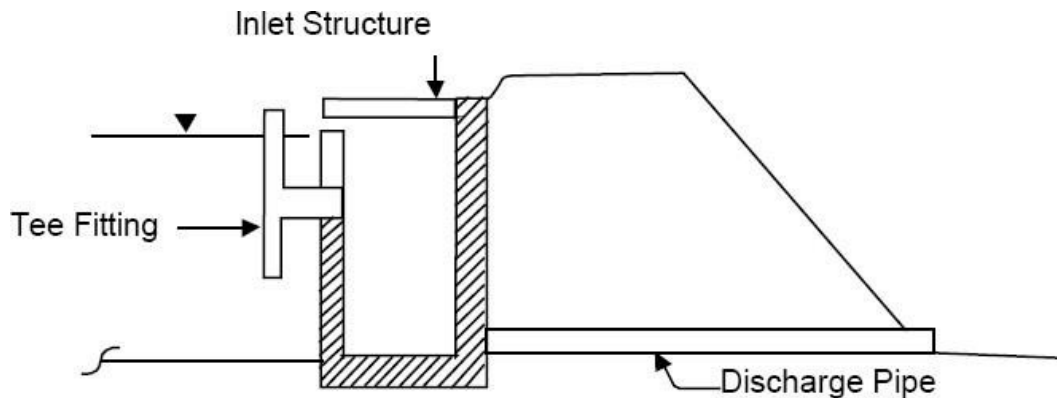

#### Baffle:

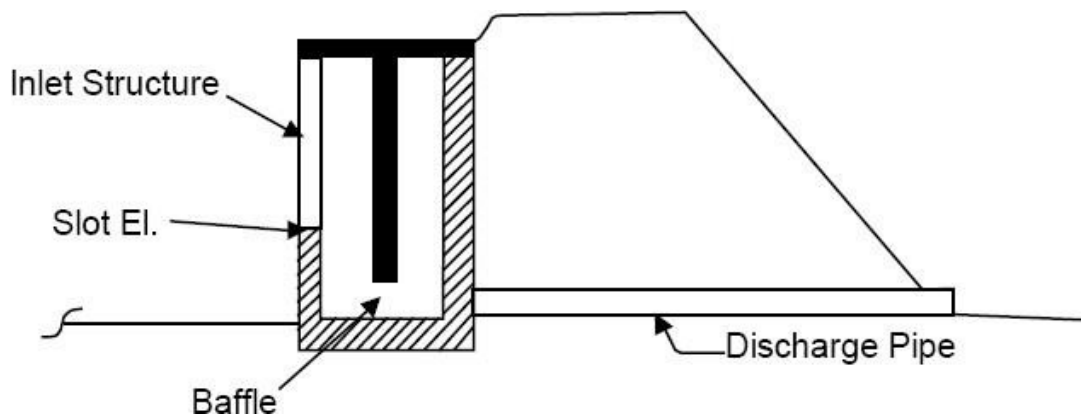

#### **4.7 Runoff Coefficients and Curve Numbers for Stormwater Systems**

Stormwater management ponds, including dry retention ponds, detention ponds with filtration, dry detention ponds with underdrains, and wet detention ponds, shall be considered as 100% impervious. The pond area, determined from the top of the pond, shall be calculated as directly connected impervious areas in composite runoff coefficients (c) and composite curve numbers (CN). Pervious pavement, pavers and other such surfaces shall use the runoff coefficient of the most impervious underlying material. Limerock, gravel, clay, and millings are semi-impervious materials.

## **PART V -- BEST MANAGEMENT PRACTICES**

The Best Management Practices (BMP)s below are the most frequently used BMPs in this District. The criteria listed below, and those contained in Applicant's Handbook Volume I, are those that, if followed, will result in reasonable assurance that the BMP will meet the conditions of issuance. An applicant may propose alternative designs to those provided in this section for consideration by the District. However, reasonable assurance in the form of plans, test results, or other information must be provided by the applicant to demonstrate that the alternative design meets the conditions for issuance in Rules 62-330.301 and 62- 330.302, F.A.C., and this Volume.

If a design professional wishes to use a BMP that is found in another WMD's Applicant's Handbook Volume II, the criteria found in their Applicant's Handbook Volume II may be used if converted to meet criteria for this District found in Parts II, III, and IV of this Volume. Applicants who are unable to meet the conditions of issuance using a single BMP shall include additional BMPs in a treatment train until the conditions are met.

### **5.1 Retention Pond Design Criteria and Guidelines**

#### **5.1.1 Description**

The term "retention system" is defined as a storage area designed to store a defined quantity of runoff, allowing it to percolate through permeable soils into the shallow groundwater aquifer. Stormwater retention works best using a variety of retention systems throughout the project site.

Soil permeability and water table conditions must be such that the retention system can percolate the desired runoff volume within a specified time following a storm event. After drawdown has been completed, the basin does not hold any water, thus the system is normally "dry." Unlike detention basins, the treatment volume for retention systems is not discharged to surface waters. Retention systems provide excellent removal of stormwater pollutants. Substantial amounts of suspended solids, oxygen demanding materials, heavy metals, bacteria, some varieties of pesticides and nutrients such as phosphorus are removed as runoff percolates through the vegetation and soil profile. Besides pollution control, retention systems can be utilized to promote the recharge of groundwater to prevent saltwater intrusion in coastal areas or to maintain groundwater levels in aquifer recharge areas. Retention systems can also be used to help meet the runoff volume criteria for systems that discharge to closed basins or land-locked lakes.

#### **5.1.2 Criteria**

Retention ponds shall comply with all applicable requirements of Parts II, III, and IV of this Volume, and Applicant's Handbook Volume I. The bottom of retention ponds is not required to be flat. The lowest elevation of the bottom of retention ponds shall be no less than one foot above the SHGWT. The retention pond shall have a minimum freeboard of one foot above the maximum stage in order to function properly during storms greater than the design storm. Retention ponds shall be equipped with an emergency discharge system designed to pass runoff resulting from storm events larger than the design storm. Overflow structures shall be designed such that the top of the structure is below the top of the pond and above the maximum stage. Retention ponds with berms greater than five feet from the top of the berm to the lowest natural ground elevation shall comply with Section 5.8 of this Volume. The retention basin shall be stabilized with pervious material or permanent vegetative cover. The system shall not cause adverse secondary impacts to adjacent wetlands or other surface waters. The flow path of water from the inlets to the outlet should be maximized to ensure treatment. If short flow paths are unavoidable, the effective flow path can be increased by adding diversion barriers such as islands, peninsulas, or baffles to the pond. Inlet and outlet structures shall be designed to dissipate the energy of water entering and exiting the pond.

### **5.2 Dry Detention Pond Design Criteria and Guidelines**

Dry detention is typically used to meet stormwater quantity requirements, and additional stormwater treatment systems may be required to comply with the requirements of this Volume, and Applicant's Handbook Volume I. Additional treatment may include a media filter, surface discharge filter, or exfiltration trench.

#### **5.2.1 Description**

Water discharged from the system must be treated, therefore, detention ponds cannot be designed to simply have a bleed down pipe at the pond bottom. The system must provide water quality treatment through underdrains, sidedrains, vertical volume recovery systems or other type systems. For the purposes of this section, water quality treatment



system (WQTS) shall refer to underdrains, sidedrains, vertical volume recovery systems and other such systems. Detention ponds are an option for the applicant where high groundwater table conditions dictate that recovery of the stormwater treatment volume cannot be achieved by natural percolation and suitable outfall conditions exist to convey flows from the detention pond to receiving waters. These systems are intended to provide for the drawdown of the treatment volume. WQTS are utilized to treat the stormwater through sand or other adequate media in order to meet state water quality standards of Applicant's Handbook Volume I.

### **5.2.2 Criteria**

Dry Detention ponds shall comply with all applicable requirements of Part II, III, and IV of this Volume, and Applicant's Handbook Volume I. The bottom of detention ponds is not required to be flat. The detention pond shall have a minimum freeboard of one foot above the maximum stage for storms greater than the design storm. Dry detention ponds shall be equipped with an emergency discharge system designed to pass runoff resulting from storm events larger than the design storm. Overflow structures shall be designed such that the top of the structure is below the top of the pond and above the maximum stage. Dry Detention ponds with berms greater than five feet from the top of the berm to the lowest natural ground elevation shall comply with Section 5.8 of this Volume. Storage volumes in detention ponds shall be calculated so as not to include any volumes below the SHGWT. The system shall not cause adverse secondary impacts to adjacent wetlands or other surface waters. 48 hours prior to the construction of the WQTS, the District shall be notified and District staff shall be present during the installation. The flow path of water from the inlets to the outlet should be maximized to ensure treatment. If short flow paths are unavoidable, the effective flow path can be increased by adding diversion barriers such as islands, peninsulas, or baffles to the pond. Inlet and outlet structures shall be designed to dissipate the energy of water entering the pond.

WQTS in a detention pond may consist of a perforated drainage pipe which collects and conveys water following percolation from the basin through suitable soil media. The pipe system configuration (e.g., pipe size, depth, pipe spacing, and pipe inflow capacity) of the system must be designed to achieve the recovery time requirement. The WQTS shall utilize filter fabric or other means to prevent the soil from moving into the gravel envelope, if proposed. The WQTS shall provide capped and sealed inspection and cleanout ports which extend to the surface of the ground. The inspection and cleanout ports shall be located at the inlet and terminus of the system, and at a minimum, every 400 feet and every bend of 45 or more degrees. The perforated pipe shall be designed with a 12-inch minimum inside pipe diameter and a three-foot minimum trench width. The perforated pipe shall be located within the trench section to minimize the accumulation of sediment in the aggregate void storage and maximize the preservation of this storage for stormwater treatment. It is recommended that the perforated pipe be located at or within six inches of the trench bottom.

## **5.3 Exfiltration Trench Systems Design Criteria and Guidelines**

### **5.3.1 Description**

An exfiltration trench is a subsurface system consisting of a conduit such as perforated pipe surrounded by natural or artificial aggregate which temporarily stores and infiltrates stormwater runoff. Stormwater passes through the perforated pipe and infiltrates through the trench walls and bottom into the ground. These types of system are commonly referred to as underground vaults or underground storage units. Operation and maintenance are of great concern as sediment accumulation and clogging by fine sediment can reduce the life of the system.

### **5.3.2 Criteria**

Exfiltration trench systems shall comply with all applicable requirements of Parts II, III, and IV of this Volume, and Applicant's Handbook Volume I. The bottom of an exfiltration trench is required to be level. The trench system shall have a minimum freeboard of one foot above the maximum stage up to land surface in order to function properly during storms greater than the design storm. The trench system shall not cause adverse secondary impacts to adjacent wetlands or other surface waters. The inspection and cleanout ports shall be located at the inlet and terminus of the system, and at a minimum, every 400 feet and every bend of 45 or more degrees. Standard precast concrete inlets and manholes may be used for inspection and cleanout access. Inlet structures shall include sediment sumps. 48 hours prior to the construction of the WQTS, the District shall be notified and District staff shall be present during the installation. Exfiltration trench systems shall be designed so that aggregate in the trench is enclosed in filter fabric. Filter fabric may also be utilized directly surrounding the perforated pipe. The exfiltration trench system shall be designed so that the invert elevation of the trench is at or above the seasonal high groundwater table elevation.

## **5.4 Wet Detention Pond Design Criteria and Guidelines**

### **5.4.1 Description**

Wet detention systems are permanently wet ponds which are designed to slowly release collected stormwater runoff through an outlet structure. Wet detention systems are the recommended BMP for sites with moderate to high groundwater table conditions. Wet detention treatment systems provide significant removal of both dissolved and suspended pollutants by taking advantage of physical, chemical, and biological processes within the pond. Wet detention systems offer an effective alternative for the long-term control of water levels in the pond, provide a predictable recovery of storage volumes within the pond, and are easily maintained by the maintenance entity. In addition to providing good removal of pollutants from runoff, wet detention systems also provide other benefits such as flood detention, passive recreational activities adjacent to ponds, storage of runoff for irrigation, and pleasing aesthetics. As stormwater treatment systems, these ponds should not be designed to promote in-water recreation (i.e., swimming, fishing, and boating).

### **5.4.2 Criteria**

Wet detention ponds shall comply with all applicable requirements of Parts II, III, and IV of this Volume, and Applicant's Handbook Volume I. The control elevation shall be set at or above the SHGWT and at or above the design tailwater elevation. The bottom of wet detention ponds is not required to be flat. The detention pond shall have a minimum freeboard of one foot above the maximum stage in order to function properly during storms greater than the design storm. Wet detention ponds shall be equipped with an emergency discharge system designed to pass runoff resulting from storm events larger than the design storm. Overflow structures shall be designed such that the top of the structure is below the top of the pond and above the maximum stage. Wet detention ponds with berms greater than five feet from the top of the berm to the lowest natural ground elevation shall comply with Section 5.8 of this Volume. Storage volumes in detention ponds shall be calculated so as not to include any volumes below the SHGWT. The system shall not cause adverse secondary impacts to adjacent wetlands or other surface waters. The pond must be designed so that the pond side slopes are no steeper than 4H:1V (horizontal:vertical). Drawdown devices with a width smaller than three inches shall include a device to eliminate clogging. The flow path of water from the inlets to the outlet should be maximized to ensure treatment. If short flow paths are unavoidable, the effective flow path can be increased by adding diversion barriers such as islands, peninsulas, or baffles to the pond. Inlet and outlet structures shall be designed to dissipate the energy of water entering and exiting the pond. A dewatering plan, if required, shall be the minimum plan required to provide reasonable assurance that water discharged for the site will meet state water quality standards. If the contractor discovers the plan is ineffective, the contractor shall design and implement an effective adaptive management plan.

### **5.4.3 Permanent Pool**

The permanent pool shall be sized to provide at least a 14-day residence time based upon average wet season rainfall (rainfall occurring over the wettest four months of an average year). Additional permanent pool volume is required for wet detention systems which directly discharge to OFWs. The maximum depth of the permanent pool shall be 12 feet. The minimum depth of the permanent pool shall be two feet. An aerobic environment should be maintained throughout the water column in wet detention ponds.

## **5.5 Swale System Design Criteria and Guidelines**

### **5.5.1 Description**

Swales are a man-made or natural system shaped or graded to required dimensions and designed for the conveyance and rapid infiltration of stormwater runoff. Swales are designed to infiltrate a defined quantity of runoff through the permeable soils of the swale floor and side slopes into the shallow groundwater aquifer. Turf is established to promote infiltration and stabilize the side slopes. The swale holds water only during and immediately after a storm event, thus the system is normally "dry." Swales provide excellent removal of stormwater pollutants. Substantial amounts of suspended solids, oxygen demanding materials, heavy metals, bacteria, some varieties of pesticides and nutrients such as phosphorus are removed as runoff percolates through the vegetation and soil profile. Besides pollution control, swale systems can be utilized to promote the recharge of groundwater to prevent saltwater intrusion in coastal areas, and to maintain groundwater levels in aquifer recharge areas. Swales can be incorporated into the design of a stormwater management system to help meet the runoff volume criteria.

## **5.5.2 Criteria**

Swale systems shall comply with all applicable requirements of Parts II, III, and IV of this Volume, and Applicant's Handbook Volume I. Swales may be designed as linear retention basins or for conveyance. Swales shall have side slopes no steeper than or equal to 3:1 (horizontal to vertical). Construction of swale systems must be in conformance with procedures that avoid degradation of swale infiltration capacity due to compaction and construction sedimentation. Swales shall be stabilized with vegetative cover suitable for soil stabilization, stormwater treatment, and nutrient uptake. The swale shall be designed to take into account the soil erodibility, soil percolation, slope, slope length, and drainage area so as to prevent erosion and reduce pollutant concentrations.

## **5.6 Vegetated Natural Buffers Design Criteria and Guidelines**

### **5.6.1 Description**

Vegetated natural buffers (VNB) are defined as naturally vegetated areas that are set aside between developed areas and a receiving water or wetland for stormwater treatment purposes. Under certain conditions, VNBs are an effective best management practice for the control of nonpoint source pollutants in overland flow by providing opportunities for filtration, deposition, infiltration, absorption, adsorption, decomposition, and volatilization. VNBs are most commonly used as an alternative to swales or berms installed between back-lots and the receiving water. Buffers are intended for use to avoid the difficulties associated with the construction and maintenance of backyard swales controlled by individual homeowners. Potential impacts to adjacent wetlands and upland natural areas are reduced because fill is not required to establish grades that direct stormwater flow from the back of the lot towards the front for collection in the primary stormwater management system. In addition, impacts are potentially reduced since buffer strips can serve as wildlife corridors, reduce noise, and reduce the potential for siltation into receiving waters. Vegetative natural buffers are not intended to be the primary stormwater management system for residential developments. They are most commonly used only to treat those rear-lot portions of the development that cannot be feasibly routed to the system serving the roads and fronts of lots.

### **5.6.2 Criteria**

Vegetated natural buffers shall comply with all applicable requirements of Part II, III, and IV of this Volume, and Applicant's Handbook Volume I. The use of a VNB for other types of development shall only be allowed if the applicant demonstrates that there are no practical alternatives for those portions of the project. The existing vegetation must not be disturbed during the development of the project. In all cases, a minimum buffer width of 25 feet is required to ensure the integrity of the treatment system. To promote overland flow, the maximum width (dimension parallel to the flow direction) of the contributing area is 300 feet. The contributing area must be stabilized with permanent vegetative cover. No fertilizer shall be applied to the contributing area. Erosion control measures must be utilized during development of the contributing area so as to prevent siltation of the buffer area.

For systems that discharge to receiving water bodies other than OFWs, the VNB must be designed to provide at least 200 seconds of travel time by overland flow through the buffer for the 2-year, 24-hour storm event. Systems which directly discharge to OFWs must be designed to provide at least 300 seconds of travel time by overland flow through the buffer for the 2-year, 24-hour storm event. The maximum slope of VNB must not be greater than 15%. The length of the buffer (measured perpendicular to the runoff flow direction) must be at least as long as the length of the contributing runoff area. Runoff from the adjacent contributing area must be evenly distributed across the buffer strip to promote overland flow.

A legal reservation, in the form of an easement or other limitation of use, must be recorded which provides preservation of the existing undeveloped area in its natural state. The reservation must also include access for maintenance of the VNB unless the operation and maintenance entity wholly owns or retains ownership of the property. The legal reservation must include at least the entire area of the VNB.

## **5.7 Borrow Pits and Ponds Design Criteria and Guidelines**

### **5.7.1 Description**

Borrow pits are defined in Part II of Volume I. Borrow pits typically do not hold water for extended periods of time. Ponds may be defined as a body of standing water either natural or man-made, which is usually smaller than a lake. Some ponds are created specifically for habitat restoration or water treatment. Others are designed for aesthetic ornamentation as landscape or architectural features.

### **5.7.2 Criteria**

Borrow Pits and ponds shall comply with all applicable requirements of Parts II, III, and IV of this Volume. The materials to be excavated from borrow pits must be homogenous, and grading or sorting of the materials shall not occur. Materials removed from borrow pits or ponds may be used on site or may be removed from the site. Borrow pits may be filled in after completion of construction with clean material that does not include oils, greases, construction debris, household trash, or hazardous materials or waste. Ponds may have natural liners such as compacted clay or limerock or manmade material such as impermeable liners. Applicants proposing borrow pit excavations extending below the water table shall include a dewatering plan that contains, at a minimum, the following:

1. Assurances that water discharged from the site will meet state water quality standards;
2. Assurances that rim ditches will remain hydrated while dewatering in proximity to wetlands; and
3. An adaptive management plan that will be followed if the proposed dewatering plan is ineffective.

Borrow pits and ponds with berms greater than five feet from the top of the berm to the lowest natural ground elevation shall comply with Section 5.8 of this Volume. The overflow structure of the pond shall be below the top of the pond. An overflow system shall be designed such that it can pass a storm greater than the design storm without damage. The registered professional shall calculate the normal water level and 100-year flood elevation of the pond.

Borrow pits shall have at least one boring per two acres spatially arranged throughout the area of the proposed borrow pit. The underlying geology of the site and a subsurface cross section of the project site shall be determined and mapped. Documents shall provide reasonable assurance that the underlying aquifer will not be disturbed. Restoration plans should include detailed descriptions of all vegetative restoration efforts, stem densities of trees to be planted, species of grass to be sown, monitoring efforts and bank stabilization techniques. A survey shall be provided that determines the number and location of active gopher tortoise burrows or historical artifacts. The applicant shall provide an erosion and sediment control plan that provides reasonable assurance that the borrow pit will not erode and encroach on adjacent landowners. Waters diverted around the pit shall be discharged in the same general direction and pre-construction rate. A dewatering plan, if required, shall be the minimum plan required to provide reasonable assurance that water discharged for the site will meet state water quality standards. If the contractor discovers the plan is ineffective, the contractor shall design and implement a plan that is effective.

## **5.8 Dams and Impoundments Design Criteria and Guidelines**

### **5.8.1 Description**

Dams and Impoundments are both defined in Part II of Volume I. Dams and impoundments are classified as follows:

- **Low Hazard Potential**  
Dams assigned as low hazard potential are those where failure or mis-operation is not expected to result in loss of human life and may result in low economic and/or environmental losses, that are largely limited to the owner's property.
- **Significant Hazard Potential**  
Dams assigned as significant hazard potential are those where failure or mis-operation would not be expected to probably result in loss of human life, but can cause economic loss, environmental damage, disruption of lifeline facilities, or impact other concerns, such as water quality.
- **High Hazard Potential**  
Dams assigned as high hazard potential are those where failure or mis-operation of the dam will probably cause

the loss of human life. Economic, environmental, and lifeline losses may also occur, but they are not necessary for this classification.

### 5.8.2 Criteria

Dams and impoundments shall comply with all applicable requirements of Parts II, III, and IV of this Volume, and Applicant's Handbook Volume I. The discharge capacity and/or storage capacity must be capable of safely handling the following spillway design floods. Low hazard dams, less than 25 feet in height, shall safely handle the 100-year critical duration rainfall event. All other dams shall safely handle the Probable Maximum Precipitation (PMP). The PMP for the district is 31 inches for a period over a 200-square mile drainage area. This precipitation must be increased by a multiplier of 1.23 for 10-square mile drainage basins and 1.05 for 100-square mile drainage basins. The PMP in design serves to eliminate the possibility of the addition of sudden structural failure to already serious flood conditions. The design height of an earth embankment must be sufficient to contain or control the most restrictive of the following situations, acting singularly or in combination:

1. Peak water elevation in the reservoir or pond area;
2. Wave run-up above the peak water elevation;
3. Hydraulic head to achieve minimum, emergency spillway discharge;
4. Anticipated soil consolidation and settlement in the embankment soil mass and foundation zone; plus
5. An additional amount as a factor of safety based upon the accuracy and precision of the data and calculations used to determine any of these conditions.

The elevation difference between the maximum height of the earth embankment and the normal water level in the reservoir or pond is called freeboard. Freeboard shall be called out on the construction plans.

### 5.8.3 Embankment Slope Stability

The applicant's engineer shall analyze the stability of embankment slopes using generally accepted methods based on sound engineering principles and document all analyses or considerations in appropriate design reports and files. The design professional must design and provide documentation that the embankment has adequate factors of safety and will not fail due to the below general failure modes:

- **Overtopping**, where the quantity of floodwater entering the system is greater than its capacity and water pours over the top of the embankment. Embankment failure results from erosion on the backside of the berm caused by water cascading over the crown and gradually washing soil away until the full cross section is breached. Embankments constructed of clay soil can withstand significantly more overtopping than berm constructed of silt or sandy soil.
- **Seepage and Piping**, where floodwater seeps through or under an embankment and carries the embankment or foundation material with it. Some seepage through an earthen embankment is relatively common, but when the seepage finds or creates a drainage path, or "pipe," through erodible material, such as a sand strata, material is gradually washed out through a "boil" on the landside of the embankment. If unchecked, sufficient material can exit the embankment through the boil to create a large void inside the embankment, resulting in a depression or "slump" in the crown of the berm. If the crown slumps below the water surface elevation, overtopping will occur through the depression and lead to failure.
- **Erosion**, where high water velocity or wave action removes material from the embankment or the stream bank adjacent to the embankment, leading to slope instability and increased seepage.
- **Sliding (Rotational Slip)**, where seepage through the embankment, or even through saturation caused by extensive duration of high water, weakens the embankment and/or foundation material to the point where the weight of soil exceeds its internal strength. The embankment slope then slides. This type of sliding is a characteristic problem for embankments built of clay soil.
- **Sloughing**, where seepage through the embankment causes the outermost soil on the berm slope to slide down. Progressive sloughing shortens the seepage path through the embankment, causing increasingly heavy seepage until the embankment gives way. Sloughing is a characteristic problem of silty and sandy berms.

### 5.8.4 Construction Standards

Design:

1. Site Investigation – The general area for use as a settling area shall be carefully inspected by the design engineer prior to selection of the exact location for a dam. Areas of uneven natural subsidence, sinkhole, pockets of organic matter, or other unstable soils shall be avoided, unless special provisions are made for their correction.
2. Soil Testing – A program of soil sampling and testing adequate to determine the characteristics of the foundation material which will support the proposed dam shall be performed. Sampling shall include borings and/or in-place samples from the exposed excavation face. All borings shall be logged using a recognized engineering soil classification system (such as Unified System) with location and depths of samples recorded on the log. Tests including but not limited to, the determination of in-placed densities, shear-strength, and permeabilities of the foundation and embankment soils shall be performed on either undisturbed samples or on the in-place soil. Tests on embankment soils shall be performed on samples remolded to the densities to be used in construction. All soil test data used for design shall be derived from tests performed in compliance with the American Society of Testing Materials, American Association of State Highway Officials, or U. S. Army Corps of Engineers soil testing specifications and procedures.
3. Cross Section Design – The design height of an earth embankment should be sufficient to prevent overtopping during passage of the design storm event plus the freeboard required for wave action. The design height must also meet the requirements for minimum emergency spillway depth. The design shall provide positive seepage control features, such as, but not limited to:
  - Cut-off trench in natural soil foundations;
  - Clay core;
  - Blanket drain; and
  - Chimney drain and toe drain.
4. Stability Analysis – The embankment and foundation are to be analyzed for stability against failures found in Section 5.8.3. The appraisal of stability is to be based on the comparative performance of similar embankments and a slope stability analysis using engineering judgment. Settlement, seepage, and cracking are to be considered and adequate measures included to control or safely compensate for their effects. Analyses are to be made for the conditions or periods during the design life which are the most critical or severe. These conditions will be for various moisture and loading conditions of the embankment and foundation. These are to include the following conditions:
  - Immediately after construction;
  - During full reservoir steady seepage; and
  - During partial or complete sudden drawdown.

In each case, the analysis shall be made using engineering property values determined by laboratory tests simulating the assumed condition. Soil mechanics data used may be from specific testing for the site or by documented reference to data which can be correlated. The method of slope stability analysis used shall be appropriate for the loading condition and location and shape of potential failure surface. The embankment and foundation conditions shall be determined to a degree consistent with the complexity of the site and the potential for failure. The adequacy of the geologic and soil investigation, along with the significance of minor variations, shall be evaluated in the stability, seepage, and settlement analyses. Seepage control shall be added to all penetrations of the earth embankment as may be required to ensure containment and control of the impounded waters or stability of the soil mass.

5. Design Safety Factors – The design engineer shall use generally accepted minimum safety factors. Site Preparation – Ground which will become the foundation of earth dams shall be stripped of all vegetation and organic detritus or residue, including muck, mud, slimes, or other material which would flow or undergo excessive consolidation under heavy loading. All earth foundation surfaces on which fill is to be placed shall be scarified or moistened and compacted prior to spreading of first course fill material, and the dam base shall be well drained during construction, except when placing hydraulic fill.

#### Material to be Used:

Material used for earthen dams shall be free of stumps, vegetation, trees, palmettos, muck, and other extraneous matter which could affect the compactability, density, permeability, or shear strength of the finished dam. Tailings may be used for dam fill as approved by the District.

### Water Level Control:

Sufficient water level control structures shall be installed in the impoundment area behind an earthen dam to maintain the minimum required freeboard and to accommodate the release of stormwater resulting from heavy rainfall.

### Methods of Construction:

1. Each new dam shall be constructed to meet or exceed the minimum safety requirements of the specifications and design for that dam. Draglines, drag scrapers, tractor, or other appropriate earth moving equipment shall be used to place materials used in dam construction. Materials used in rolled dams shall be blended prior to compaction. The soil shall be compacted and density tests shall be performed to ensure that the designed densities are obtained. A qualified representative of the design engineer shall be present on the site each working day during construction of a rolled dam to ensure that materials and construction methods meet all specifications of the design. The District engineer shall be advised of the date on which construction or shaping of a new dam will begin so that they can inspect the site.
2. Areas around any water level control structure pipe, any other conduit, or any surface of discontinuity between materials within the mass of the dam shall be carefully installed to avoid potential concentration of seepages. All conduits through dams shall have two or more seepage collars spaced in accordance with good engineering practices pertinent to the material used for the fill. Two collars shall be installed within the core when there is core within a dam. All pipes and joints in pipes extending through a dam shall be made leak-proof and shall be constructed of material suitable for the fluids carried and load imposed. In order to avoid leaks associated with differential settlement, conduits through dams shall not be rigidly supported by piles or piers. Backfill around conduits shall be of a density that is equal to or greater than those of the surrounding embankment. Particular attention shall be devoted to the lower third of the conduit.

### Documentation:

The owner of an earthen dam should maintain in a permanent file the following construction records pertaining to the dam:

- Aerial photo of construction site.
- Design drawings and calculations.
- Design specifications.
- Results of all soil tests on foundations and fill materials.
- Logs of borings and engineering geology reports.
- Certified copies of construction progress inspections pertinent to core trench, toe drain, internal drains, and other significant phases of the structure. Photographs of various structural items may be included in the file.
- Description of and justification for all deviations or variances from the design plans or specifications.

### Inspections:

Personnel or agents of the District may accompany inspectors on any routine inspection required by the District, or inspect settling areas at any other time which is reasonable under the circumstances involved. They may also examine any routine inspection reports and be furnished copies thereof upon request.

#### **5.8.5 Principle Spillways**

The structural design and detailing of principal spillways are to conform to the recommendations of National Engineering Handbook, Section 6, "Structural Design" and NRCS standard drawings. All component parts such as gates and trash racks are to be equally durable. The required capacity of the principal spillway depends on:

- The purpose of the dam;
- The amount of storage provided by the retarding pool;
- The kind of emergency spillway;
- Stream channel capacity and stability downstream;
- Potential damage from prolonged storage in the retarding pool;

- Potential damage downstream from prolonged high outflow rates;
- The possibility of substantial runoff from two or more storms in the time required to empty the retarding pool;
- Limitations imposed by water rights or other legal requirements;
- Environmental concerns;
- Planned or potential alterations of the channel downstream; and
- The necessity to pass base and flood flows during construction.

A controlled spillway must be provided that will effectively drain the impoundment unless otherwise approved by the District.

### **5.8.6 Emergency Spillways**

Emergency spillways are provided to convey excess water through, over, or around a dam. They are usually open channels excavated in natural earth, earth fill, rock, or constructed of reinforced concrete. Emergency spillways are to be proportioned so they will pass the emergency spillway hydrograph at the safe velocity determined for the site. They are to have sufficient capacity to pass the freeboard hydrograph with the water surface in the reservoir at or below the elevation of the design top of the dam.

### **5.8.7 Reservoir Regulation**

A reservoir regulation plan should be developed so that regulating the reservoir and discharges under normal and emergency conditions are designed to assure that they do not constitute a danger to the safety of the dam or the human life or property downstream.

## **5.9 Sensitive Karst Area Design Criteria and Guidelines**

### **5.9.1 Background of the Sensitive Karst Areas**

The Floridan Aquifer System is the drinking water source for most of the population in the geographical extent of the district. Where the limestone or dolostone that comprises the Floridan Aquifer System is at or near the land surface, the District has designated these areas as a Sensitive Karst Area (SKA). Sediments overlying the limestone can be highly permeable and the limestone or dolostone, due to its chemical composition, is susceptible to dissolution when it interacts with slightly acidic water. “Karst” is a geologic term used to describe areas where landscapes have been affected by the dissolution of limestone or dolostone, including areas where the formation of sinkholes is relatively common. Sensitive Karst Areas are areas with hydrogeological and geologic characteristics relatively more conducive to potential contamination of the Floridan Aquifer System from surface pollutant sources. The formation of karst-related features, such as sinkholes is also more likely to occur in SKAs.

### **5.9.2 Hydrogeology of the Sensitive Karst Areas**

Throughout the majority of the geographical extent of the district the highly porous limestone that comprises the Floridan Aquifer System can be overlain by tens to hundreds of feet of sands, clays, and other material. Where present, this material may act to protect, to varying degrees, the Floridan Aquifer System from surface pollutants. Surface water seeps through this material slowly, which allows for some degree of filtration, adsorption, and biological transformation or degradation of contaminants. In SKAs, however, the limestone that comprises the Floridan Aquifer System may occur at or near the land surface and sand overburden, confining clays, or other confining cover material is absent or discontinuous. As a result, there can be rapid movement of surface water and possibly entrained contaminants into the aquifer. The SKAs are areas of relatively high recharge to the Floridan Aquifer System. Floridan Aquifer System groundwater levels vary from land surface to approximately 290 feet below land surface in the SKAs.

One factor that makes the SKAs particularly prone to stormwater contamination is the formation of solution pipe sinkholes within retention basins. Solution pipe sinkholes are common in these areas and form due to the collapse of surficial material into vertical cavities that have been dissolved in the upper part of the limestone. They are also formed by the movement of surface material into the underlying porous limestone. In most cases, the solution pipes are capped by a natural plug of sands and clays. If the cap is washed out (as may happen if a large volume of water is stored over the solution pipes), the resulting solution pipe sinkhole can act as a direct pathway for the movement of surface water into the Floridan Aquifer System. Solution pipe sinkholes and other types of sinkholes may open in the bottom of



stormwater retention basins. The capping plug or sediment fill may be reduced by excavation of the basin. Stormwater in the basin may increase the hydraulic head on the remaining material in the pipe throat. Both of these factors can wash material down the solution pipe. Solution pipes act as natural drainage wells and can drain stormwater basins. The irregular weathering of the limestone surface in the SKAs contributes to uncertainty and errors in predicting the depth from land surface to the limestone.

### **5.9.3 Design Criteria for Sensitive Karst Areas**

In addition to the design criteria for projects outside of the SKAs, projects located within the SKAs also must meet these additional design criteria:

Stormwater management systems shall be designed and constructed to prevent direct discharge of untreated stormwater into the Floridan Aquifer System. Such stormwater management systems also shall be designed and constructed in a manner that avoids breaching an aquitard and such that construction excavation will not allow direct mixing of untreated water between surface waters and the Floridan Aquifer System. The system shall also be designed to prevent the formation of solution pipes or other types of karst features in the SKAs. Test borings located within the footprint of a proposed stormwater management pond must be plugged in a manner to prevent mixing of surface and groundwater.

There shall be a minimum of three feet of unconsolidated soil material between the surface of the limestone bedrock and the complete extent of the bottom and sides of the stormwater basin at final completion of the project. Excavation and backfill of unconsolidated sediment or soil material shall be conducted, if necessary to meet these criteria. This provision is presumed to provide reasonable assurance of adequate treatment of stormwater before it enters the Floridan Aquifer System.

To reduce the potential for solution pipe sinkhole formation caused by newly created additional hydraulic head conditions, stormwater storage areas are limited to a maximum of 10 feet of vertical staging (shallower depths are encouraged), as measured for dry ponds from the bottom of the pond to the design high water level; and for wet ponds 10 feet of vertical staging as measured from the seasonal high groundwater table to the design high water level, and shall have a horizontal bottom (no deep spots); and if during construction or operation of the stormwater management system, a structural failure is observed that has the potential to cause the direct discharge of surface water into the Floridan Aquifer System, corrective actions designed or approved by a registered professional shall be taken as soon as practical to correct the failure. A report prepared by a registered professional must be provided as soon as practical to the District for review and approval that provides reasonable assurance that the breach will be corrected.

## **PART VI – OPERATION AND MAINTENANCE**

### **6.1 General**

Applications to construct, alter, and maintain a stormwater management system also constitutes an application to operate and maintain the system. A permit to operate a system is granted concurrently with the permit to construct, maintain or alter the system. The operation phase of all ERP permits lasts for the life of the system. After a permit has been issued, construction of the permit shall follow the conditions of the permit and the rules and requirements as found in Chapter 62-330, F.A.C., and the Applicant’s Handbook Volume I. Transfer of the permit to the operation and maintenance phase shall follow the conditions of the permit and the rules and requirements found in Chapter 62-330, F.A.C., and the Applicant’s Handbook Volume I. Operation and maintenance of the system shall follow the conditions in the permit and the rules and requirements as found in Chapter 62-330, F.A.C., and the Applicant’s Handbook Volume I.

### **6.2 Entity Requirements**

In addition to the acceptable entities as found in Applicant’s Handbook Volume I, this District will allow the following entity:

Unincorporated associations of owners who share a surface water management system or who have portions or individual components of a larger surface water management system on their property are generally not acceptable operation and maintenance entities. However, for surface water management systems composed entirely of swales which are permitted to serve a private road or drive providing access to no more than five parcels of land, each larger than one acre, the District will accept such unincorporated associations. The District shall place limiting conditions on such permits to ensure current or future landowners understand that operation and maintenance of the surface water management system is the undivided responsibility of the owners.

The financial, legal, and administrative capability of a homeowners’ or property owners’ association to provide for the long-term operation and maintenance of a project, as required in Section 12.3.4 of Applicant’s Handbook Volume I, may be demonstrated by providing at least two years of copies of all meeting minutes, the names of the board of directors, copies of all operation and maintenance expenses incurred to date, and documentation showing that all levied assessments have been collected.

### **6.3 Operation Phase and Release of Bond**

Upon receipt of an as built certification package and transfer to operation and maintenance phase, the performance bond or surety will be released.

### **6.4 Inspections and Reporting**

Inspections and reporting shall be in accordance with Section 373.423, F.S., (2012), Chapter 62-330, F.A.C., and Applicant’s Handbook Volume I. The permittee and/or Operation and Maintenance entity, after receiving prior or reasonable notice, shall give permission and allow District personnel with proper identification, access to the project. District personnel shall inspect, sample, test, and review the project as necessary to ensure compliance with the specifications of the application and permit.

### **6.5 Compliance**

Complaints shall be processed as set forth in the Governing Board policy on compliance and enforcement.

### **6.6 Enforcement**

Parts I and IV of Chapter 373, F.S., provide for the enforcement of District rules by administrative and civil complaint. The District also has the authority to obtain the assistance of county and city officials in the enforcement of the rules in accordance with Sections 373.603 and 373.609, F.S. (2012). Any person who violates any provisions of Chapter 373 or 403, F.S., the rules adopted thereunder, or orders of the District, is subject to civil fines or criminal penalties as provided in Section 373.430, F.S. (2012) and the Governing Board policy on compliance and enforcement.

# District Boundary

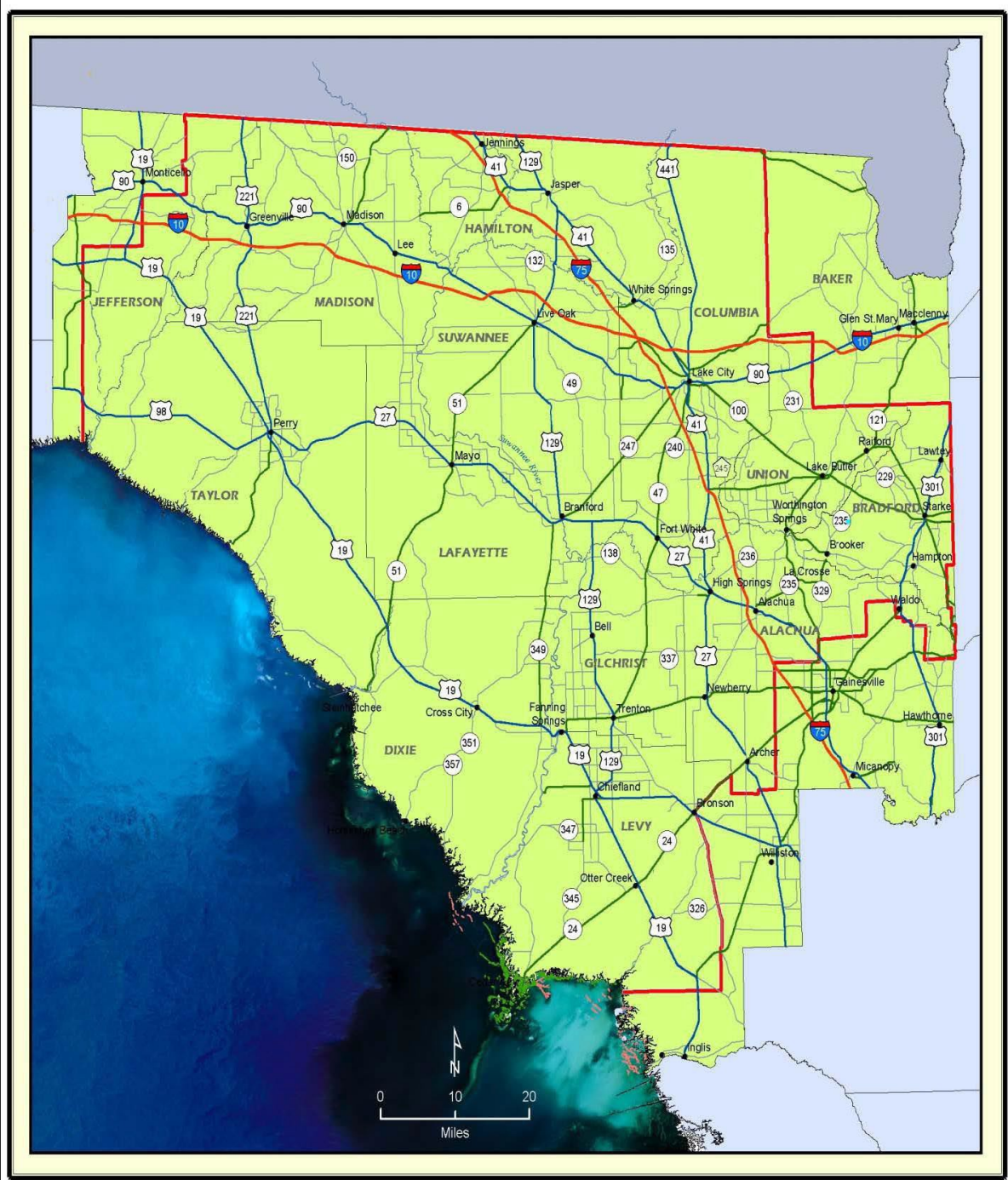

# Alachua County Boundary

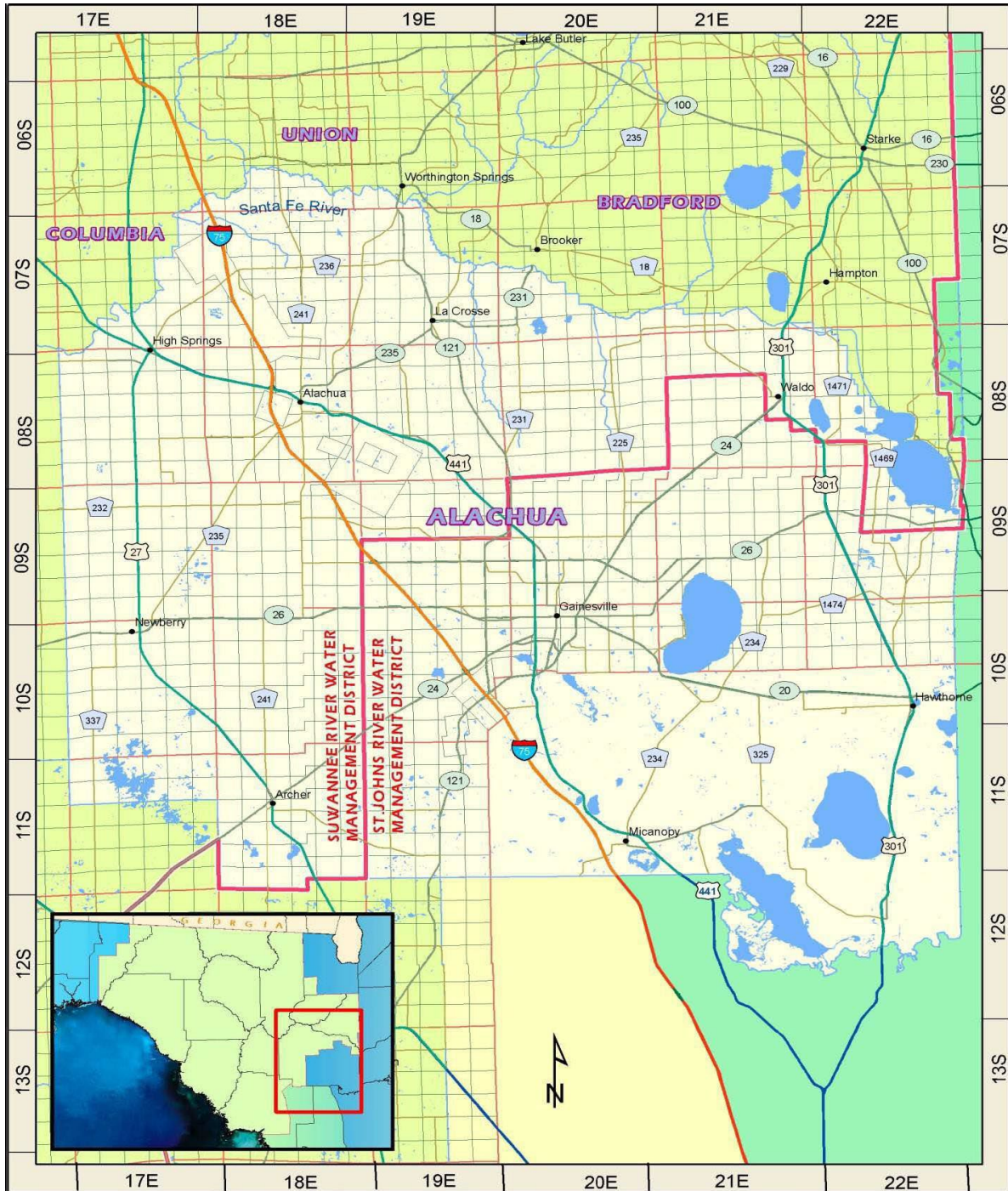

# Baker County Boundary

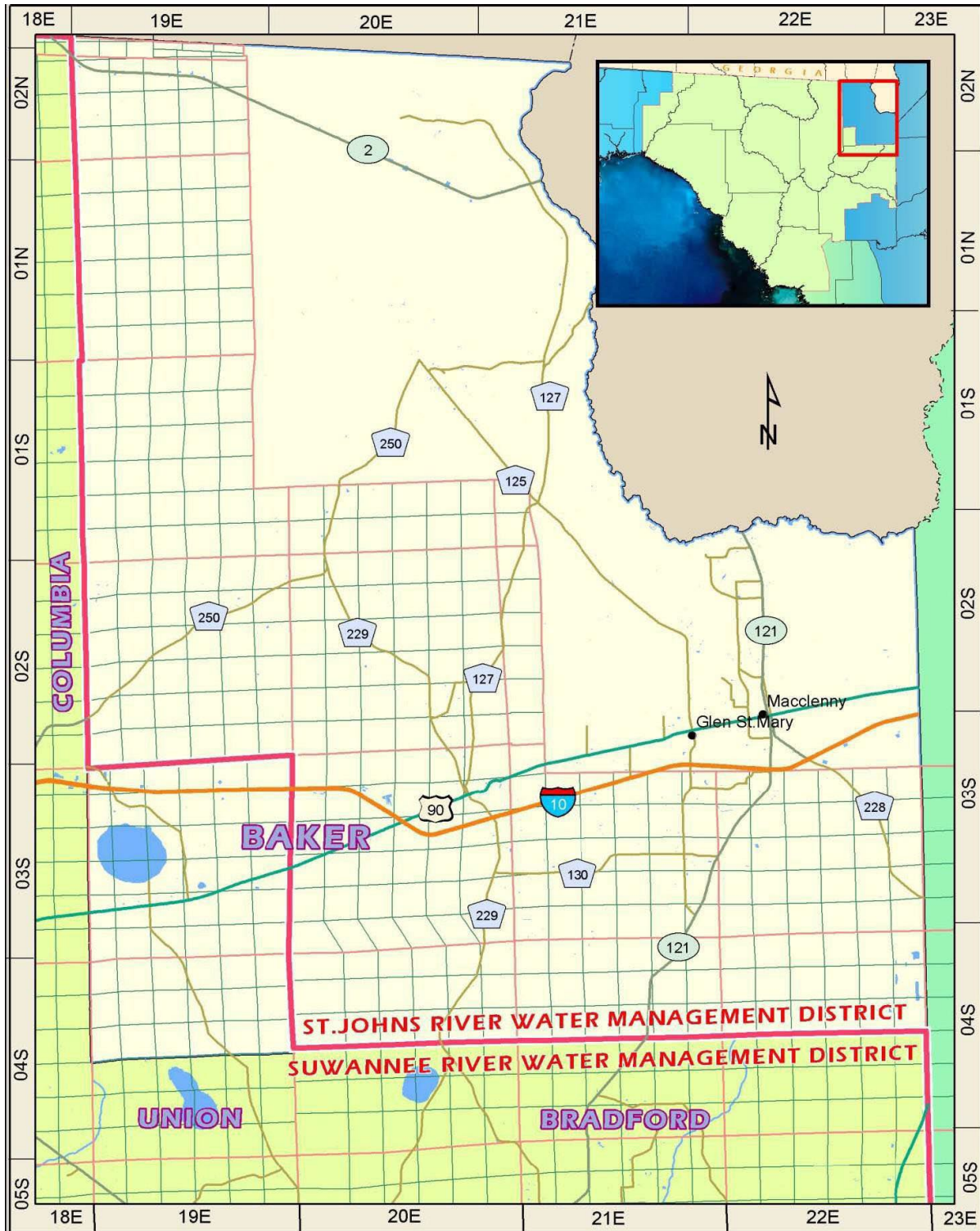

# Bradford County Boundary

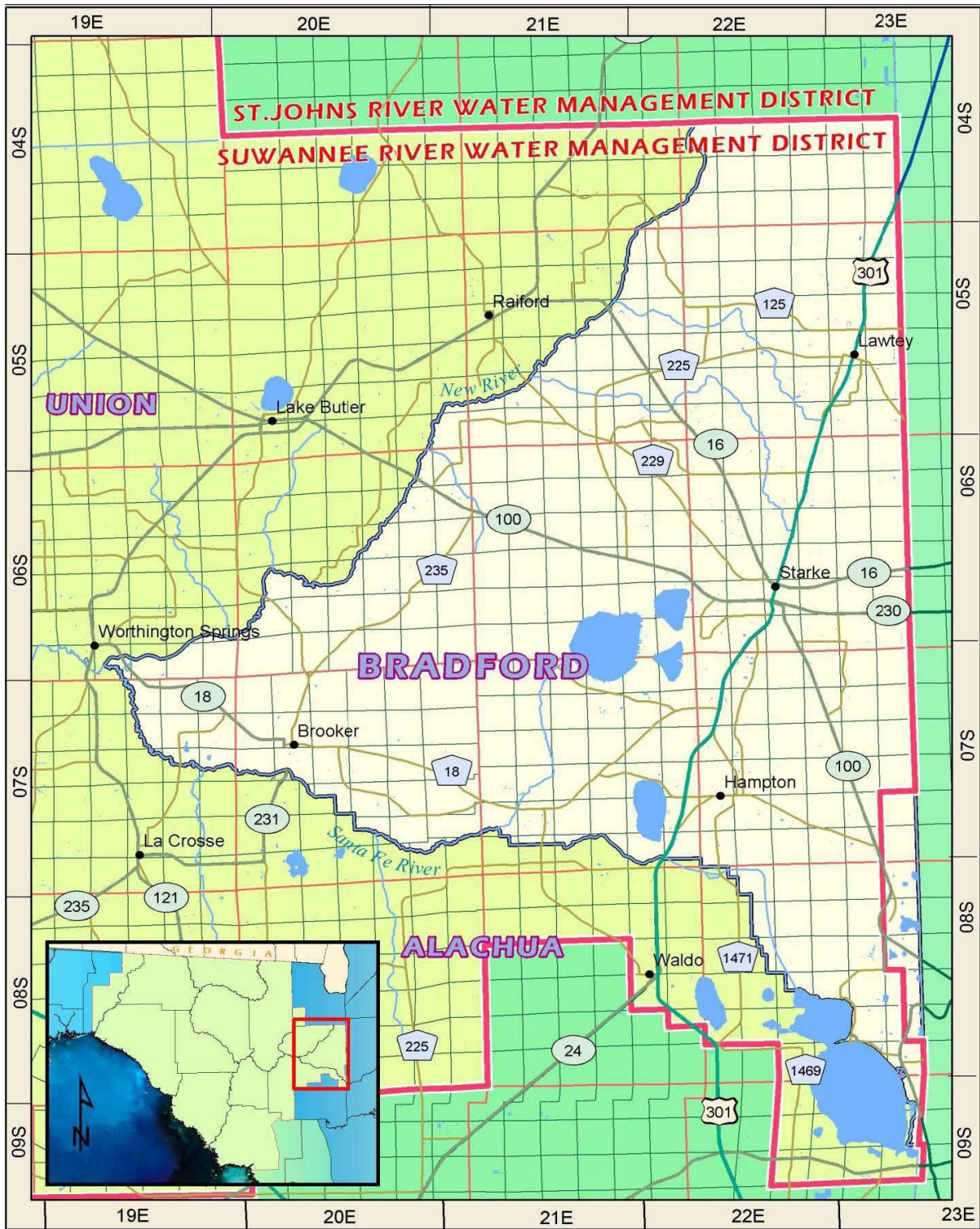

# Jefferson County Boundary

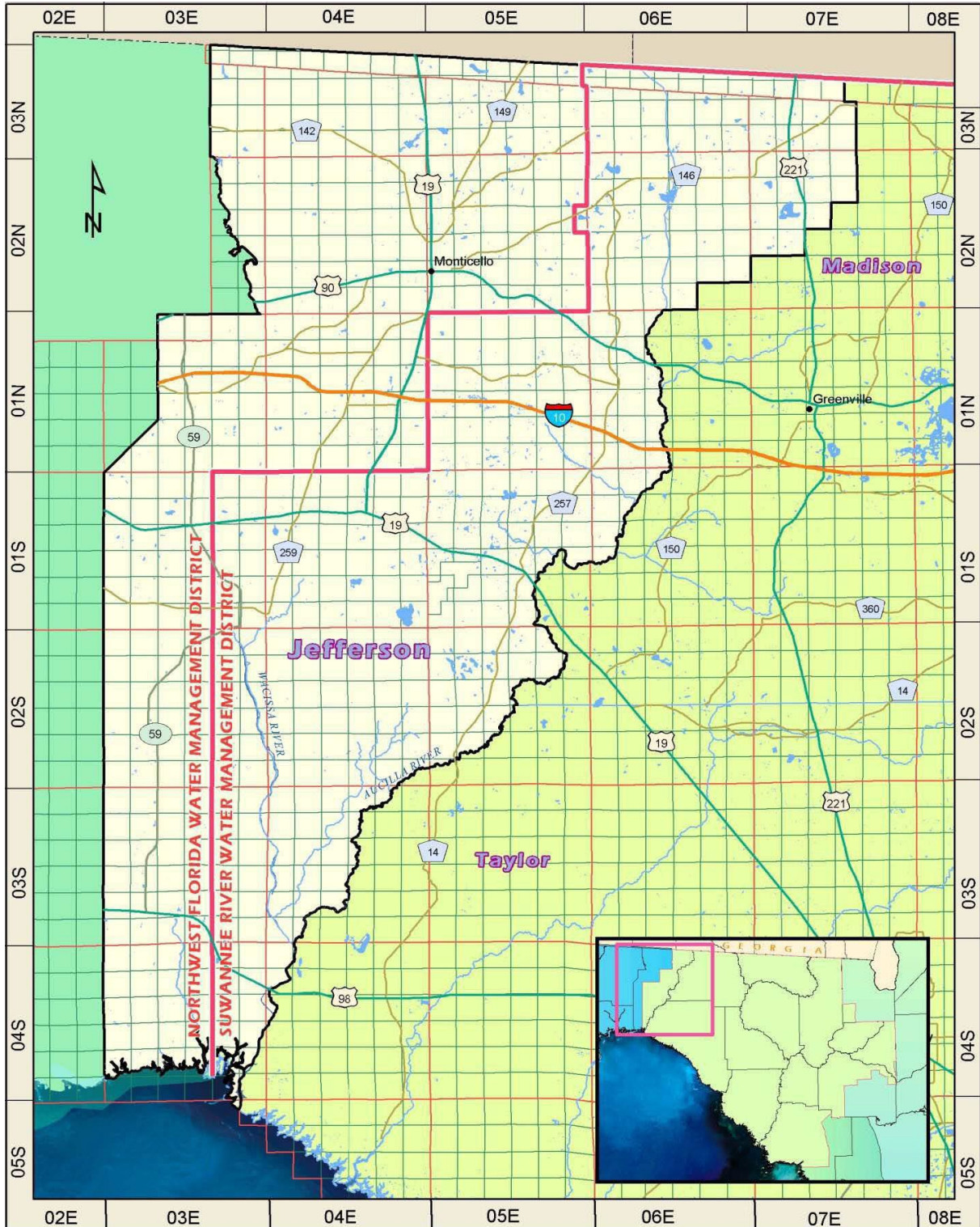

# Levy County Boundary

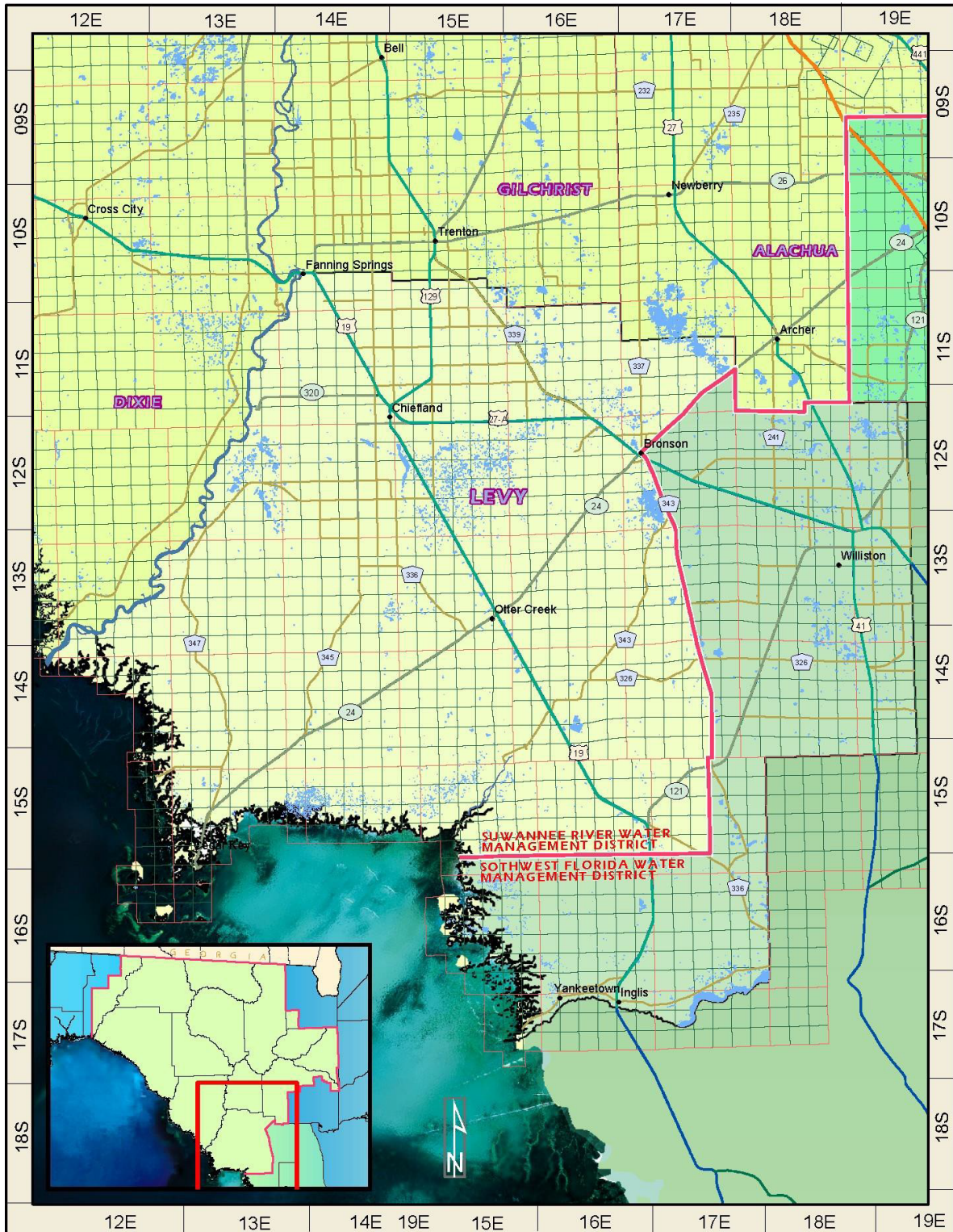



## Appendix B – Design Storms

### District Rainfall Distribution Data Values for

$P_{total}$  (inches)<sup>1</sup>

Total rainfall values shall be determined as follows:

For Baker, Columbia, Hamilton, Madison, Suwannee, and Union counties:

Frequency (years)	Duration (hours)							
	1	2	4	8	24	72	168	240
3	2.50	2.64	3.08	3.52	4.56	5.80	7.30	8.00
10	3.05	3.70	4.40	5.12	6.72	8.30	10.10	11.80
25	3.45	4.30	5.12	6.00	7.92	10.00	12.30	14.00
100	4.20	5.10	6.08	7.36	9.84	12.40	14.00	16.10

For Alachua, Bradford, Dixie, Gilchrist, Lafayette, Levy, and Taylor counties:

Frequency (years)	Duration (hours)							
	1	2	4	8	24	72	168	240
3	2.60	3.20	3.80	4.48	6.00	7.60	9.50	10.80
10	3.20	4.00	4.80	5.84	7.92	8.90	11.00	12.50
25	3.60	4.40	5.28	6.56	8.64	11.00	13.00	15.00
100	4.40	5.40	6.72	8.00	11.04	13.80	16.00	18.00

Applicants may either use the rainfall values above or the rainfall data from the National Oceanic and Atmospheric Administration Atlas 14, interpolated to the design storm durations in Section 3.2 if necessary.

#### 1- HOUR DURATION

T(hrs)	P/P <sub>total</sub>	I/P <sub>total</sub>
0	0	0
.1	.020	.200
.2	.080	.600
.3	.200	1.200
.4	.410	2.100
.5	.625	2.150
.6	.805	1.800
.7	.915	1.100
.8	.985	0.700
.9	.995	0.100
1.0	1.000	0

<sup>1</sup> Values for durations through 24 hours were taken from Florida Department of Transportation intensity curves. Values for durations greater than 24 hours were taken from National Weather Service Technical Paper No. 49, 1964.

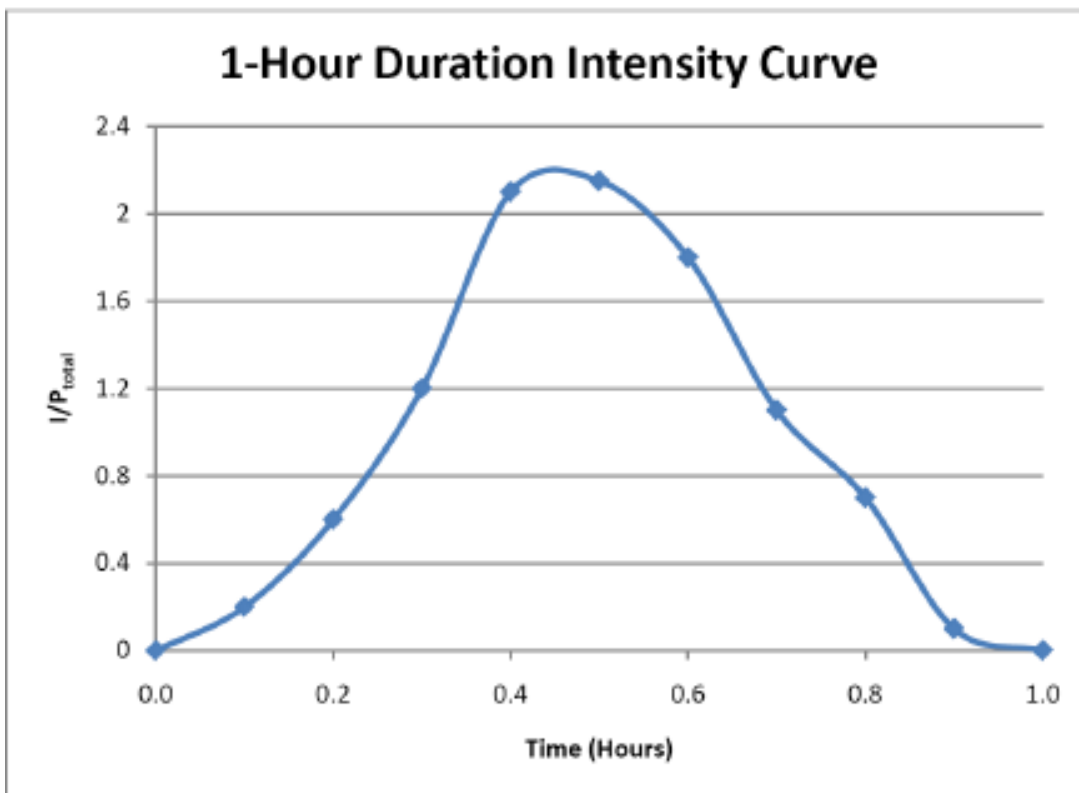
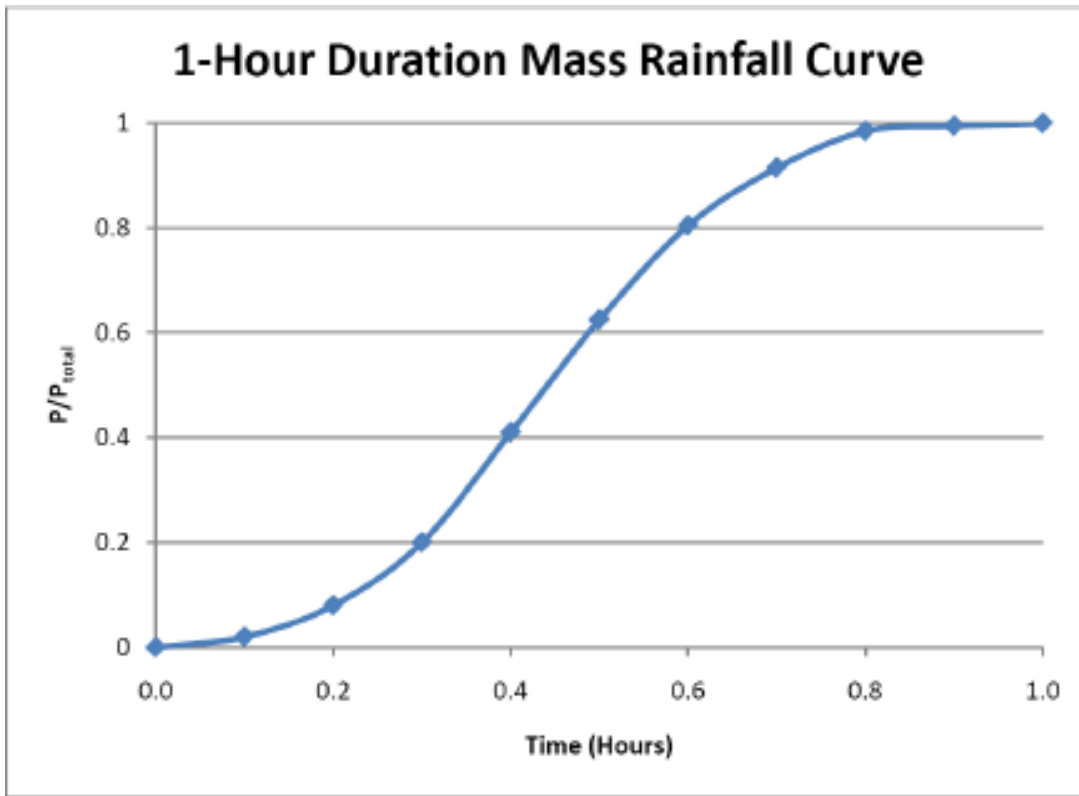

### 2- HOUR DURATION

T(hrs)	P/P <sub>total</sub>	1/P <sub>total</sub>
0	0	0
.2	.100	.500
.4	.250	.750
.6	.450	1.000
.8	.700	1.250
1.0	.800	.500
1.2	.860	.300
1.4	.910	.250
1.6	.950	.200
1.8	.980	.150
2.0	1.000	0

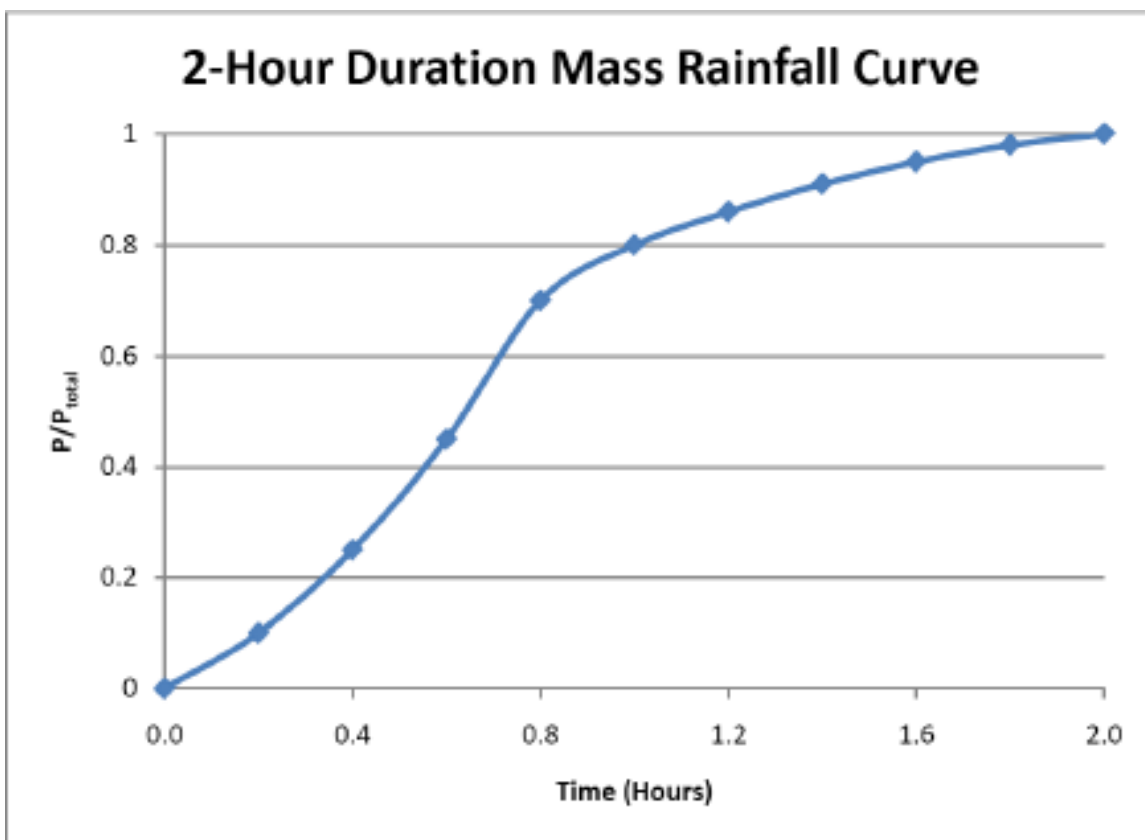

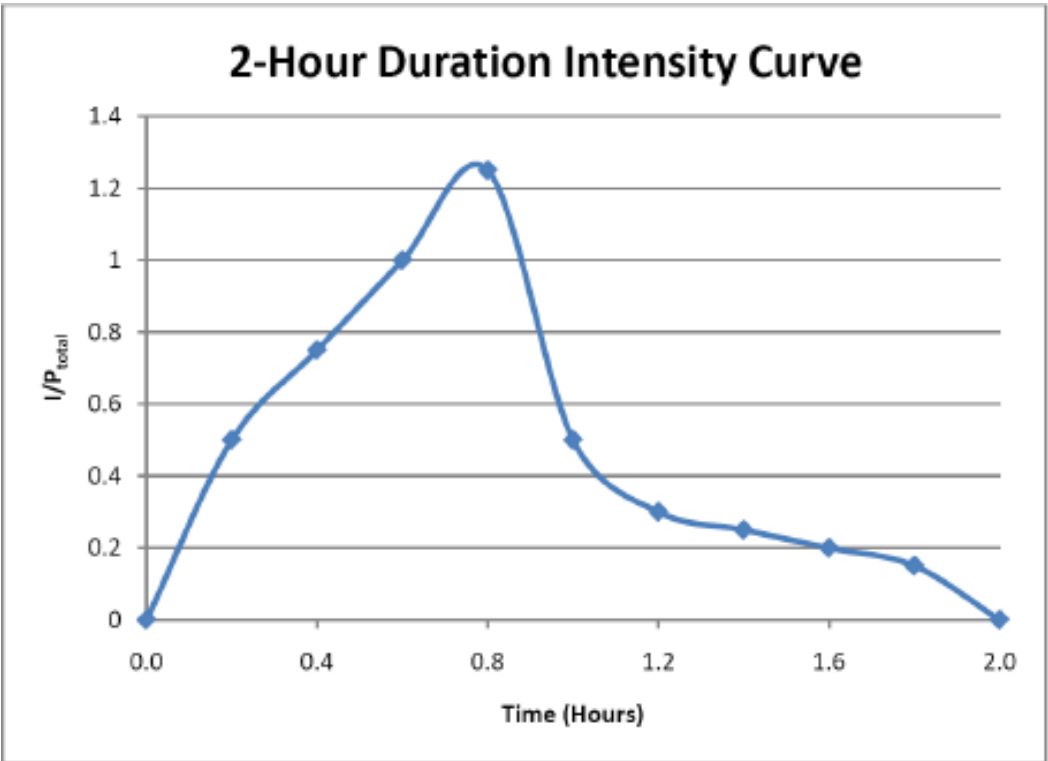

**4-HOUR DURATION**

T(hrs)	P/P <sub>total</sub>	I/P <sub>total</sub>
0	0	0
0.5	0.040	0.080
1.0	0.140	0.200
1.5	0.320	0.360
2.0	0.580	0.520
2.5	0.790	0.420
3.0	0.930	0.280
3.5	0.980	0.100
4.0	1.000	0

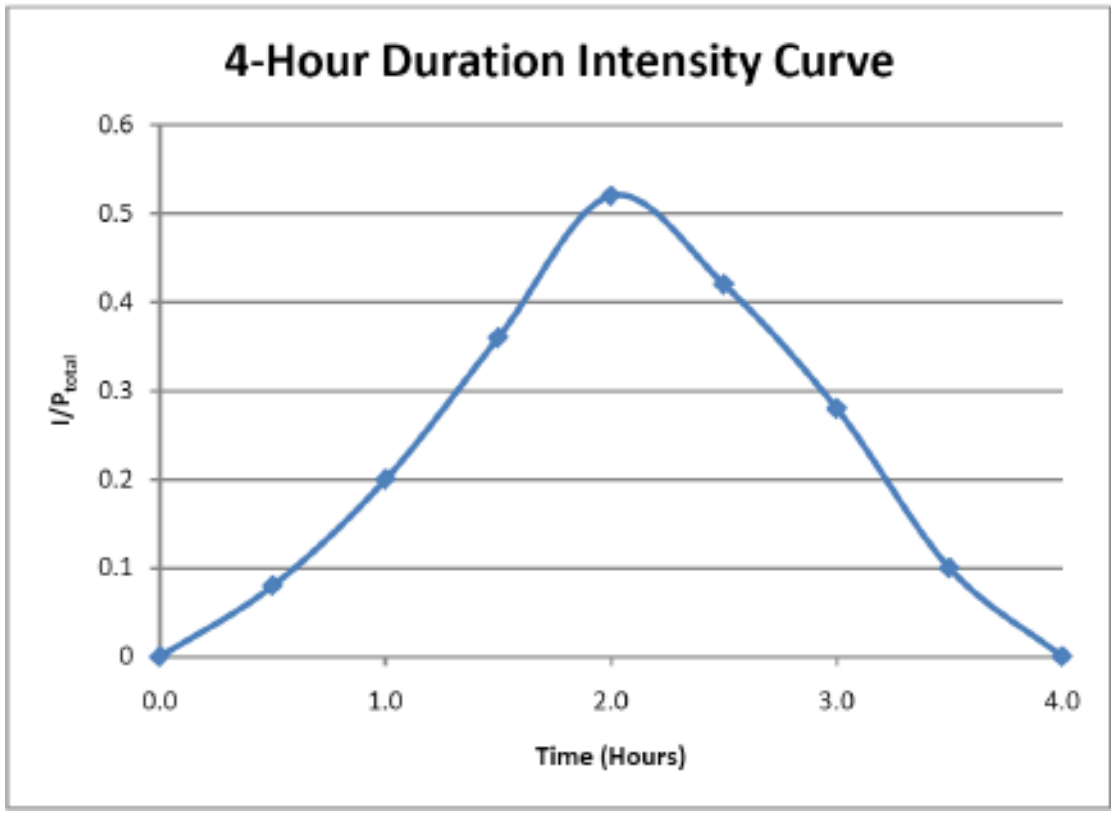
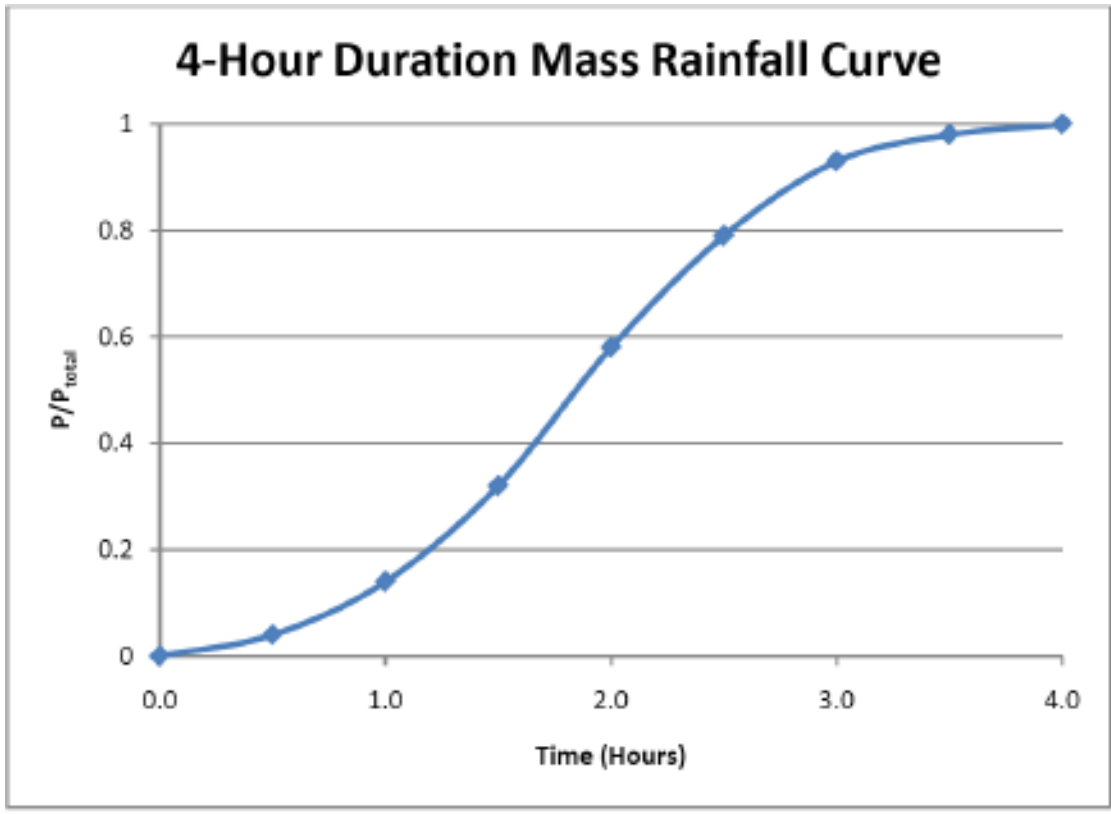

### 8-HOUR DURATION

T(hrs)	P/P <sub>total</sub>	1/P <sub>total</sub>
1	.020	.020
2	.130	.060
3	.280	.150
4	.700	.420
5	.860	.160
6	.920	.060
7	.970	.050
8	1.000	0

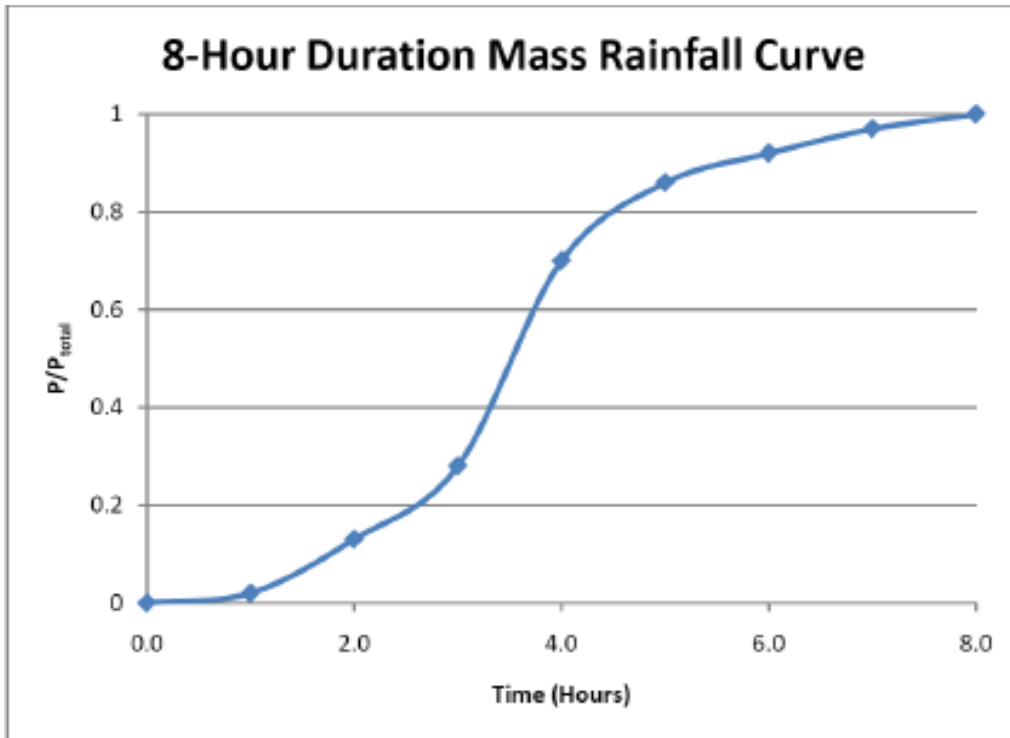

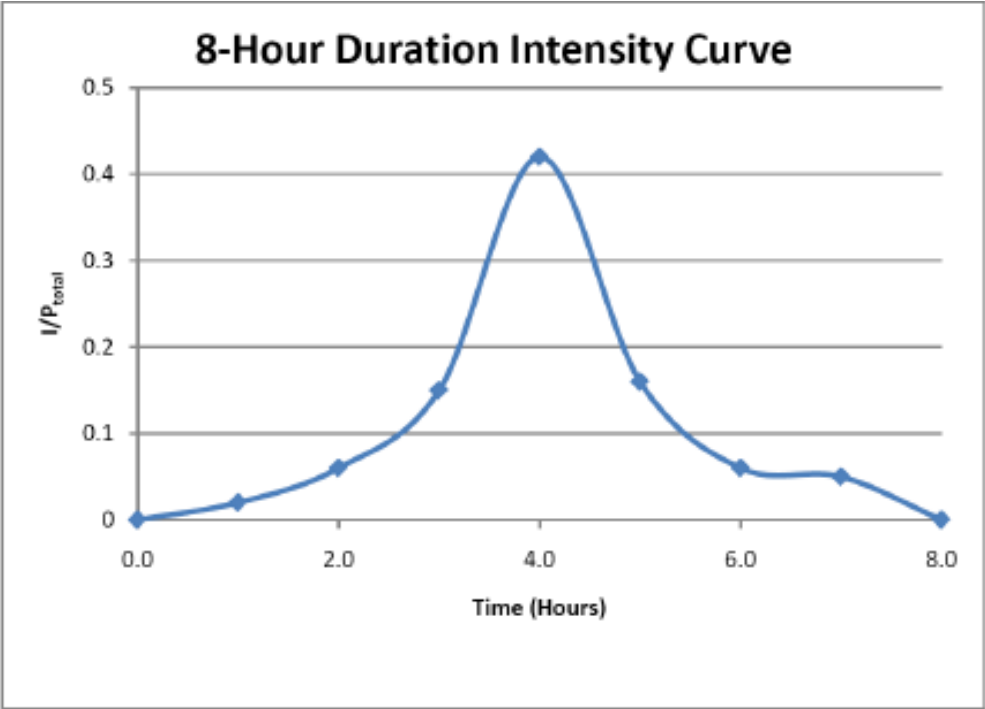

**24-HOUR DURATION**

T(hrs)	P/P <sub>total</sub>	1/P <sub>total</sub>
0	0	0
1	.010	.010
2	.030	.020
3	.060	.030
4	.090	.030
5	.120	.030
6	.160	.040
7	.200	.040
8	.240	.040
9	.300	.060
10	.360	.060
11	.440	.080
12	.540	.100
13	.610	.070
14	.670	.060
15	.730	.060
16	.780	.050
17	.820	.040
18	.860	.040
19	.900	.040
20	.930	.030
21	.960	.030
22	.980	.020
23	.990	.010
24	1.000	0

